

PORCELANOSA

NATURAL PRODUCTS

General Catalogue 2017

L'ANTIC COLONIAL

General Catalogue 2017

**”You must look ahead in
order to move forward.
You can only make progress
when you think big“**

”Sólo es posible avanzar cuando se mira lejos.
Sólo cabe progresar cuando se piensa en grande“

.....

”Regarder au loin pour mieux avancer.
En visant haut on ne peut que progresser“

José Ortega y Gasset



The Global Compact



The Global Compact is a voluntary initiative via which L'ANTIC COLONIAL S.A. and other participating companies undertake to align their operations and strategies with ten universally accepted principles in the areas of human rights, labour, the environment and anti-corruption. In terms of the number of participants, with six thousand in over 135 countries, the Global Compact is the world's largest corporate citizenship initiative. It is a framework for action aimed at boosting the social legitimacy of corporations and markets. Those companies that adhere to the Global Compact share the conviction that business practices based on universal principles contribute to building a more stable, equitable and inclusive global market that promotes more prosperous societies.

Businesses, trade and investment are basic cornerstones in ensuring peace and prosperity. However, in many areas, business is frequently associated with serious dilemmas such as exploitation, corruption, inequality and obstacles that hinder innovations and entrepreneurialism. Corporate social responsibility builds trust and social capital, while contributing to development and sustainable markets.

El Pacto Mundial es una iniciativa voluntaria, en la cual L'ANTIC COLONIAL S.A. junto a las demás empresas participantes se comprometen a alinear sus estrategias y operaciones con diez principios universalmente aceptados en cuatro áreas temáticas: derechos humanos, estándares laborales, medio ambiente y anti-corrupción. Por su número de participantes, seis mil en más de 135 países, el Pacto Mundial es la iniciativa de ciudadanía corporativa más grande del mundo. El Pacto es un marco de acción encaminado a la construcción de la legitimación social de las corporaciones y los mercados. Aquellas empresas que se adhieren al Pacto Mundial comparten la convicción de que las prácticas empresariales basadas en principios universales contribuyen a la construcción de un mercado global más estable, equitativo e incluyente que fomentan sociedades más prósperas.

Las empresas, el comercio y la inversión son pilares esenciales para la paz y prosperidad. Pero en muchas áreas las empresas están ligadas a serios dilemas, como pueden ser la explotación, la corrupción, la inequidad y otras barreras que frenan la innovación y el espíritu empresarial. Las acciones empresariales responsables construyen confianza y capital social, al mismo tiempo que contribuyen al desarrollo y mercados sustentables.

Le Pacte Mondial est une initiative à caractère facultatif dans le cadre de laquelle L'ANTIC COLONIAL S.A. et les autres entreprises participantes s'engagent à aligner leurs stratégies et opérations sur dix principes universellement admis dans quatre domaines thématiques : droits de l'homme, normes du travail, environnement et lutte contre la corruption. Le nombre de ses participants, six milles dans plus de 135 pays, fait du Pacte Mondial l'initiative de citoyenneté corporative la plus importante du monde. Le Pacte est un cadre d'action visant à la construction de la légitimation sociale des entreprises et des marchés. Les entreprises qui adhèrent au Pacte Mondial partagent la conviction que les pratiques commerciales et industrielles fondées sur des principes universels contribuent à la construction d'un marché global plus stable, équitable et intégrateur qui favorise une plus grande prospérité des sociétés.

Les entreprises, le commerce et les activités d'investissement constituent des piliers essentiels de la paix et de la prospérité. Mais les entreprises sont confrontées à de grands dilemmes dans de nombreux domaines, comme par exemple l'exploitation, la corruption, l'injustice et d'autres barrières qui freinent l'innovation et l'esprit d'entreprise. Les actions des chefs d'entreprise responsables développent la confiance et le capital social, tout en contribuant au bien-être et à des marchés plus durables.



Floor Coverings Amsterdam Hexagon Grey / Wall Coverings Persian White

COLLECTION INDEX / INDICE COLECCIONES / INDEX COLLECTIONNER

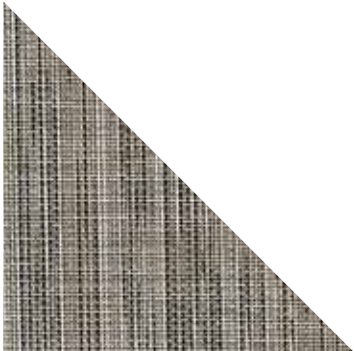
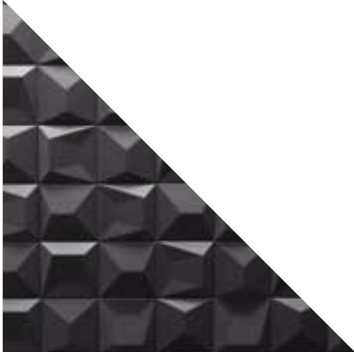

01 Natural Stone
02 Bathrooms
03 Mosaics

04 Ceramic Tiles
05 Natural Wood
06 Outdoor Decking

07 Laminate Flooring
08 Linkfloor

PRODUCT INDEX / INDICE PRODUCTOS / INDEX DES PRODUITS

A					
Advance 1L Blanco	437	Blanco Andes Pulido	30	Eden 1L Wenge	444
Advance 1L Marron	436	Blanco Andes Sand Home	31	Eden 1L White	446
Advance 1L Natural	437	Blanco Calacatta Pulido	98	Eden Texture 1L Almond	460
Advance 1L Warm Oak	436	Blue Sandstone Classico	71	Eden Texture 1L Cinamon	460
Advance Premium 1L Albany	440	Bombay Natural Home	77	Eden Texture 1L Honey	461
Advance Premium 1L Auckland	441	Bombay Pulido	77	Eden Texture 1L Nut	461
Advance Premium 1L Brisbane	440	Bordura Bisel Blanco	378	Edition Rectangular Gold	282
Advance Premium 1L Sidney	441	Boston	161	Edition Rectangular Grey	282
Aichi Browns	254	Buddha	129	Edition Rectangular White	282
Aichi Greys	254	C		Elements Mini Pattern Water	324
Aichi Mix Wood	254	Calgary Classico	58	Elements Mini Pattern Wind	324
Air Black	330	Calpe Black	382	Elements Pattern Earth	324
Air Dots Black	330	Calpe Blanco	382	Elements Pattern Mineral	324
Air Dots Black Matt	330	Calpe Concrete	383	Elements Pattern Water	324
Air Dots White	330	Calpe Nieve	383	Elements Pattern Wind	324
Air Dots White Matt	330	Calpe Seagreen	384	Elite Bhutan Copper	244
Air Hexagon Black	331	Calpe Warmgrey	384	Elite Bhutan Silver	244
Air Hexagon Black Matt	331	Capadocia Sand Home	32	Elite Brick Ariana	246
Air Hexagon White	331	Capuccino Grey Classico	39	Elite Brick Creams	246
Air Hexagon White Matt	331	Capuccino Grey Pulido	39	Elite Brick Silver Wood	246
Air White	330	Capuccino Pulido	38	Elite Brick Whites	246
Airslate Bombay	84	Capuccino Sand Home	38	Elite Capuccino Texture - Pul.	246
Airslate Delhi	84	Chennai White Flamed Home	52	Elite Even Burma	244
Airslate Forest	85	Chevron Ceniza	421	Elite Even Crema Grecia	244
Airslate Graphite	87	Chevron Cognac	421	Elite Lava Stone Brick Gold	245
Airslate Kashmir	86	Chevron Tobacco	420	Elite Lava Stone Brick Silver	245
Airslate Kathmandu	85	Chevron Vulcano	420	Elite Lava Stone Gold	245
Airslate Metal	86	Classic 1L Nogal	412	Elite Lava Stone Mix Gold Silver	244
Amsterdam 2D Hexagon Beige	66	Classic Ebano Luxor	412	Elite Lava Stone Mix Gold White	245
Amsterdam 2D Hexagon Grey	64	Classic Espiga Natura	413	Elite Lava Stone Silver	244
Amsterdam Beige	66	Classic Espiga Yute	413	Embellededor Piedra Lavabo	139
Amsterdam Grey	64	Clean&Green Active 0,5 L Laminado	552	Embellededor Piedra Plato Duchá	144
Amsterdam Hexagon Beige	67	Clean&Green Active 0,5 L Linkfloor	616	Embellededor Piedra Bañera	149
Amsterdam Hexagon Grey	65	Clean&Green Active 0,5 L Parquet	487	Encimera 110x52,5x2 cm	152
Amsterdam Wall Beige	67	Clean&Green Aqua Oil 1L Parquet	487	Encimera 160x60x2 cm	153
Amsterdam Wall Grey	65	Cola Blanca 750 Gr.	488	Encimera 80x52,5x2 cm	152
Ancient Bath	247	Cola Sic Flex 16 Kg	488	Encimera Faldon MLx52,5x10 cm	153
Ancient Earth	247	Core	135	Endless 1L Broadway	546
Arabia Gold	289	Cream Aged Anticato	61	Endless 1L Brooklyn	547
Arabia Mix Blue Silver	289	Crema Grecia Anticato	36	Endless 1L Long Island	547
Arabia Silver	289	Crema Grecia Classico	36	Endless 1L Queens	546
Arabia Sun	289	Crema Grecia Pulido	37	Essence	142
Arctic White Classico	33	D		Essential Basket Silver Wood	250
Arctic White Pulido	33	Dados Blue	284	Essential Basket Thassos	250
Armour Black	287	Dados Earth	284	Essential Chess Silver Wood	250
Armour Caramel	287	Dados Metal	284	Essential Chess Thassos	250
Art Berlin	325	Dados Pearl Cream	284	Essential Flag Thassos	250
Art New York	325	Delhi Natural Home	78	Essential Hexagon Persian White	251
Art Roma	325	Delhi Pulido	78	Essential Hexagon Silver Wood	251
Artisan 1L Coconut	432	Denia Black	382	Essential Mini Brick Persian White	251
Artisan 1L Linen	433	Denia Blanco	382	Essential Mini Brick Silver Wood	251
Artisan 1L Wild	432	Denia Concrete	383	Essential Stripes Silver Wood	250
Artisan 1L Woven	433	Denia Nieve	383	Eternity Cream	310
Aspen White Pulido	98	Denia Seagreen	384	Eternity Emperador	310
Aura Hexagon Creams	317	Denia Warmgrey	384	Eternity Grey	310
Aura Hexagon Whites	317	Desert Sandstone Classico	70	Eternity Mini Strip Cream	310
Authentic 1L Anthracite	479	Diverse Black	306	Eternity Mini Strip Emperador	310
Authentic 1L Bronze	479	Diverse Grey	306	Eternity Mini Strip Grey	310
Authentic 1L Chrome	478	Diverse White	306	Eternity Mini Strip White	311
Authentic 1L Pure	478	DQS Black	108	Eternity White	311
Azrama Primitive Vanity	196	DQS Grey	108	Evoke Black	290
Azrama Vanity Doors	197	DQS White	109	Evoke Caramel	290
Azrama Vanity Double	197	Dream Mix Whites	286	Evoke Form Black	290
Azrama Vanity Single	196	Dream White	286	Evoke Form Caramel	290
		Duomo Plus	130	Evoke Form Silver	290
				Evoke Silver	290
B		E		F	
Basic	136	Eden 1L Brown	444	Faces	179
Basic	143	Eden 1L Camel	445	Faces Bañera	179
Basic H40	138	Eden 1L Laguna	448	Faces Espejo Horizontal	180
Basic H84	138	Eden 1L Marengo	449	Faces Espejo Vertical	180
Basic Stand	129	Eden 1L Natural	446	Faces H1 Blanco	364
Bhutan Natural	74	Eden 1L Sand	447	Faces H1 Negro	364
Blanco Almeria Anticato	28	Eden 1L Venice	448	Faces H2 Blanco	364
Blanco Andes Classico	30				

PRODUCT INDEX / INDICE PRODUCTOS / INDEX DES PRODUITS

Faces H2 Negro	364	Glaze Micro Brick Black	276	Imperia Caramel	305
Faces H4 Blanco	364	Glaze Micro Brick Grey	276	Imperia Greys	305
Faces H4 Negro	365	Glaze Micro Brick White	276	Imperia Mix Silver Blacks	305
Faces H4 Oro	365	Glaze Mini Hexagon Black	276	Imperia Mix Silver Blue Blacks	305
Faces H4 Plata	365	Glaze Mini Hexagon Grey	276	Imperia Mix Silver Greys	304
Faces Mural	178	Glaze Mini Hexagon White	276	Imperia Mix Silver White	304
Faces S1 Blanco	366	Globe Brick Blanco Almeria	91	Imperia Nepal Bronze	304
Faces S1 Negro	366	Globe Brick Bombay	91	Imperia Onix Golden	304
Faces S3 Blanco	366	Globe Brick Buthan	91	Imperia White	304
Faces S3 Negro	366	Globe Brick Delhi	90		
Faces S3 Oro	367	Globe Brick Indira	90	J	
Faces S3 Plata	367	Globe Brick Lhasa	92	Javea Black	382
Faces S4 Blanco	366	Globe Brick Nepal	90	Javea Blanco	382
Faces S4 Negro	366	Globe Castle Burma	93	Javea Concrete	383
Faces S4 Oro	367	Globe Comer Blanco Almeria	91	Javea Nieve	383
Faces S4 Plata	367	Globe Comer Brick Bombay	91	Javea Seagreen	384
Faces Stand	178	Globe Comer Brick Buthan	91	Javea Warmgrey	384
Fidji Natural Home	79	Globe Comer Brick Delhi	90		
Fila Cleaner 1L	112	Globe Comer Brick Indira	90	K	
Fila Deterdek 1L	112	Globe Comer Brick Lhasa	92	Kathmandu Natural Home	80
Fila Fob 1L	112	Globe Comer Brick Nepal	90	Kathmandu Pulido	80
Fila HP98 1L	112	Globe Comer Stick Bhutan	92	Kayak Beige Classico	34
Fila Hydrorep 1L	112	Globe Comer Stick Mix Nepal Bhutan	93	Kayak Beige Pulido	34
Fila Longlife 1L	112	Globe Comer Stick Mix Nepal Shannan	93	Khoa	148
Fila Matt 1L	112	Globe Comer Stick Nepal	92	Kit Mantenimiento Highend Baths	112
Fila PS87 1L	112	Globe Stick Bhutan	92	Krabi	128
Fila Stone Plus 1L	112	Globe Stick Mix Nepal Bhutan	93		
Fila Wet 1L	112	Globe Stick Mix Nepal Shannan	93	L	
Flow Brick Black	280	Globe Stick Nepal	92	Lagos Black Home	53
Flow Brick Golden	280	Globe Wall Bhutan	94	Lamina Aislante Laminado	552
Flow Brick Tobacco	281	Globe Wall Burma	95	Lamina Aislante Linkfloor	616
Flow Brick White	280	Globe Wall Nepal	94	Lamina Aislante Parquet	486
Flow Hexagon Black	280	Globe Wall Shannan	95	Lamina Antihumedad + Espuma Laminado	552
Flow Hexagon Golden	280	Globe Wall White	94	Lamina Antihumedad + Espuma Linkfloor	616
Flow Hexagon Tobacco	281	Gravity Aluminium 3D Hexagon Gold	342	Lamina Antihumedad + Espuma Parquet	486
Flow Hexagon White	280	Gravity Aluminium 3D Hexagon Metal	342	Lamina Suelo Radiante Antiestática Laminado	552
Frame Brick Dark	323	Gravity Aluminium 3D Hexagon Rose Gold	343	Lamina Suelo Radiante Antiestática Linkfloor	616
Frame Brick Light	323	Gravity Aluminium Cubic Gold	342	Lamina Suelo Radiante Antiestática Parquet	486
Fusion 3D Caramel Mix	315	Gravity Aluminium Cubic Metal	342	Lavabo+Encimera+Boston	164
Fusion 3D Steel Mix	315	Gravity Aluminium Cubic Rose Gold	343	Lavabo+Encimera+Pducha 120 Cr: Italia	165
Fusion Brick 3D Caramel Mix	314	Gravity Aluminium Hexagon Gold	342	Lavabo+Encimera+Pducha 90 Cr: Italia	165
Fusion Brick 3D Steel Mix	314	Gravity Aluminium Hexagon Metal	342	Lavabo+Encimera Crema Italia	164
Fusion Brick 3D White	314	Gravity Aluminium Hexagon Rose Gold	343	Legacy Ceniza	417
Fusion Flat Caramel Mix	315			Legacy Cognac	417
Fusion Flat Steel Mix	315	H		Legacy Tobacco	416
Fusion Hexagon Caramel Mix	316	Habana Brown Classico	40	Legacy Vulcano	416
Fusion Hexagon Steel Mix	316	Habana Brown Pulido	40	Legend 1L Light	468
Fusion Hexagon White	316	Habana Brown Sand Home	41	Legend 1L Neutral	468
Fusion Mini Strip Caramel Mix	314	Habana Dark Classico	43	Lines Cambric Persian White Classico	248
Fusion Mini Strip Steel Mix	314	Habana Dark Pulido	43	Lines Cambric Persian White Pulido	248
Fusion Mini Strip White	314	Habana Grey Classico	42	Lines Cambric Silver Wood Classico	249
Fusion Triangles Caramel	316	Habana Grey Pulido	42	Lines Cambric Silver Wood Pulido	248
Fusion Triangles Steel	316	Hampton	160	Lines Mini Cambric Persian White Classico	248
Future	149	Harmony Arrow Coltan	291	Lines Mini Cambric Persian White Pulido	248
		Harmony Arrow Gold	291	Lines Mini Cambric Silver Wood Classico	249
G		Harmony Arrow Silver	291	Lines Mini Cambric Silver Wood Pulido	249
Geisha	131	Harmony Strip Coltan	291	Lines Safary Brown	249
Genuine 1L Great Basin	551	Harmony Strip Gold	291	Lines Safary White	249
Genuine 1L Mojave	550	Harmony Strip Silver	291	Lines Silver Wood Grey	248
Genuine 1L Sonoran	550	Hexcube Black	275	Linkfloor Contract Clay	570
Giallo Conte	100	Hexcube Blue	275	Linkfloor Contract Cotton	569
Glacier Moon Metallic Black	274			Linkfloor Contract Diamond	567
Glacier Moon Metallic Cremas	274	I		Linkfloor Contract Graphite	566
Glacier Moon Metallic White	274	Ibiza Concrete	374	Linkfloor Contract Gravel	570
Glaze Brick Black	277	Ibiza Concrete Gloss	375	Linkfloor Contract Iron	566
Glaze Brick Grey	277	Ibiza Dark	374	Linkfloor Contract Sand	569
Glaze Brick White	277	Ibiza Dark Gloss	375	Linkfloor Contract Steel	567
Glaze Dots Beiges Matt	279	Ibiza Grey	374	Linkfloor Contract Titanium	568
Glaze Dots Greys / Black Matt	279	Ibiza Grey Gloss	375	Linkfloor Contract Zinc	568
Glaze Dots Greys Matt	279	Ibiza Snow	374	Linkfloor Hotel Air Ash	613
Glaze Dots Whites Matt	279	Ibiza Snow Gloss	375	Linkfloor Hotel Air Earth	613
Glaze Hexagon Beiges Matt	278	Ibiza Steel	374	Linkfloor Hotel Air Maple	614
Glaze Hexagon Greys / Black Matt	278	Ibiza Steel Gloss	375	Linkfloor Hotel Air Mist	615
Glaze Hexagon Greys Matt	278	Ibiza White	374	Linkfloor Hotel Air Silver	614
Glaze Hexagon Whites Matt	278	Ibiza White Gloss	375	Linkfloor Hotel Air Walnut	612
		Imperia Bhutan Mirror	304	Linkfloor Hotel Air Wenge	612

PRODUCT INDEX / INDICE PRODUCTOS / INDEX DES PRODUITS

Linkfloor Loose Lay Contract Clay	596	Men(H)ir Stand	168	Outlines Brick Lhasa-Sha.-Burma	252
Linkfloor Loose Lay Contract Cotton	596	Metal Acero	336	Outlines Mini Strip Bhutan	252
Linkfloor Loose Lay Contract Diamond	597	Metal Acero Anthracite 3D Cubes	337	Outlines Mini Strip Canyon	253
Linkfloor Loose Lay Contract Graphite	597	Metal Acero Hexagon	336	Outlines Mini Strip Nepal	252
Linkfloor Loose Lay Contract Gravel	598	Metal Acero Hexagon Anthracite	336	Outlines Mini Strip Shannan	253
Linkfloor Loose Lay Contract Iron	598	Metal Acero Highlights	336		
Linkfloor Loose Lay Contract Sand	599	Metal Acero Highlights Golden	336	P	
Linkfloor Loose Lay Contract Steel	599	Metal Brick Acero	336	Paradise Arrow Blanco	258
Linkfloor Loose Lay Contract Titanium	600	Metal Bronze 3D Cubes	337	Paradise Arrow Gris	258
Linkfloor Loose Lay Contract Zinc	600	Metal Mini Cubes Dark	337	Paradise Arrow Negro	258
Linkfloor Oak Dark	606	Metal Mini Cubes Light	337	Paradise Baia Stone Blanco	256
Linkfloor Oak Grey	607	Mini Eden 1L Brown	455	Paradise Baia Stone Cremas	256
Linkfloor Oak Natural	606	Mini Eden 1L Camel	452	Paradise Baia Stone Negro	256
Linkfloor Oak White	607	Mini Eden 1L Dark Grey	456	Paradise Lake Stone Blanco	256
Linkfloor Roll Contract Clay	581	Mini Eden 1L Light Grey	456	Paradise Lake Stone Cremas	256
Linkfloor Roll Contract Cotton	580	Mini Eden 1L Marengo	454	Paradise Lake Stone Negro	256
Linkfloor Roll Contract Diamond	578	Mini Eden 1L Natural	452	Paradise Minibroken Edge Blanco	257
Linkfloor Roll Contract Graphite	576	Mini Eden 1L Sand	454	Paradise Minibroken Edge Negro	257
Linkfloor Roll Contract Gravel	581	Mini Eden 1L Wenge	457	Paradise Round Stone Blanco	257
Linkfloor Roll Contract Iron	576	Mini Eden 1L White	453	Paradise Round Stone Negro	257
Linkfloor Roll Contract Sand	580	Mini Eden Texture 1L Almond	464	Paradise Tinybroken Cubes Blanco	259
Linkfloor Roll Contract Steel	578	Mini Eden Texture 1L Cinamon	464	Paradise Tinybroken Cubes Negro	259
Linkfloor Roll Contract Titanium	579	Mini Eden Texture 1L Honey	465	Paradise Tinybroken Edge Blanco	258
Linkfloor Roll Contract Zinc	579	Mini Eden Texture 1L Nut	465	Paradise Tinybroken Edge Gris	258
Linkfloor Wall Contract Clay	589	Mini Iris Black Pearl	285	Paradise Tinybroken Edge Negro	258
Linkfloor Wall Contract Cotton	590	Mini Iris Cream Pearl	285	Patagonia Home	75
Linkfloor Wall Contract Diamond	587	Mini Iris Grey Pearl	285	Peldaño Técnico	114
Linkfloor Wall Contract Graphite	586	Mini Iris White Pearl	285	Peldaño Técnico Esquina Derecha	114
Linkfloor Wall Contract Gravel	589	Minim Encimera + Lavabo	186	Peldaño Técnico Esquina Izquierda	115
Linkfloor Wall Contract Iron	586	Minim Espejo 160x60 cm	187	Perfil Igualación Aluminio Laminado	553
Linkfloor Wall Contract Sand	590	Minim Espejo 80x80 cm	187	Perfil Igualación Aluminio Parquet	486
Linkfloor Wall Contract Steel	587	Minim Lavabo	184	Perfil Transición Aluminio Laminado	553
Linkfloor Wall Contract Titanium	588	Minim Lavabo + Encimera	185	Perfil Transición Aluminio Parquet	486
Linkfloor Wall Contract Zinc	588	Minim Lavabo Doble	185	Persian White Classico	29
LS 1L Africa	521	Minim Lavabo Stand	184	Persian White Pulido	29
LS 1L Amazon	521	Minim Wood	190	Phuket	128
LS 1L Blanco Decape	526	Minim Wood Doble	191	Port Cannes	101
LS 1L Boston	525	Minim Wood Encimera + Lavabo	192	Port Monaco	100
LS 1L Castaño Sunset	526	Minim Wood Lavabo + Encimera	191	Preparatore Pulep 10 L	488
LS 1L Ebano	520	Minim Wood Stand	190	Primer Pu31 10 L	488
LS 1L Illinois	522	Modern Multiformato Ceniza	408		
LS 1L Michigan Brown	522	Modern Multiformato Natural	408	R	
LS 1L Michigan Clear	523	Modern Multiformato Siena	409	Renaissance Bricks Black	320
LS 1L Michigan Dark Brown	520	Moka Anticato	46	Renaissance Bricks Silver Wood	320
LS 1L Michigan Grey	524	Moka Classico	46	Renaissance Bricks White	320
LS 1L Texas	524	Montreal Classico	59	Renaissance Lines Black	320
LS 1L Valley	523	Moon Marmara	255	Renaissance Lines Silver Wood	320
Luxe Mirror Cubes	283	Moon Mix Browns	255	Renaissance Lines White	320
Luxe Mirror Hexagon	283	Moon Mix Greys	255	Renaissance Squares Black	321
Luxe Mirror Strip	283	Moon Saturn Blanco	255	Renaissance Squares Silver Wood	321
Luxury Allure	261	Moon Silver Wood	255	Renaissance Squares White	321
Luxury Modul Copper	261			Residence 1L New Jersey	530
Luxury Modul Gold	261	N		Residence 1L Roble	531
Luxury Modul Silver	261	Nairobi Crema Classico	35	Residence 1L Roble Decape	531
Luxury Planet	261	Nairobi Crema Pulido	35	Residence 1L Vermont	532
		Natural 1L Amazon Light	516	Residence 1L Virginia	533
M		Natural 1L Ebano	514	Residence 2L Iowa	530
Magma Hexagon Beige	262	Natural 1L Loft	515	Residence 2L Maine	532
Magma Hexagon Black	262	Natural 1L Marron Decape	515	Residence 3L Ohio	533
Magma Hexagon Grey	262	Natural 1L Michigan Brown	516	Retro Blanco	378
Mamperlan Laminado	553	Natural 1L Michigan Clear	517	Revelation 1L Everglades	543
Mamperlan Parquet	486	Natural 1L Roble Life	517	Revelation 1L Katmai	543
Maya	137	Natural 1L Texas	514	Revelation 1L Yellowstone	542
Men(H)ir	168	Navona	135	Revelation 1L Yosemite	542
Men(H)ir Bañera	169	Nepal Natural	76	Revival 1L Cognac	472
Men(H)ir Encimera L	174			Revival 1L Dun	474
Men(H)ir Encimera S	174	O		Revival 1L Mahogany	472
Men(H)ir Espejo	171	Onix Botafogo	102	Revival 1L Ocher	473
Men(H)ir Espejo L	171	Onix Etnia	104	Revival 1L Oyster	473
Men(H)ir Espejo S	172	Onix Ipanema	103	Riverside Gold	379
Men(H)ir Estante D	170	Onix Lagoa	102	Riverside White	379
Men(H)ir Estante I	170	Onix Lava	104	Rmc Grease Remove 0,5 L	487
Men(H)ir Mueble L	173	Ottawa Pulido	63	Rmc Grease Remove 0,5 L	487
Men(H)ir Mueble S	173	Outlines Bars Capuccino Lin. Hom.	252	Rmc Limespot Remove 0,5 L	487
Men(H)ir Mueble S 3C	172	Outlines Bars Hab. Brown Lin. Hom.	252	Rmc Limespot Remove 0,5 L	487
		Outlines Brick Burma	252	Rmc Soap 1L	487

PRODUCT INDEX / INDICE PRODUCTOS / INDEX DES PRODUITS

Rmc Soap Satin 1L	487	Styledeck Plus Grey	498	Victorian Mother of Pearl White	269
Rmc Surface Care 750 mL	487	T		Victorian Trenzado Marmara Gris	269
Rmc Surface Care 750 ML	487	Tecno Bhutan Silver Glass	308	Victorian Trenzado Marmara Negro	268
Rmc Uni. Maint. Oil Voc Free Color 0,5 L	487	Tecno Br Bhutan Silver Glass	308	Vintage	217
Rmc Uni. Maint. Oil Voc Free Color 0,5 L	487	Tecno Br Nepal Golden Glass	308	Vintage Espejo L	218
Rmc Uni. Maint. Oil Voc Free Pure 0,5 L	487	Tecno Glass Country	309	Vintage Espejo S	218
Rmc Uni. Maint. Oil Voc Free Pure 0,5 L	487	Tecno Linear Brown Capuccino	309	Vintage L	216
Romo Retro Blanco	378	Tecno Linear Cream Capuccino	309	Vintage S	216
Round	137	Tecno Linear Cream Habana	309	W	
S		Tecno Linear Silver White	308	W-Tower	160
Sahara Anticato	60	Tecno Nepal Decor	308	Wood Boxes	348
Saint Denis Espejo Place	212	Tecno Nepal Golden Glass	308	Wood Brick	349
Saint Denis Espejo Tour	213	Tecno Quarz Emerald	309	Wood Cubes	348
Saint Denis Lavabo	212	Tecno Quarz Mountain	309	Wood Even	348
Saint Germain Espejo Étagère	208	Time Text. Linear Black	319	Wood Feel	348
Saint Germain Espejo Place	209	Time Text. Linear Cream	319	Wood Lovers 1L Brown	482
Saint Germain Espejo Tour	208	Time Text. Linear Silk Wood	319	Wood Lovers 1L Brown Lisbon	482
Saint Germain Lavabo	206	Time Text. Linear Silver Wood	319	Wood Lovers 1L Grey Newman	482
Saint Germain Structure	207	Time Text. Linear White	319	Wood Lovers 1L Grey Night	482
Saint Germain Totem	206	Time Text. Silk Wood	318	Wood Lovers 1L Natural	482
Saint Germain Totem Crochet	207	Time Text. silver Wood	318	Wood Lovers 1L Warm Ocean	482
Samara	148	Time Texture Black	318	Wood Modul	349
Samui	142	Time Texture Cream	318	Wood Square Aged	348
Shape	136	Time Texture White	318	Wood Square Aged 3D	348
Sherpa Brown Home	54	Tortona 1L Borgo	429	Wood Square Antique	349
Shima	131	Tortona 1L Fiera	424	Wood Top 110	154
Signature Tile Copper	370	Tortona 1L Fonte	425	Wood Top 160	154
Signature Tile Cream Glossy	370	Tortona 1L Palazzo	427	Wood Top 80	155
Signature Tile Cream Matt	370	Tortona 1L Piazza	428	Wood Wall Anthracite	350
Signature Tile Mud	371	Tortona 1L Strada	428	Wood Wall Bronze	350
Signature Tile Shell	371	Tortona 1L Viale	426	Wood Wall Chrome	350
Signature Tile Silver	370	Tortona 1L Walnut	426	Wood Wall Pure	350
Signature Tile Smoke	371	Tortona 1L Wenge	424	Wood Wall Teak	351
Signature Tile White Glossy	370	Toscano Anticato	47	World Amsterdam Brick Beige	243
Signature Tile White Matt	370	Treasures Bronz. Emper.	312	World Amsterdam Brick Grey	243
Silk Wood Classico	49	Treasures Bronz. Emper.	312	World Beige	242
Silver Wood Classico	48	Treasures Bronz. Emper. Moon	312	World Blanco Almeria	242
Skyline City Beige	260	Treasures Bronz. Emper. Strip	312	World Crema Italia	242
Skyline City Earth	260	Treasures Mist Shannan	313	World Hexagon Text. Grey	242
Skyline City Volcano	260	Treasures Mist Shannan	313	World Random Nepal	242
Skyline Linear Broken Dark	260	Treasures Mist Shannan Moon	313	World Random Shannan	242
Skyline Mix Broken Dark	260	Treasures Mist Shannan Strip	313	Z	
Skyline Trial Delhi	260	Trend	134	Zen	143
Soporte Encimera 150x55 cm	156	Trend Stripes Browns	322	Zen Wood	132
Soporte Encimera 70x47,5 cm	156	Trend Stripes Greys	322	Zeno	134
Soporte Encimera Forma	156	Trend Stripes Whites	322	Zocalo Laminado Blanco	553
Soporte Encimera Recto	156	Tribal Pearl Black	307	Zócalo Parquet Blanco	486
Soul Hollow	130	Tribal Pearl Brown	307		
Spirit Espejo Neboa	201	Tribal Pearl White	307		
Spirit II Espejo	201	U			
Spirit II Lavabo	200	Urban Grey	293		
Spirit Lavabo	200	Urban Grey Frost	293		
Spirit Mueble	202	Urban Line Copper	292		
Stark Black	288	Urban Line Iron	292		
Stark Grey	288	Urban Line Lead	292		
Stark White	288	Urban Line Nickel	292		
Statuario Altísimo	99	Urban Line Silver	292		
Stone Basin Countertop 400 Angled	222	Urban Line Zinc	292		
Stone Basin Countertop 400 Straight	222	Urban Retro Iron	294		
Stone Basin Wall Mounted 400	223	Urban Retro Lead	294		
Stone Basin Wall Mounted 600	224	Urban Retro Nickel	294		
Stone Basin Wall Mounted 800	224	Urban Retro Silver	294		
Stone Freestanding Bathtub	225	Urban White	293		
Stone Mirror 1200x1000	227	Urban White Frost	293		
Stone Mirror 1600x1000	227	V			
Stone Mirror 800x1000	226	Vancouver Classico	62		
Stone Mirror D 950	226	Victorian Blanco Marmara	268		
Style 1L Calm	537	Victorian Chain Marmara Mirror	268		
Style 1L Mild	536	Victorian Chain Marmara-Marquina	268		
Style 1L Quiet	537	Victorian Diamond Marmara-Mirror	268		
Style 1L Smooth	536	Victorian Island Star White	268		
Style 1L Soft	538	Victorian Mother of Pearl Brown	269		
Styledeck Plus Brown	499	Victorian Mother of Pearl Grey	269		
Styledeck Plus Dark	498				



NATURAL STONE

L'Antic Colonial stone is a natural product which may be subject to shade variations. The colour of the material supplied may differ slightly from that shown.

Our website (<http://anticcolonial.com/piedra-natural/en/natural-stone/>) contains further information in respect of our stone products, such as installation guides and videos, technical data sheets, details on larger format, textures or recommendations for use.

Todas las piedras de L'Antic Colonial son productos naturales que pueden sufrir variaciones de tono. El color del material servido puede no ser exactamente igual al de la muestra.

En nuestra página web (<http://anticcolonial.com/piedra-natural/>) encontrará información adicional de nuestras piedras como guías y vídeos de instalación, fichas técnicas, tablas de mayor formato, texturas o recomendaciones de uso.

Toutes les pierres de L'Antic Colonial sont des produits naturels qui peuvent subir des variations de tonalité. La couleur du matériau fourni peut être légèrement différente de celle de l'échantillon.

Sur notre site Internet (<http://anticcolonial.com/fr/pierre-naturelle/>), vous trouverez des informations supplémentaires sur nos pierres: manuels et vidéos d'installations, fiches techniques, tableaux avec les formats disponibles, textures ou recommandations d'utilisation.

NATURAL STONE / PIEDRA NATURAL / PIERRE NATURELLE



Floor Coverings Amsterdam Beige / Wall Coverings Amsterdam Wall Beige

NATURAL STONE / PIEDRA NATURAL / PIERRE NATURELLE

REMEMBER

All natural products are perfectly imperfect. The differences found between pieces make each piece unique and unrepeatable. This feature is **NOT A PRODUCT DEFECT** but an inherent part of the beauty of the product.

If we are able to convey an understanding of the features of our products, we are sure that we will be able to meet all your expectations as regards quality and beauty. This is why it is essential that you are aware that you are buying a natural product, the characteristics of which may, on occasions, include:

1.- Pinhole cavities filled with grout

The surface of some materials, as for example the travertines, is covered with pinhole cavities. These cavities are treated with a grout, as similar as possible in colour to that of the stone. This characteristic is part of the nature of the product and at no time is it a sign of a defective product.

2.- Repaired fissures or cracks

It is normal for small cracks to appear on the surface of the stones. These are repaired with resins. This helps to strengthen the stone and increase its subsequent performance. This characteristic occurs frequently in natural products and should be taken into account when selecting products for a project.

3.- Changes in shade

All the natural products vary in shade and in the structure of the piece. The pieces undergo an exhaustive sorting process at L'Antic Colonial and any that do not meet our exacting quality standards are rejected. Possible variations are listed in the technical specifications of the products. If you have chosen one of our products for your project, we suggest you request photos of the panels or a few square metres of sample before making your purchase.

“IF YOU INVEST IN BEAUTY, IT WILL REMAIN WITH YOU FOR THE REST OF YOUR LIFE”

Frank Lloyd Wright

A TENER EN CUENTA

Todos los materiales naturales son perfectamente imperfectos. La variación existente entre piezas hace que cada una de ellas sea única e irreplicable. Esta característica **NO ES UN DEFECTO DEL MATERIAL** sino una parte inherente de la belleza del producto.

Si somos capaces de trasladarle las características de nuestros productos estamos convencidos que cubriremos sus expectativas en cuanto a calidad y belleza. Por ello es muy importante que entienda que está comprando un producto natural cuyas características incluyen en algunos casos:

1.- Coqueas rellenas de masilla

Algunos materiales, como por ejemplo los travertinos, presentan coqueas en su superficie. Estas cavidades se tratan con una masilla del color posible más parecido al de la piedra. Esta característica forma parte del material y en ningún momento indica que se trata de un producto defectuoso.

2.- Fisuras o grietas reparadas

En la superficie de las piedras suelen aparecer grietas que son reparadas con resinas. De este modo se refuerza la pieza y se aumenta su rendimiento posterior. Esta característica es muy común en la mayoría de productos naturales y se debe tener en cuenta a la hora de seleccionarlos para un proyecto.

3.- Variación de tonalidad

Todos los materiales naturales varían tanto en tono como en la propia estructura de la pieza. Desde L'Antic Colonial se realiza una exhaustiva clasificación mediante la que se eliminan los elementos que no superan nuestros estándares de calidad.

En las fichas técnicas de nuestros productos se muestran las posibles variaciones de los mismos. Si ha seleccionado uno de nuestros materiales para su proyecto, le recomendamos que solicite imágenes de las tablas o unos metros cuadrados de muestra antes de realizar la compra.

“SI INVIERTES EN BELLEZA, ÉSTA TE ACOMPAÑARÁ EL RESTO DE TU VIDA”

Frank Lloyd Wright

À PRENDRE EN COMPTE

Tous les matériaux naturels sont parfaitement imparfaits. La variation existante entre les pièces les rend uniques. Cette caractéristique **N'EST PAS UN DÉFAUT DU MATÉRIAU** mais une part inhérente de la beauté du produit.

Si nous sommes capables de vous transmettre les caractéristiques de nos produits, nous sommes persuadés que nous répondrons à vos attentes en termes de qualité et beauté. Pour cela il est très important que vous compreniez que vous achetez un produit naturel dont les caractéristiques incluent dans certains cas:

1.- Alvéole remplies d'enduit

Certains matériaux, comme par exemple les travertins, présentent des alvéoles en surface. Ces cavités sont traitées avec un enduit d'une couleur la plus proche possible de la pierre. Cette caractéristique est inhérente au matériau et n'indique absolument pas qu'il s'agit d'un produit défectueux.

2.- Fissures ou craquelures réparées

Des fissures apparaissent souvent sur la surface des pierres et sont traitées avec des résines. La pierre est ainsi renforcée et son rendement ultérieur accru. Cette caractéristique est très commune sur la majorité des produits naturels et doit être prise en compte au moment de la sélectionner pour un projet.

3.- Variation de tonalité

Tous les matériaux naturels varient à la fois au niveau du ton et de la structure même de la pièce. Chez L'Antic Colonial nous procédons à un classement exhaustif qui permet d'éliminer les éléments qui ne répondent pas à nos standards de qualité.

Sur les fiches techniques de nos produits sont indiquées leurs variations éventuelles. Si vous avez sélectionné l'un de nos matériaux pour votre projet, nous vous recommandons de demander des images des lames ou quelques mètres carrés d'échantillon avant de réaliser votre achat.

“SI VOUS MISEZ SUR LA BEAUTÉ, ELLE VOUS ACCOMPAGNERA LE RESTE DE VOTRE VIE”

Frank Lloyd Wright



Bioprot

A new waterproofing process for stone which improves the qualities of natural stone. The layer, which to date has only been applied to the upper surface, is now applied to the remaining faces of each of the pieces on the L'Antic Colonial production line. As a result, all sides, including the underside of the piece, now possess the same qualities as the surface.

This technological advance stems from research aimed at completely protecting all L'Antic Colonial pieces from the possible effects of glues, adhesives or the floor's moisture content, both at the time of installation and with the least possible effect over time.

It should be borne in mind that all natural stone, depending on type, has a degree of porosity, which is an intrinsic characteristic of natural stone. With this new process, we have sought to protect the faces so that external factors do not alter the qualities of natural stone.

El nuevo proceso de impermeabilización de la piedra mejora las características propias de la piedra natural. A la capa aplicada hasta ahora sobre la superficie útil, se le suma el mismo proceso en el resto de caras de cada una de las piezas que pasan por la línea de producción de L'Antic Colonial, con lo que todos los laterales de la pieza y la cara inferior de la misma pieza, acaban teniendo las mismas características que hasta ahora tenía sólo la cara superficial.

La evolución viene dada por la búsqueda de la protección total de cada una de las piezas que produce L'Antic Colonial, y así evitar que cualquier posible afectación por las colas, cementos o humedades del suelo en el momento de la instalación, afecten el mínimo posible con el paso del tiempo.

No hay que olvidar que en función del tipo de piedra natural, esta tiene un grado de porosidad, característica intrínseca de la piedra natural, con lo que con este nuevo proceso, lo que se busca es la protección de la superficie para que los agentes externos no alteren las características de la misma piedra natural.

Le nouveau processus d'imperméabilisation de la pierre améliore les caractéristiques propres à la pierre naturelle. Outre la couche appliquée jusqu'à présent sur la surface utile, le même procédé est ajouté à toutes les autres parties de chacune des pièces qui passent par la ligne de production de L'Antic Colonial. Par conséquent, tous les côtés et la face inférieure des pièces ont désormais les caractéristiques que possédaient jusqu'à présent la partie superficielle uniquement.

Cette évolution est le fruit de la recherche d'une protection totale pour chacune des pièces produites par L'Antic colonial. L'objectif est de faire en sorte que les éventuels défauts dus aux colles, aux ciments, à l'humidité du sol au moment de la pose aient un impact minimum sur la durée.

Il est important de savoir qu'en fonction du type de pierre naturelle, celle-ci a un degré de porosité, ce qui est l'une de ses caractéristiques intrinsèques. Le but est de protéger la surface pour que les agents externes altèrent le moins possible ses caractéristiques.



FORMATS / FORMATOS / FORMATS

MULTIFORMATO 40,6x61cm / 40,6x40,6cm / 20x40,6cm / 20x20cm
MULTIFORMAT 16"x24" / 16"x16" / 7 7/8"x16" / 7 7/8"x7 7/8"

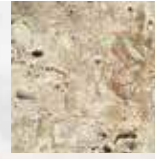

160x60cm
63"x23 5/8"



40x80cm
15 3/4"x31 1/2"



30x60cm
11 3/4"x23 5/8"



10x60cm
3 7/8"x23 5/8"

FORMATS / FORMATOS / FORMATS

120x240cm
47 1/4"x94 1/2"

SLAB / TABLA 2cm / 3cm
3/4" / 1 1/8"

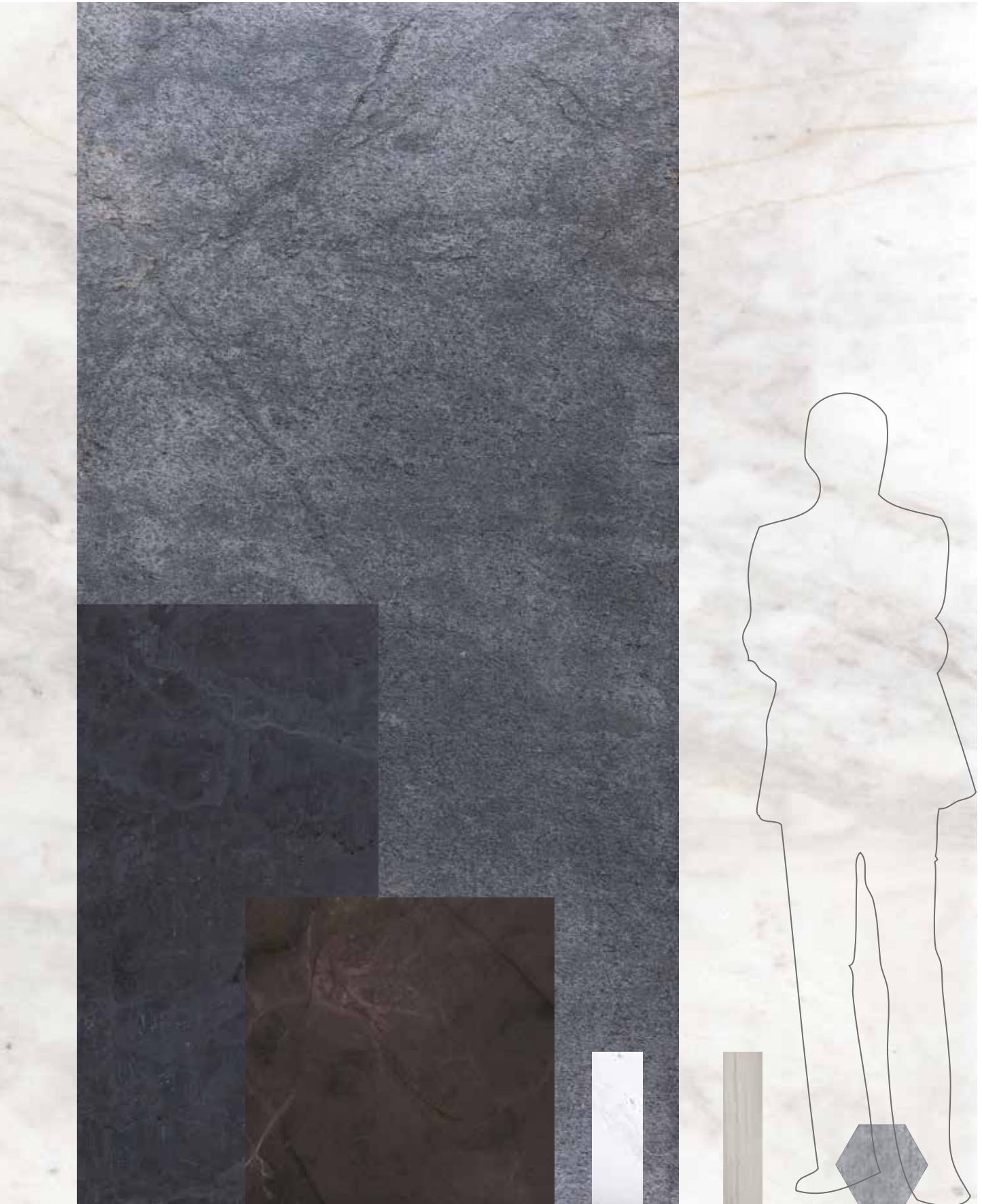

120x60cm
47 1/4"x94 1/2"

60x60cm
23 5/8"x23 5/8"

9,8x30cm
3 7/8"x11 3/4"

7,5x30cm
3"x11 3/4"

19x19cm
7 1/2"x7 1/2"

FINISHES / ACABADOS / FINITIONS

**ANTI-KATO**

The stone is naturally aged to give it a warm, traditional look.

Las piezas se envejecen de manera natural para conseguir una estética cálida y tradicional.

Les pièces sont vieillies de façon naturelle pour obtenir une esthétique chaude et traditionnelle.

**TEXTURE**

A natural, rustic finish with a rough, grooved texture is achieved by pounding the stone with pointed machine heads.

Acabado rústico y natural con textura estriada y rugosa logrado por medio del golpeo con cabezales en forma de punta.

Finition rustique et naturelle d'une texture striée et rugueuse, obtenue en frappant le matériau avec des têtes en forme de pointes.

**FLAMED**

Featuring a rough texture, achieved through exposure to fire.

Textura rugosa conseguida con la exposición al fuego.

Texture rugueuse obtenue par exposition au feu.

**FLAMED HOME**

Featuring a rough texture, achieved through exposure to fire and mechanical brushing.

Textura rugosa conseguida con la exposición al fuego y cepillada mediante cepillos mecánicos.

Texture rugueuse obtenue par exposition au feu et brossage au moyen de brosses mécaniques.

**SAND FINISH**

Featuring a rough surface achieved by sandblasting stone.

Conseguimos superficie de rugosidad mediante chorro de arena.

Surface à rugosité obtenue par j



HOME

very slightly
e, achieved
ing the

una
fina
diante
ena.

rugosité
et de sable.

NATURAL

The natural relief surface of slate and quartzite is conserved, although the inner sides are calibrated to make the stone easy to lay.

En pizarras y cuarcitas se conserva el relieve natural de la piedra, a su vez, la cara interior se calibra para optimizar su instalación.

Sur les ardoises et les quartzites, conserve le relief naturel de la pierre. En même temps, la face intérieure est calibrée an d'optimiser sa pose.

CLASSICO

Featuring a mechanically achieved satin finish.

Se caracteriza por un acabado satinado conseguido por procedimientos mecánicos.

Se caractérise par une finition satinée obtenue en appliquant des procédés mécaniques.

PULIDO

Featuring a mechanically achieved high-gloss finish.

Se caracteriza por un alto brillo conseguido por procedimientos mecánicos.

Se caractérise par un brillant élevé obtenu en appliquant des procédés mécaniques.

HOME

Through mechanical brushing, a smooth, satin, silky finish is achieved. Practical and easy to care for, it can be used on walls and floors.

Por medio de cepillos mecánicos se logra un acabado sedoso, suave y satinado, muy práctico y de fácil mantenimiento tanto para paredes como para suelos.

Des brosses mécaniques permettent d'obtenir une finition soyeuse, douce et satinée, très pratique et facile à nettoyer, aussi bien sur les murs que sur les sols.

COLOR RANGE / GAMA DE COLORES / GAMME DE COULEURS

WHITE



BLACK

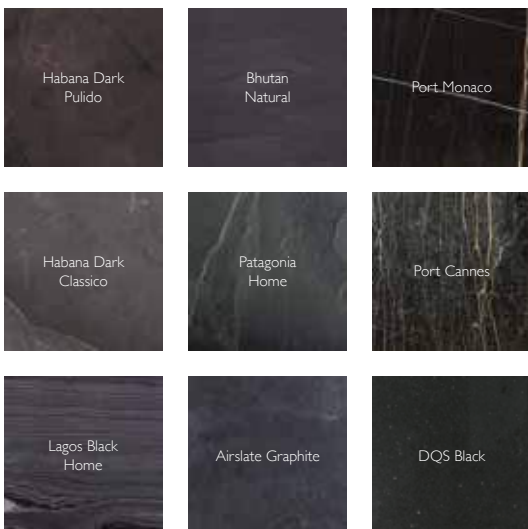

BROWN

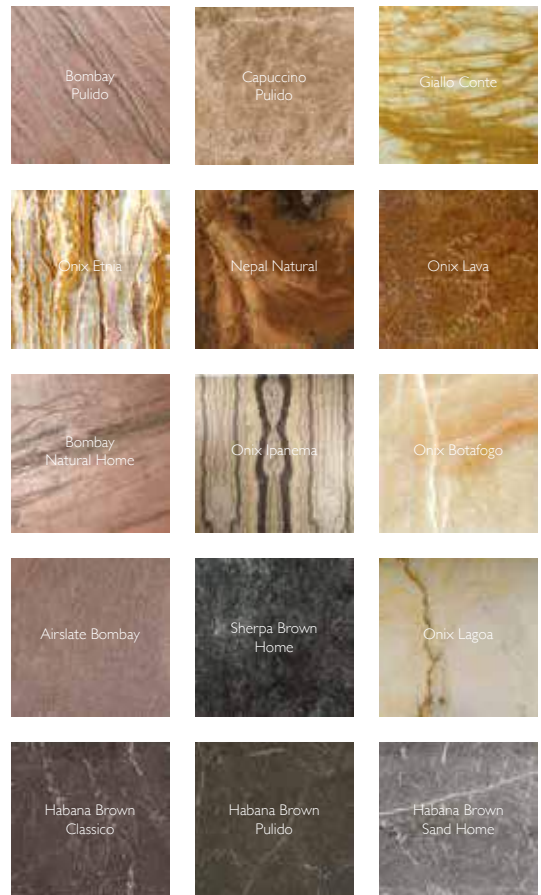

COLOR RANGE / GAMA DE COLORES / GAMME DE COULEURS

GREY

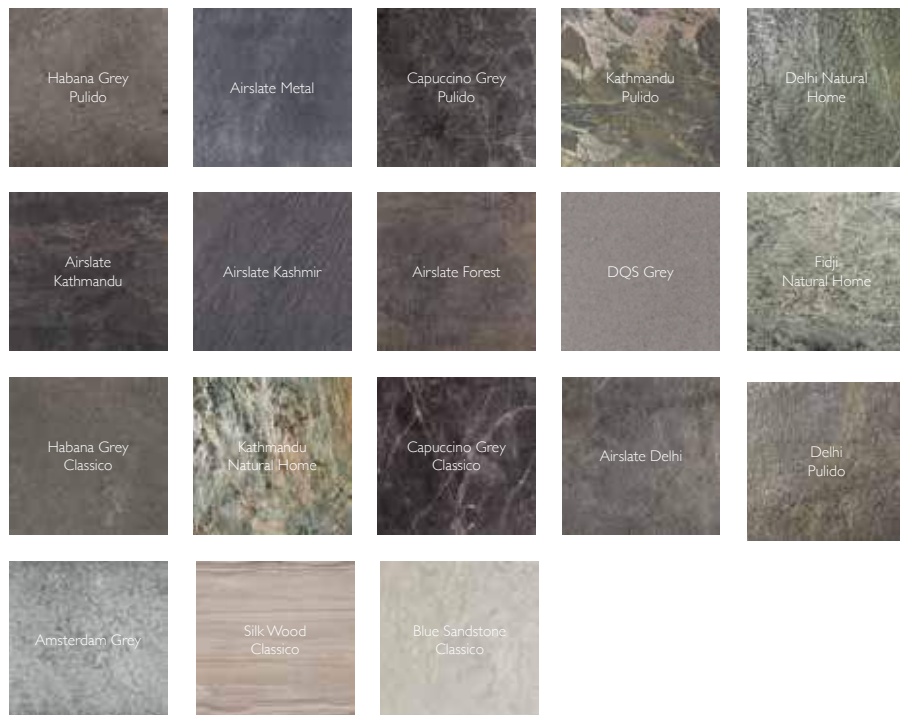

BEIGE

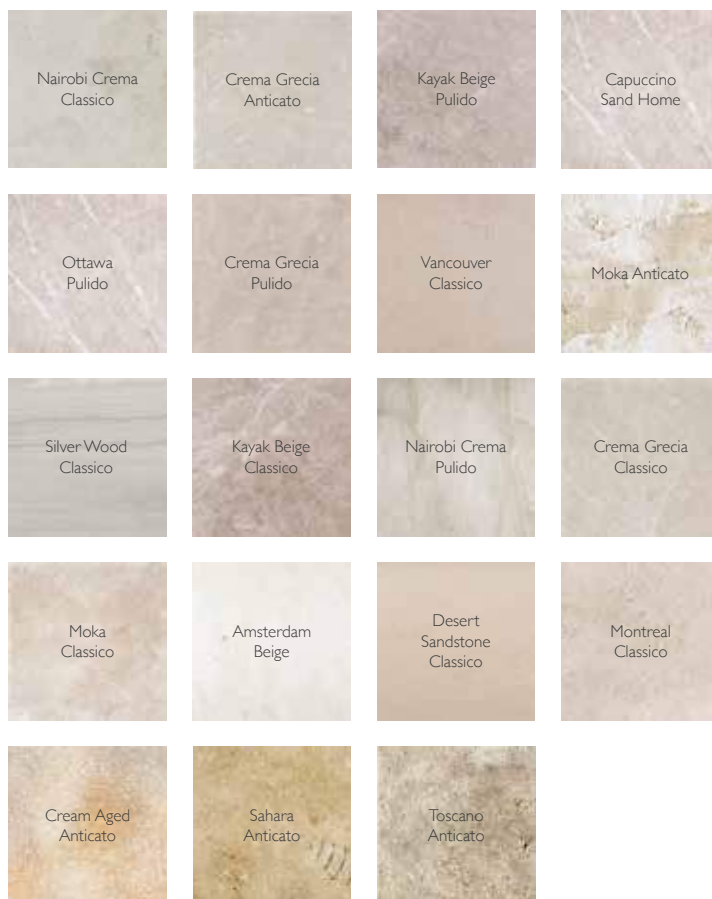

DESCRIPTION OF ICONS / DESCRIPCIÓN DE ICONOS / DESCRIPTION DES ICONES



IRREGULAR TEXTURE

Material that stands out for having an asymmetrical surface.

TEXTURA IRREGULAR

Material que destaca por tener una superficie asimétrica.

TEXTURE IRRÉGULIÈRE

Matériau qui se distingue par sa surface asymétrique.



GLOSS

Material with surface with the ability to produce reflections.

BRILLO

Material cuya superficie tiene la capacidad de producir reflejos.

ÉCLAT

Matériau dont la surface est en mesure de produire des reflets.



MATT

Material with a gloss-free surface.

MATE

Material cuya superficie carece de brillo.

MAT

Matériau dont la surface n'est pas brillante.



BEVEL

Beveled cut on all 4 edges of the piece for emphasizing size and preventing quick damage due to the material wear and tear.

BISEL

Corte oblicuo realizado en los 4 bordes de la pieza para resaltar el tamaño y evitar el rápido deterioro por desgaste en el material.

BISEAU

Coupe oblique réalisée sur les 4 bords de la pièce pour en mettre valeur la dimension et éviter la détérioration rapide due à l'usure du matériau.



BIOPROT

Protection that reduces drastically the emergence of most common household bacteria.

Protección que reduce radicalmente la aparición de las bacterias domesticas mas comunes.

Protection qui réduit de façon radicale l'apparition des bactéries domestiques les plus communes.



STRONG COLOR VARIATION

There are considerable color changes between pieces.

VARIACIÓN DE TONO FUERTE

Existen cambios de color importantes entre piezas.

FORTE VARIATION DE TONALITÉ

Il existe d'importants changements de couleur entre les pièces.



MODERATE COLOR VARIATION

There are consistent color changes between pieces.

VARIACIÓN DE TONO MODERADA

Existen cambios de color regulares entre piezas.

VARIATION DE TONALITÉ MODÉRÉE

Il existe des changements de couleur réguliers entre les pièces.



SLIGHT COLOR VARIATION

There are slight color changes between pieces.

VARIACIÓN DE TONO LIGERA

Existen cambios de color suaves entre piezas.

LÉGÈRE VARIATION DE TONALITÉ

Il existe de légers changements de couleur entre les pièces.



NO COLOR VARIATION

No changes in color between pieces.

SIN VARIACIÓN DE TONO

Sin cambios de color entre piezas.

SANS VARIATION DE TONALITÉ

Sans changement de couleur entre les pièces.



LOW TRAFFIC

Material only suitable for low-traffic floors (private setting).

BAJO TRANSITO

Material indicado sólo para suelos con poco trasiego (ámbito privado).

FAIBLE PASSAGE

Matériau indiqué uniquement pour les revêtements de sols de pièces à faible passage (domaine privé).



MEDIUM TRAFFIC

Material suitable for floors with a considerable use (private setting in high-traffic rooms).

MEDIO TRANSITO

Material indicado para suelos con un uso considerado (ámbito privado en estancias con mucho uso).

PASSAGE MOYEN

Matériau indiqué pour les sols utilisés fréquemment (domaine privé dans des pièces très utilisées).



HIGH TRAFFIC

Material suitable for floors with constant use (public setting).

ALTO TRANSITO

Material indicado para suelos con un uso constante (ámbito público).

PASSAGE ÉLEVÉ

Matériau indiqué pour les sols utilisés constamment.



ORIGIN EUROPE

Material from a European country.

PROCEDENCIA EUROPA

Material procedente de algún país europeo.

PROVENANCE EUROPÉENNE

Matériau en provenance d'un pays européen.



ORIGIN AMERICA

Material from an American country.

PROCEDENCIA AMÉRICA

Material procedente de algún país americano.

PROVENANCE AMÉRICAINNE

Matériau en provenance d'un pays d'Amérique.



ORIGIN ASIA

Material from an Asian country.

PROCEDENCIA ASIA

Material procedente de algún país asiático.

PROVENANCE ASIATIQUE

Matériau en provenance d'un pays asiatique.

DESCRIPTION OF ICONS / DESCRIPCIÓN DE ICONOS / DESCRIPTION DES ICONES



INDOOR FLOORING

Material suitable for use on indoor floors.

PAVIMENTO INTERIOR

Material apto para su uso en suelos de interior.

REVÊTEMENT DE SOL INTÉRIEUR

Matériau qui convient aux sols d'intérieur.



INDOOR WALL COVERING

Material suitable for use on indoor walls.

REVESTIMIENTO INTERIOR

Material apto para su uso en paredes de interior.

REVÊTEMENT INTÉRIEUR

Matériau qui convient aux murs d'intérieur.



COUNTERTOPS

Material suitable for use on countertops.

ENCIMERAS

Material apto para su uso en encimeras.

PLANS DE TRAVAIL/TOILETTE

Matériau qui convient aux plans de travail/toilette.



OUTDOOR FLOORING

Material suitable for use on outdoor floors.

PAVIMENTO EXTERIOR

Material apto para su uso en suelos de exterior.

REVÊTEMENT DE SOL EXTÉRIEUR

Matériau qui convient aux sols d'extérieur.



OUTDOOR WALL COVERING

Material suitable for use on outdoor walls.

REVESTIMIENTO EXTERIOR

Material apto para su uso en paredes de exterior.

REVÊTEMENT EXTÉRIEUR

Matériau qui convient aux murs d'extérieur.



RAMP CLASSIFICATION

Slip-resistance index as per current legislation.

CLASIFICACIÓN EN RAMPA

Índice de resbaladidad según la normativa vigente.

CLASSIFICATION SUR RAMPE

Indice de glissance conformément à la réglementation en vigueur.



POOL - SPA

Material suitable for use on permanently wet areas.

PISCINA - SPA

Material apto para su uso en zonas permanentemente húmedas.

PISCINE -SPA

Matériau qui convient aux zones toujours humides.



POOL SURROUNDINGS

Material suitable for use on pool surroundings.

ALREDEDORES PISCINA

Material apto para su uso en inmediaciones de piscinas.

ALENTOURS PISCINES

Matériau qui convient aux abords des piscines.



SHOWER FLOORING

Material suitable for use on shower floors.

PAVIMENTO DUCHAS

Material apto para su uso en suelos de ducha.

REVÊTEMENT DE SOL DOUCHES

Matériau qui convient aux sols de douche.



SHOWER WALL COVERING

Material suitable for use on shower walls.

REVESTIMIENTO DUCHAS

Material apto para su uso en paredes de ducha.

REVÊTEMENT DOUCHES

Matériau qui convient aux murs de douches.

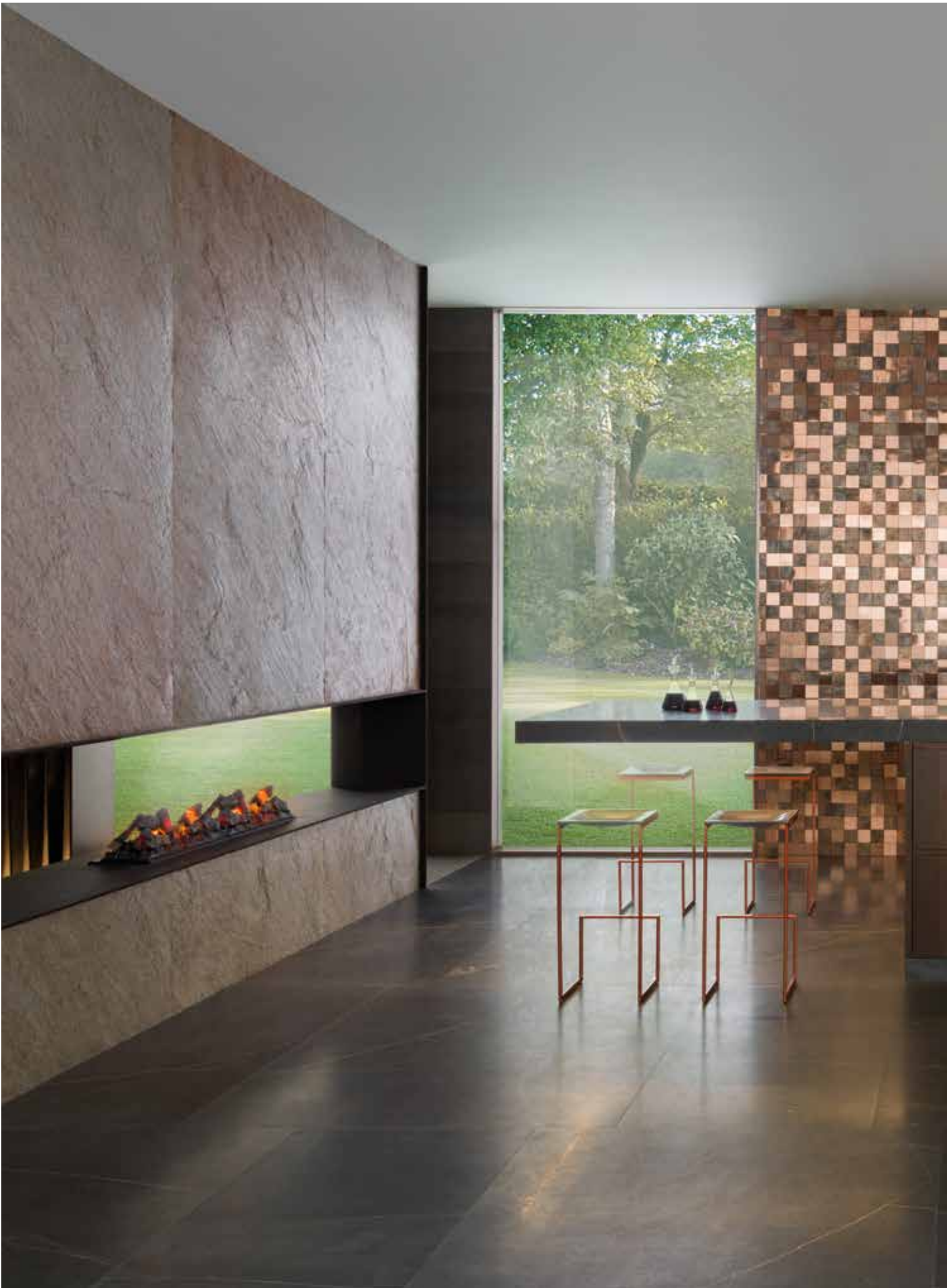

Floor Coverings Habana Dark Classico / Wall Coverings Airslate Bombay, Metal Bronze 3D Cubes

MARBLE MÁRMOL MARBRE



- Blanco Almeria
- Persian White
- Blanco Andes
- Capadocia
- Arctic White
- Kayak Beige
- Nairobi Crema
- Crema Grecia
- Capuccino
- Capuccino Grey
- Habana Brown
- Habana Grey
- Habana Dark

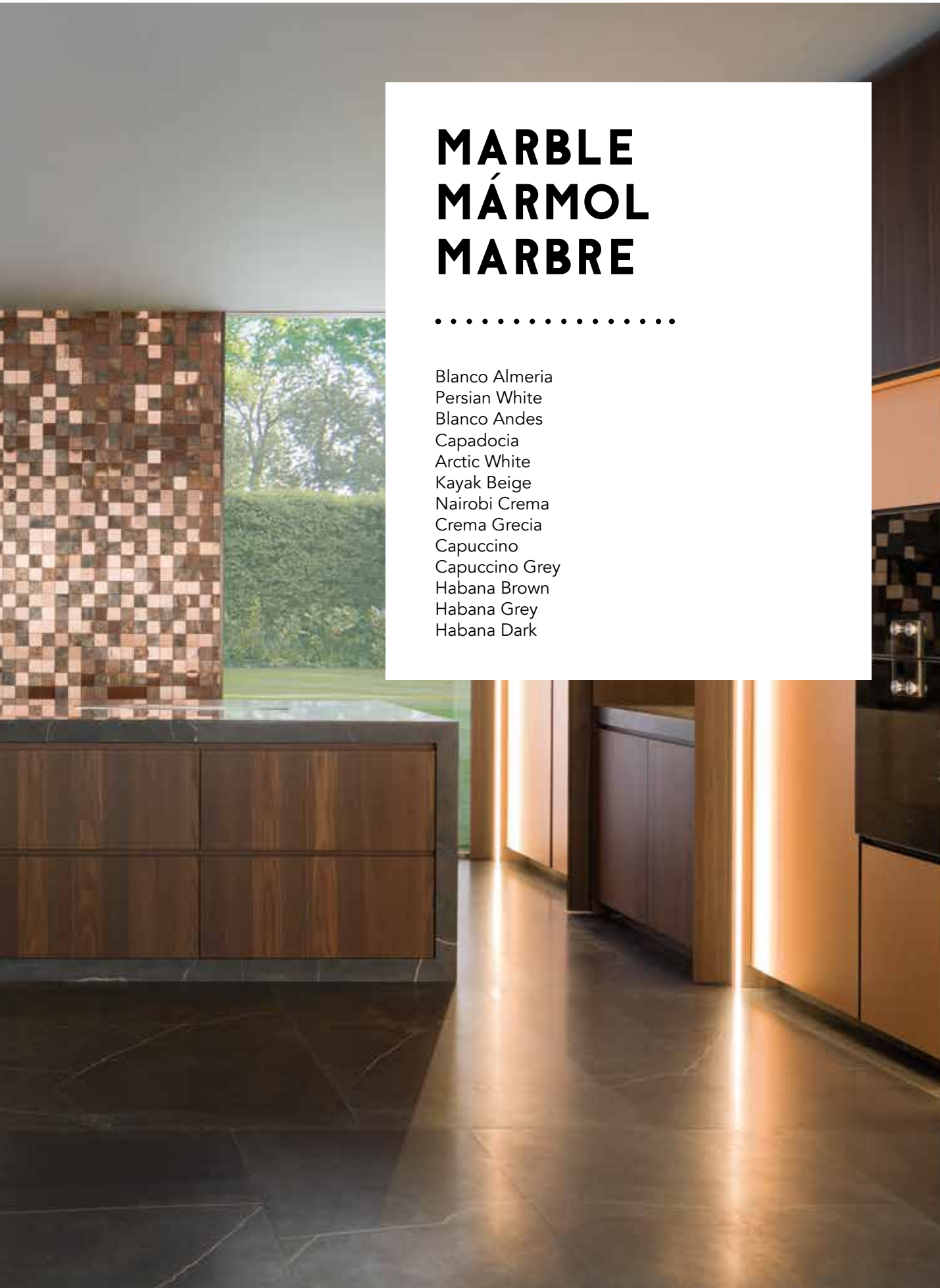

MARBLE / MÁRMOL / MARBRE



Floor Coverings Persian White Pulido

MARBLE / MÁRMOL / MARBRE



Floor Coverings Nairobi Crema Pulido / Wall Coverings Nairobi Crema Pulido, Eternity Mini Strip Cream

MARBLE / MÁRMOL / MARBRE



Blanco Almeria Anticato



Description	Format	Codes	Group	Pcs	m2	Kg
Blanco Almeria Anticato	30x60x1.2 cm 11 3/4"x23 5/8"x1/2"	100000179 L112971001	G-242	4 x Cj 176 x Pal	0,72 x Cj 31,68 x Pal	23.16 x Cj 1019,22 x Pal

Butech: Colorstuk Rapid Blanco



Floor Coverings Capuccino Sand Home / Wall Coverings Blanco Almeria Anticato / Complementary Products Wood Top Nogal Warm, Basic Persian White, Hampton Nogal Warm

MARBLE / MÁRMOL / MARBRE



Persian White Pulido



Description	Format	Codes	Group	Pcs	m2	Kg
Persian White Pulido	9.8x30x1.5 cm 3 7/8"x11 3/4"x5/8"	I00149005 L108027041	G-255	13 x Cj 780 x Pal	0.38 x Cj 22.93 x Pal	16.55 x Cj 992.94 x Pal
Persian White Pulido	30x60x1.5 cm 11 3/4"x23 5/8"x5/8"	I00102697 L119294131	G-255	3 x Cj 132 x Pal	0.54 x Cj 23.76 x Pal	23.39 x Cj 1029.34 x Pal
Persian White Pulido	40x80x2 cm 15 3/4"x31 1/2"x3/4"	I00142942 L108025901	G-263	1 x Cj 78 x Pal	0.32 x Cj 24.96 x Pal	18.48 x Cj 1441.67 x Pal
Persian White Pulido	60x60x2 cm 23 5/8"x23 5/8"x3/4"	I00098384 L100200191	G-263	1 x Cj 40 x Pal	0.36 x Cj 14.40 x Pal	20.80 x Cj 831.80 x Pal
Slab / Tabla / Tranche	2 cm 3/4"	I00155542 L108029771	G-255	-	-	-
Slab / Tabla / Tranche	3 cm 1 1/8"	I00155543 L108029781	G-268	-	-	-

Butech: Colorstuk Rapid Blanco



Persian White Classico



Description	Format	Codes	Group	Pcs	m2	Kg
Persian White Classico	9.8x30x1.5 cm 3 7/8"x11 3/4"x5/8"	I00149004 L108027021	G-255	13 x Cj 780 x Pal	0.38 x Cj 22.93 x Pal	16.18 x Cj 971.10 x Pal
Persian White Classico	30x60x1.5 cm 11 3/4"x23 5/8"x5/8"	I00142837 L112995691	G-255	3 x Cj 132 x Pal	0.54 x Cj 23.76 x Pal	23.39 x Cj 1029.07 x Pal
Persian White Classico	40x80x2 cm 15 3/4"x31 1/2"x3/4"	I00142941 L108025891	G-263	1 x Cj 78 x Pal	0.32 x Cj 24.96 x Pal	18.47 x Cj 1440.66 x Pal
Persian White Classico	60x60x2 cm 23 5/8"x23 5/8"x3/4"	I00142838 L116688241	G-263	1 x Cj 40 x Pal	0.36 x Cj 14.40 x Pal	20.78 x Cj 831.20 x Pal
Slab / Tabla / Tranche	2 cm 3/4"	I00155540 L108029741	G-255	-	-	-
Slab / Tabla / Tranche	3 cm 1 1/8"	I00155541 L108029731	G-268	-	-	-

Butech: Colorstuk Rapid Blanco

MARBLE / MÁRMOL / MARBRE



Blanco Andes Pulido



Description	Format	Codes	Group	Pcs	m2	Kg
Blanco Andes Pulido	30x60x1 cm	100153274	G-263	4 x Cj	0,72 x Cj	10,12 x Cj
	11 3/4"x23 5/8"x3/8"	L119294221		176 x Pal	31,68 x Pal	445,28 x Pal
Blanco Andes Pulido	40x80x1 cm	100153275	G-268	2 x Cj	0,64 x Cj	17,16 x Cj
	15 3/4"x31 1/2"x3/8"	L108028701		156 x Pal	49,92 x Pal	1338,32 x Pal
Blanco Andes Pulido	60x60x1 cm	100153276	G-275	2 x Cj	0,72 x Cj	19,44 x Cj
	23 5/8"x23 5/8"x3/8"	L100200451		92 x Pal	33,12 x Pal	894,24 x Pal
Slab / Tabla / Tranche	2 cm	100153277	G-267	-	-	-
	3/4"	L108028711		-	-	-
Slab / Tabla / Tranche	3 cm	100153278	G-279	-	-	-
	1 1/8"	L108028731		-	-	-

Butech: Colorstuk Rapid Gris



Blanco Andes Classico



Description	Format	Codes	Group	Pcs	m2	Kg
Blanco Andes Classico	30x60x1 cm	100153179	G-263	4 x Cj	0,72 x Cj	10,12 x Cj
	11 3/4"x23 5/8"x3/8"	L112995721		176 x Pal	31,68 x Pal	445,28 x Pal
Blanco Andes Classico	40x80x1 cm	100153270	G-268	2 x Cj	0,64 x Cj	17,16 x Cj
	15 3/4"x31 1/2"x3/8"	L108028681		156 x Pal	49,92 x Pal	1338,32 x Pal
Blanco Andes Classico	60x60x1 cm	100153271	G-275	2 x Cj	0,72 x Cj	19,44 x Cj
	23 5/8"x23 5/8"x3/8"	L116688251		92 x Pal	33,12 x Pal	894,24 x Pal
Slab / Tabla / Tranche	2 cm	100153272	G-267	-	-	-
	3/4"	L108028721		-	-	-
Slab / Tabla / Tranche	3 cm	100153273	G-279	-	-	-
	1 1/8"	L108028691		-	-	-

Butech: Colorstuk Rapid Gris

MARBLE / MÁRMOL / MARBRE

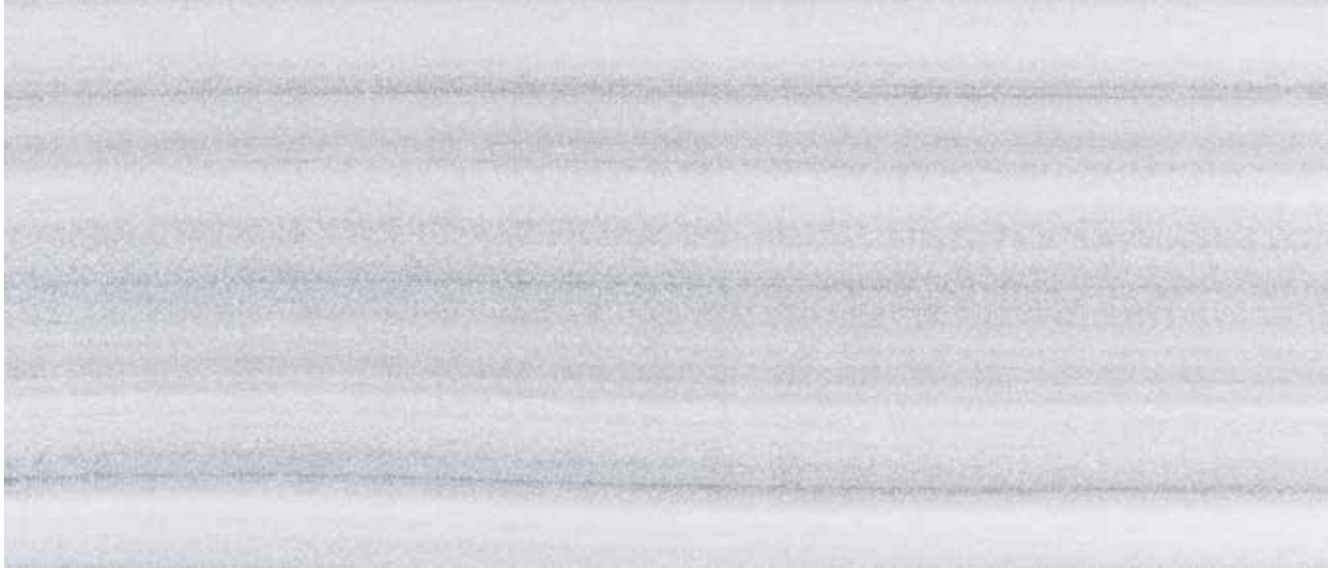

Blanco Andes Sand Home



Description	Format	Codes	Group	Pcs	m2	Kg
Blanco Andes Sand Home	30x60x1 cm	I00161142	G-270	4 x Cj	0,72 x Cj	20,49 x Cj
	11 3/4"x23 5/8"x3/8"	L108032781		176 x Pal	31,68 x Pal	901,64 x Pal
Blanco Andes Sand Home	40x80x1 cm	I00161143	G-276	2 x Cj	0,64 x Cj	18,21 x Cj
	15 3/4"x31 1/2"x3/8"	L108032801		156 x Pal	49,92 x Pal	1420,85 x Pal
Blanco Andes Sand Home	60x60x1 cm	I00161144	G-279	2 x Cj	0,72 x Cj	20,49 x Cj
	23 5/8"x23 5/8"x3/8"	L108032791		92 x Pal	33,12 x Pal	942,63 x Pal

Butech: Colorstuk Rapid Gris



Floor Coverings Blanco Andes Classico, Blanco Andes Sand Home / Wall Coverings Blanco Andes Classico, Harmony Strip Coltan

MARBLE / MÁRMOL / MARBRE



Capadocia Sand Home



Description	Format	Codes	Group	Pcs	m2	Kg
Capadocia Sand Home	30x60x1.2 cm 11 3/4"x23 5/8"x1/2"	100114124 L108020551	G-272	4 x Cj 176 x Pal	0,72 x Cj 31,68 x Pal	25 x Cj 1100,18 x Pal

Butech: Colorstuk Rapid Blanco



Floor Coverings Mini Eden Texture 1L Almond / Wall Coverings Arctic White Pulido / Complementary Products Men(H)ir Espejo S Natural, Men(H)ir Crema Italia Classico, Men(H)ir Mueble S 3C Natural Persoan White, Men(H)ir Bañera Crema Italia-Natural

MARBLE / MÁRMOL / MARBRE



Arctic White Pulido



Description	Format	Codes	Group	Pcs	m2	Kg
Arctic White Pulido	9.8x30x1.5 cm 3 7/8"x11 3/4"x5/8"	I00148978 L108026981	G-257	13 x Cj 780 x Pal	0.38 x Cj 22.93 x Pal	16.95 x Cj 1017.12 x Pal
Arctic White Pulido	30x60x1.5 cm 11 3/4"x23 5/8"x5/8"	I00146821 L119294201	G-257	3 x Cj 132 x Pal	0.54 x Cj 23.76 x Pal	23.10 x Cj 1016.40 x Pal
Arctic White Pulido	40x80x1.5 cm 15 3/4"x31 1/2"x5/8"	I00146008 L108026371	G-260	1 x Cj 78 x Pal	0.32 x Cj 24.96 x Pal	11.32 x Cj 883.04 x Pal
Slab / Tabla / Tranche	2 cm 3/4"	I00155457 L108029471	G-255	- -	- -	- -
Slab / Tabla / Tranche	3 cm 1 1/8"	I00155458 L108029521	G-268	- -	- -	- -

Butech: Colorstuk Rapid Blanco



Arctic White Classico



Description	Format	Codes	Group	Pcs	m2	Kg
Arctic White Classico	9.8x30x1.5 cm 3 7/8"x11 3/4"x5/8"	I00149011 L108027081	G-257	13 x Cj 780 x Pal	0.38 x Cj 22.93 x Pal	16.95 x Cj 1017.12 x Pal
Arctic White Classico	30x60x1.5 cm 11 3/4"x23 5/8"x5/8"	I00168106 L112995791	G-257	3 x Cj 132 x Pal	0.54 x Cj 23.76 x Pal	23.96 x Cj 1054.28 x Pal
Arctic White Classico	40x80x1.5 cm 15 3/4"x31 1/2"x5/8"	I00168185 L108035271	G-260	1 x Cj 78 x Pal	0.32 x Cj 24.96 x Pal	14.20 x Cj 1107.60 x Pal
Slab / Tabla / Tranche	2 cm 3/4"	I00168194 L108035281	G-244	- -	- -	- -
Slab / Tabla / Tranche	3 cm 1 1/8"	I00168205 L108035301	G-257	- -	- -	- -

Butech: Colorstuk Rapid Blanco

MARBLE / MÁRMOL / MARBRE



Kayak Beige Pulido



Description	Format	Codes	Group	Pcs	m2	Kg
Kayak Beige Pulido	30x60x1 cm	100156153	G-267	4 x Cj	0,72 x Cj	17,63 x Cj
	11 3/4"x23 5/8"x3/8"	L119294241		176 x Pal	31,68 x Pal	775,98 x Pal
Kayak Beige Pulido	40x80x1 cm	100156154	G-270	1 x Cj	0,32 x Cj	8,94 x Cj
	15 3/4"x31 1/2"x3/8"	L108029991		78 x Pal	24,96 x Pal	697,47 x Pal
Kayak Beige Pulido	60x60x1 cm	100156155	G-275	2 x Cj	0,72 x Cj	20,12 x Cj
	23 5/8"x23 5/8"x3/8"	L100200481		92 x Pal	33,12 x Pal	925,52 x Pal
Slab / Tabla / Tranche	2 cm	100156156	G-279	-	-	-
	3/4"	L108029981		-	-	-
Slab / Tabla / Tranche	3 cm	100156157	G-282	-	-	-
	1 1/8"	L108029971		-	-	-

Butech: Colorstuk Rapid Marfil



Kayak Beige Classico



Description	Format	Codes	Group	Pcs	m2	Kg
Kayak Beige Classico	30x60x1 cm	100161161	G-267	4 x Cj	0,72 x Cj	18,97 x Cj
	11 3/4"x23 5/8"x3/8"	L112995781		176 x Pal	31,68 x Pal	834,94 x Pal
Kayak Beige Classico	40x80x1 cm	100161170	G-270	2 x Cj	0,64 x Cj	16,86 x Cj
	15 3/4"x31 1/2"x3/8"	L108032831		156 x Pal	49,92 x Pal	1315,70 x Pal
Kayak Beige Classico	60x60x1 cm	100173382	G-275	2 x Cj	0,72 x Cj	18,97 x Cj
	23 5/8"x23 5/8"x3/8"	L116688361		92 x Pal	33,12 x Pal	872,89 x Pal
Slab / Tabla / Tranche	2 cm	100161179	G-279	-	-	-
	3/4"	L108032761		-	-	-
Slab / Tabla / Tranche	3 cm	100161084	G-282	-	-	-
	1 1/8"	L108032711		-	-	-

Butech: Colorstuk Rapid Marfil

MARBLE / MÁRMOL / MARBRE



Nairobi Crema Pulido



Description	Format	Codes	Group	Pcs	m2	Kg
Nairobi Crema Pulido	30x60x1,2 cm 11 3/4"x23 5/8"x1/2"	100045556 L100300071	G-260	4 x Cj 132 x Pal	0,72 x Cj 31,68 x Pal	24,22 x Cj 1065,68 x Pal
Nairobi Crema Pulido	40x80x1,5 cm 15 3/4"x31 1/2"x5/8"	100073337 L108006921	G-267	1 x Cj 78 x Pal	0,32 x Cj 24,96 x Pal	11,50 x Cj 897 x Pal
Nairobi Crema Pulido	60x60x1,5 cm 23 5/8"x23 5/8"x5/8"	100045557 L100300081	G-267	1 x Cj 40 x Pal	0,36 x Cj 14,40 x Pal	15,71 x Cj 628,52 x Pal
Slab / Tabla / Tranche	2 cm 3/4"	100155508 L108029701	G-265	-	-	-
Slab / Tabla / Tranche	3 cm 1 1/8"	100155509 L108029721	G-272	-	-	-



Butech: Colorstuk Rapid Marfil



Nairobi Crema Classico



Description	Format	Codes	Group	Pcs	m2	Kg
Nairobi Crema Classico	30x60x1,2 cm 11 3/4"x23 5/8"x1/2"	100089719 L112995351	G-260	4 x Cj 176 x Pal	0,72 x Cj 31,68 x Pal	24,22 x Cj 1065,68 x Pal
Nairobi Crema Classico	40x80x1,5 cm 15 3/4"x31 1/2"x5/8"	100089720 L108011571	G-267	1 x Cj 78 x Pal	0,32 x Cj 24,96 x Pal	13,20 x Cj 1029,6 x Pal
Nairobi Crema Classico	60x60x1,5 cm 23 5/8"x23 5/8"x5/8"	100098366 L116688121	G-267	1 x Cj 40 x Pal	0,36 x Cj 14,40 x Pal	14,72 x Cj 588,92 x Pal
Slab / Tabla / Tranche	2 cm 3/4"	100155506 L108029711	G-265	-	-	-
Slab / Tabla / Tranche	3 cm 1 1/8"	100155507 L108029761	G-272	-	-	-

Butech: Colorstuk Rapid Marfil

MARBLE / MÁRMOL / MARBRE



Crema Grecia Anticato



Description	Format	Codes	Group	Pcs	m2	Kg
Crema Grecia Anticato	30x60x1.2 cm	100000184	G-252	4 x Cj	0,72 x Cj	25 x Cj
	11 3/4"x23 5/8"x1/2"	L112982001		176 x Pal	31,68 x Pal	1100,18 x Pal



Butech: Colorstuk Rapid Beige



Crema Grecia Classico



Description	Format	Codes	Group	Pcs	m2	Kg
Crema Grecia Classico	30x60x1.2 cm	100000188	G-267	4 x Cj	0,72 x Cj	24 x Cj
	11 3/4"x23 5/8"x1/2"	L112992001		176 x Pal	31,68 x Pal	1056 x Pal
Crema Grecia Classico	40x80x1.5 cm	100082211	G-275	1 x Cj	0,32 x Cj	11,50 x Cj
	15 3/4"x31 1/2"x5/8"	L108008941		78 x Pal	24,96 x Pal	897 x Pal
Crema Grecia Classico	60x60x2 cm	100003812	G-276	1 x Cj	0,36 x Cj	20 x Cj
	23 5/8"x23 5/8"x3/4"	L113098021		40 x Pal	14,40 x Pal	800 x Pal
Slab / Tabla / Tranche	2 cm	100155525	G-276	-	-	-
	3/4"	L108029541		-	-	-
Slab / Tabla / Tranche	3 cm	100155526	G-283	-	-	-
	1 1/8"	L108029511		-	-	-



Butech: Colorstuk Rapid Beige

MARBLE / MÁRMOL / MARBRE



Crema Grecia Pulido



Description	Format	Codes	Group	Pcs	m2	Kg
Crema Grecia Pulido	30x60x1,2 cm	100179149	G-267	4 x Cj	0,72 x Cj	23,51 x Cj
	11 3/4"x23 5/8"x1/2"	L119294301		176 x Pal	31,68 x Pal	1034,35 x Pal
Crema Grecia Pulido	40x80x1,5 cm	100179165	G-275	1 x Cj	0,32 x Cj	13,06 x Cj
	15 3/4"x31 1/2"x5/8"	L108038331		78 x Pal	24,96 x Pal	1018,60 x Pal
Crema Grecia Pulido	60x60x2 cm	100179175	G-276	1 x Cj	0,36 x Cj	19,59 x Cj
	23 5/8"x23 5/8"x3/4"	L100200621		40 x Pal	14,4 x Pal	783,56 x Pal
Tabla Crema Grecia Pulido	2 cm	100179366	G-276	-	-	-
	3/4"	L108038491		-	-	-
Tabla Crema Grecia Pulido	3 cm	100179356	G-283	-	-	-
	1 1/8"	L108038501		-	-	-

Butech: Colorstuk Rapid Beige



Floor Coverings Crema Grecia Classico

MARBLE / MÁRMOL / MARBRE



Capuccino Pulido



Description	Format	Codes	Group	Pcs	m2	Kg
Capuccino Pulido	30x60x1.2 cm	100000160	G-252	4 x Cj	0,72 x Cj	24,09 x Cj
	11 3/4"x23 5/8"x1/2"	L112925161		176 x Pal	31,68 x Pal	1060,05 x Pal
Capuccino Pulido	60x60x2 cm	100000462	G-265	1 x Cj	0,36 x Cj	21,34 x Cj
	23 5/8"x23 5/8"x3/4"	L116686001		40 x Pal	14,40 x Pal	853,52 x Pal
Slab / Tabla / Tranche	2 cm	100155523	G-268	-	-	-
	3/4"	L108029481		-	-	-
Slab / Tabla / Tranche	3 cm	100155524	G-279	-	-	-
	1 1/8"	L108029551		-	-	-

Butech: Colorstuk Rapid Beige



Capuccino Sand Home



Description	Format	Codes	Group	Pcs	m2	Kg
Capuccino Sand Home	30x60x1.5 cm	100114602	G-268	3 x Cj	0,54 x Cj	17,82 x Cj
	11 3/4"x23 5/8"x5/8"	L108020741		132 x Pal	23,76 x Pal	784,08 x Pal
Capuccino Sand Home	40x80x1.5 cm	100096778	G-270	1 x Cj	0,32 x Cj	13,22 x Cj
	15 3/4"x31 1/2"x5/8"	L108015071		78 x Pal	24,96 x Pal	1031 x Pal

Butech: Colorstuk Rapid Beige

MARBLE / MÁRMOL / MARBRE



Capuccino Grey Pulido



Description	Format	Codes	Group	Pcs	m2	Kg
Capuccino Grey Pulido	30x60x1.5 cm 11 3/4"x23 5/8"x5/8"	100161181 L119294261	G-268	3 x Cj 132 x Pal	0,54 x Cj 23,76 x Pal	15,21 x Cj 669,50 x Pal
Capuccino Grey Pulido	40x80x1.5 cm 15 3/4"x31 1/2"x5/8"	100161149 L108032821	G-275	1 x Cj 78 x Pal	0,32 x Cj 24,96 x Pal	9,01 x Cj 703,32 x Pal
Capuccino Grey Pulido	60x60x1.5 cm 23 5/8"x23 5/8"x5/8"	100161160 L100200541	G-276	1 x Cj 40 x Pal	0,36 x Cj 14,4 x Pal	10,14 x Pal 405,80 x Cj
Slab / Tabla / Tranche	2 cm 3/4"	100161177 L108032771	G-268	- -	- -	- -
Slab / Tabla / Tranche	3 cm 1 1/8"	100161178 L108032751	G-279	- -	- -	- -

Butech: Colorstuk Rapid Cemento



Capuccino Grey Classico



Description	Format	Codes	Group	Pcs	m2	Kg
Capuccino Grey Classico	30x60x1.5 cm 11 3/4"x23 5/8"x5/8"	100161180 L112995771	G-268	3 x Cj 132 x Pal	0,54 x Cj 23,76 x Pal	15,21 x Cj 669,50 x Pal
Capuccino Grey Classico	40x80x1.5 cm 15 3/4"x31 1/2"x5/8"	100161146 L108032811	G-275	1 x Cj 78 x Pal	0,32 x Cj 24,96 x Pal	9,01 x Cj 703,32 x Pal
Capuccino Grey Classico	60x60x1.5 cm 23 5/8"x23 5/8"x5/8"	100161147 L116688291	G-276	1 x Cj 40 x Pal	0,36 x Cj 14,4 x Pal	10,14 x Pal 405,80 x Cj
Slab / Tabla / Tranche	2 cm 3/4"	100161175 L108032731	G-268	- -	- -	- -
Slab / Tabla / Tranche	3 cm 1 1/8"	100161176 L108032741	G-279	- -	- -	- -

Butech: Colorstuk Rapid Cemento

MARBLE / MÁRMOL / MARBRE



Habana Brown Pulido



Description	Format	Codes	Group	Pcs	m2	Kg
Habana Brown Pulido	30x60x1.2 cm	10001541	G-257	4 x Cj	0.72 x Cj	24.84 x Cj
	11 3/4"x23 5/8"x1/2"	L150501001		176 x Pal	31.68 x Pal	1092.96 x Pal
Habana Brown Pulido	40x80x1.5 cm	100073336	G-270	1 x Cj	0.32 x Cj	13.64 x Cj
	15 3/4"x31 1/2"x5/8"	L108006911		78 x Pal	24.96 x Pal	1064 x Pal
Slab / Tabla / Tranche	2 cm	100155533	G-272	-	-	-
	3/4"	L108029571		-	-	-
Slab / Tabla / Tranche	3 cm	100155534	G-279	-	-	-
	1 1/8"	L108029661		-	-	-

Butech: Colorstuk Rapid Antracita



Habana Brown Classico



Description	Format	Codes	Group	Pcs	m2	Kg
Habana Brown Classico	30x60x1.2 cm	100092925	G-257	4 x Cj	0.72 x Cj	24.84 x Cj
	11 3/4"x23 5/8"x1/2"	L112995361		176 x Pal	31.68 x Pal	1092.96 x Pal
Habana Brown Classico	40x80x1.5 cm	100092715	G-270	1 x Cj	0.32 x Cj	13.06
	15 3/4"x31 1/2"x5/8"	L108012931		78 x Pal	24.96 x Pal	1019 x Pal
Slab / Tabla / Tranche	2 cm	100155531	G-272	-	-	-
	3/4"	L108029611		-	-	-
Slab / Tabla / Tranche	3 cm	100155532	G-279	-	-	-
	1 1/8"	L108029591		-	-	-

Butech: Colorstuk Rapid Antracita

MARBLE / MÁRMOL / MARBRE



Habana Brown Sand Home



Description	Format	Codes	Group	Pcs	m2	Kg
Habana Brown Sand Home	30x60x1.5 cm 11 3/4"x23 5/8"x5/8"	100115881 L108021111	G-272	3 x Cj 132 x Pal	0,54 x Cj 23,76 x Pal	23,29 x Cj 1024,58 x Pal
Habana Brown Sand Home	40x80x1.5 cm 15 3/4"x31 1/2"x5/8"	100096784 L108015081	G-275	1 x Cj 78 x Pal	0,32 x Cj 24,96 x Pal	13,44 x Cj 1048 x Pal

Butech: Colorstuk Rapid Manhattan



Floor Coverings Kayak Beige Pulido / Wall Coverings Habana Brown Pulido / Complementary Products Lavabo Krabi Persian White, W-Tower Roble Clody

MARBLE / MÁRMOL / MARBRE



Habana Grey Pulido



Description	Format	Codes	Group	Pcs	m2	Kg
Habana Grey Pulido	30x60x1,2 cm	100168313	G-260	4 x Cj	0,72 x Cj	23,18 x Cj
	11 3/4"x23 5/8"x1/2"	L119294271		176 x Pal	31,68 x Pal	1019,92 x Pal
Habana Grey Pulido	40x80x1,5 cm	100168309	G-268	1 x Cj	0,32 x Cj	13,06 x Cj
	15 3/4"x31 1/2"x5/8"	L108035361		78 x Pal	24,96 x Pal	1018,99 x Pal
Slab / Tabla / Tranche	2 cm	100176336	G-272	-	-	-
	3/4"	L108037361		-	-	-
Slab / Tabla / Tranche	3 cm	100176327	G-279	-	-	-
	1 1/8"	L108037371		-	-	-

Butech: Colorstuk Rapid Cemento



Habana Grey Classico



Description	Format	Codes	Group	Pcs	m2	Kg
Habana Grey Classico	30x60x1,2 cm	100168312	G-260	4 x Cj	0,72 x Cj	23,18 x Cj
	11 3/4"x23 5/8"x1/2"	L112995841		176 x Pal	31,68 x Pal	1019,92 x Pal
Habana Grey Classico	40x80x1,5 cm	100168308	G-268	1 x Cj	0,32 x Cj	13,06 x Cj
	15 3/4"x31 1/2"x5/8"	L108035351		78 x Pal	24,96 x Pal	1018,99 x Pal
Slab / Tabla / Tranche	2 cm	100176351	G-272	-	-	-
	3/4"	L108037341		-	-	-
Slab / Tabla / Tranche	3 cm	100176347	G-279	-	-	-
	1 1/8"	L108037351		-	-	-

Butech: Colorstuk Rapid Cemento

MARBLE / MÁRMOL / MARBRE



Habana Dark Pulido



Description	Format	Codes	Group	Pcs	m2	Kg
Habana Dark Pulido	30x60x1.5 cm 11 3/4"x23 5/8"x5/8"	I00086382 L119294091	G-270	3 x Cj 132 x Pal	0,54 x Cj 23,76 x Pal	21,89 x Cj 963,20 x Pal
Habana Dark Pulido	40x80x1.5 cm 15 3/4"x31 1/2"x5/8"	I00086383 L108010481	G-275	1 x Cj 78 x Pal	0,32 x Cj 24,96 x Pal	13,79 x Cj 1076 x Pal
Habana Dark Pulido	60x60x1.5 cm 23 5/8"x23 5/8"x5/8"	I00177669 L100200611	G-276	1 x Cj 40 x Pal	0,36 x Cj 14,40 x Pal	19,46 x Cj 778,32 x Pal
Slab / Tabla / Tranche	2 cm 3/4"	I00155502 L108029671	G-272	- -	- -	- -
Slab / Tabla / Tranche	3 cm 1 1/8"	I00155503 L108029691	G-282	- -	- -	- -

Butech: Colorstuk Rapid Antracita



Habana Dark Classico



Description	Format	Codes	Group	Pcs	m2	Kg
Habana Dark Classico	30x60x1.5 cm 11 3/4"x23 5/8"x5/8"	I00171865 L112996261	G-270	3 x Cj 132 x Pal	0,54 x Cj 23,76 x Pal	21,89 x Cj 963,20 x Pal
Habana Dark Classico	40x80x1.5 cm 15 3/4"x31 1/2"x5/8"	I00171866 L108036571	G-275	1 x Cj 78 x Pal	0,32 x Cj 24,96 x Pal	13,79 x Cj 1076 x Pal
Habana Dark Classico	60x60x1.5 cm 23 5/8"x23 5/8"x5/8"	I00177693 L116688381	G-276	1 x Cj 40 x Pal	0,36 x Cj 14,40 x Pal	19,46 x Cj 778,32 x Pal
Slab / Tabla / Tranche	2 cm 3/4"	I00155535 L108029631	G-272	- -	- -	- -
Slab / Tabla / Tranche	3 cm 1 1/8"	I00155536 L108029581	G-282	- -	- -	- -

Butech: Colorstuk Rapid Antracita





Floor Coverings Silver Wood Classico / Wall Coverings Silver Wood Classico / Complementary Products Men(H)ir Crema Italia Classico, Men(H)ir Encimera L Roble Antracita, Men(H)ir Mueble L Crema Italia-Roble Antracita, Men(H)ir Espejo Roble Antracita, Men(H)ir Estante Vertical I Roble Antracita.

TRAVERTINE TRAVERTINO TRAVERTIN

.....

Moka
Toscano
Silver Wood
Silk Wood



TRAVERTINE / TRAVERTINO / TRAVERTIN



Moka Anticato



Description	Format	Codes	Group	Pcs	m2	Kg
Moka Anticato	30x60x1.2 cm 11 3/4"x23 5/8"x1/2"	100000183 L112981001	G-246	4 x Cj 176 x Pal	0.72 x Cj 31.68 x Pal	23.16 x Cj 1019.22 x Pal

Butech: Colorstuk Rapid Beige



Moka Classico



Description	Format	Codes	Group	Pcs	m2	Kg
Moka Classico	30x60x1.2 cm 11 3/4"x23 5/8"x1/2"	100000187 L112991001	G-257	4 x Cj 176 x Pal	0.72 x Cj 31.68 x Pal	21.03 x Cj 925.41 x Pal
Moka Classico	40x80x1.5 cm 15 3/4"x31 1/2"x5/8"	100073340 L108006961	G-268	1 x Cj 78 x Pal	0.32 x Cj 24.96 x Pal	12.65 x Cj 997 x Pal
Moka Classico	60x60x2 cm 23 5/8"x23 5/8"x3/4"	100000456 L116661501	G-275	1 x Cj 40 x Pal	0.36 x Cj 14.40 x Pal	17.87 x Cj 714.84 x Pal
Slab / Tabla / Tranche	2 cm 3/4"	100155504 L108029751	G-270	-	-	-
Slab / Tabla / Tranche	3 cm 1 1/8"	100155505 L108029681	G-279	-	-	-

Butech: Colorstuk Rapid Marfil

TRAVERTINE / TRAVERTINO / TRAVERTIN

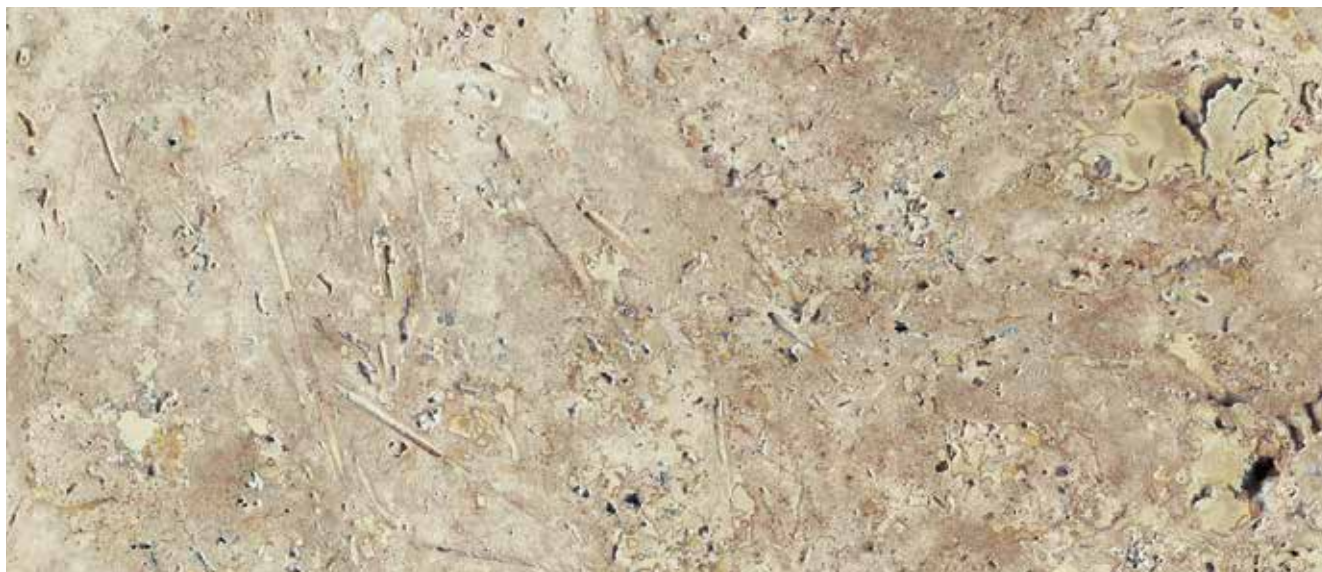

Toscano Anticato



Description	Format	Codes	Group	Pcs	m2	Kg
Toscano Anticato	Multiformat / Multiformato / Multiformat	100107322 L107600221	G-242	1 x Cj 23 x Pal	0,72 x Cj 16,56 x Pal	23,57 x Cj 542,20 x Pal

Butech: Colorstuk Rapid Beige

MULTIFORMAT / MULTIFORMATO / MULTIFORMAT

Packet is served. 0,72 m2 per pack, composed of 40,6x40,6x1,2 (2pzs.), 20x20x1,2 (2pzs.), 40,6x61,2x1,2 (1pzs.), 20x40,6x1,2 (1pzs.) / Se sirve por paquetes. 0,72 m² por paquete, compuesto por 40,6x40,6x1,2 (2pzs.), 20x20x1,2 (2pzs.), 40,6x61,2x1,2 (1pzs.), 20x40,6x1,2 (1pzs.) / Paquet est servi. 0,72 m2 par paquet, composé de 40,6x40,6x1,2 (2pzs.), 20x20x1,2 (2pzs.), 40,6x61,2x1,2 (1pzs.), 20x40,6x1,2 (1pzs.)

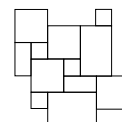

SUGGESTED LAYOUT
EJEMPLO COLOCACIÓN
EXEMPLE DE POSE



Floor Coverings Multiformato Toscano Anticato

TRAVERTINE / TRAVERTINO / TRAVERTIN



Silver Wood Classico

- BIOPROT
- MATT
- MODERATE COLOR VARIATION
- BEVEL
- ORIGIN ASIA
- INDOOR FLOORING
- INDOOR WALL COVERING
- OUTDOOR WALL COVERING
- SHOWER WALL COVERINGS
- COUNTERTOPS
- LOW TRAFFIC
- RAMP CLASSIFICATION

Description	Format	Codes	Group	Pcs	m2	Kg
Silver Wood Classico	7,5x30x1,2 cm 3"x11 3/4"x1/2"	100116171 L108021211	G-279	24 x Cj 2040 x Pal	0,54 x Cj 45,90 x Pal	17,97 x Cj 1527,96 x Pal
Silver Wood Classico	10x60x1,2 cm 3 7/8"x23 5/8"x1/2"	100116170 L108021221	G-279	8 x Cj 480 x Pal	0,48 x Cj 28,80 x Pal	15,69 x Cj 941,76 x Pal
Silver Wood Classico	30x60x1,2 cm 11 3/4"x23 5/8"x1/2"	100110502 L112995631	G-260	4 x Cj 176 x Pal	0,73 x Cj 32 x Pal	22,48 x Cj 989,12 x Pal
Silver Wood Classico	40x80x1,5 cm 15 3/4"x31 1/2"x5/8"	100114132 L108020501	G-265	1 x Cj 78 x Pal	0,32 x Cj 24,96 x Pal	12,93 x Cj 1008,15 x Pal

Butech: Colorstuk Rapid Gris



Floor Coverings Silk Wood Classico / Wall Coverings Silver Wood Classico, Aichi Mix Wood

TRAVERTINE / TRAVERTINO / TRAVERTIN



Silk Wood Classico



Description	Format	Codes	Group	Pcs	m2	Kg
Silk Wood Classico	30x60x1,2 cm	I00120899	G-270	4 x Cj	0,72 x Cj	23,66 x Cj
	11 3/4"x23 5/8"x1/2"	L112995651		176 x Pal	31,68 x Pal	1041,22 x Pal
Silk Wood Classico	40x80x1,5 cm	I00120900	G-276	1 x Cj	0,32 x Cj	12,91 x Cj
	15 3/4"x31 1/2"x5/8"	L108021961		78 x Pal	24,96 x Pal	1007,45 x Pal

Butech: Colorstuk Rapid Gris



Floor Coverings Silk Wood Classico / Wall Coverings Silver Wood Classico, Aichi Mix Wood



Floor Coverings Linkfloor Oak Grey / Wall Coverings Chennai White Flamed Home, Tecno Linear Silver White / Complementary Products Men{H}ir Habana Dark Classico, Men{H}ir Encimera L Nogal Americano, Men{H}ir Mueble L Habana Dark / Nogal Americano

QUARTZITE CUARCITA QUARTZITE

.....

Chennai White
Lagos Black
Sherpa Brown



QUARTZITE / CUARCITA / QUARTZITE



Chennai White Flamed Home



Description	Format	Codes	Group	Pcs	m2	Kg
Chennai White Flamed Home	30x60x1.5 cm 11 3/4"x23 5/8"x5/8"	100162737 L107601281	G-240	3 x Cj 132 x Pal	0,54 x Cj 23,76 x Pal	24,18 x Cj 1063,92 x Pal
Chennai White Flamed Home	40x80x1.5 cm 15 3/4"x31 1/2"x5/8"	100086252 L107000151	G-246	1 x Cj 78 x Pal	0,32 x Cj 24,96 x Pal	14,33 x Cj 1117,82 x Pal

Butech: Colorstuk Rapid Gris



Wall Coverings Chennai White Flamed Home / Complementary Products Geisha Crema Italia Classico, Khoa Crema Italia Classico

QUARTZITE / CUARCITA / QUARTZITE



Lagos Black Home



Description	Format	Codes	Group	Pcs	m2	Kg
Lagos Black Home	30x60x1.5 cm 11 3/4"x23 5/8"x5/8"	I00120894 L107600251	G-246	3 x Cj 132 x Pal	0,54 x Cj 23,76 x Pal	41,74 x Cj 1836,78 x Pal
Lagos Black Home	40x80x1.5 cm 15 3/4"x31 1/2"x5/8"	I00120895 L107600241	G-249	1 x Cj 78 x Pal	0,32 x Cj 24,96 x Pal	13,91 x Cj 1085,37 x Pal

Butech: Colorstuk Rapid Negro



Wall Coverings Lagos Black Home

QUARTZITE / CUARCITA / QUARTZITE



Sherpa Brown Home



Description	Format	Codes	Group	Pcs	m2	Kg
Sherpa Brown Home	30x60x1.5 cm 11 3/4"x23 5/8"x5/8"	100081826 L112995131	G-255	3 x Cj 132 x Pal	0,54 x Cj 23,76 x Pal	23,51 x Cj 1034,48 x Pal
Sherpa Brown Home	40x80x1.5 cm 15 3/4"x31 1/2"x5/8"	100073338 L106200121	G-260	1 x Cj 78 x Pal	0,32 x Cj 24,96 x Pal	13,93 x Cj 1086,85 x Pal
Sherpa Brown Home	60x60x1.5 cm 23 5/8"x23 5/8"x5/8"	100098379 L107000571	G-260	1 x Cj 40 x Pal	0,36 x Cj 14,40 x Pal	15,53 x Cj 621 x Pal
Slab / Tabla / Tranche	2 cm 3/4"	100155574 L107601051	G-265	-	-	-

Butech: Colorstuk Rapid Antracita



Wall Coverings Sherpa Brown Home

QUARTZITE / CUARCITA / QUARTZITE



Floor Coverings Calgary Classico / Wall Coverings Sherpa Brown Home

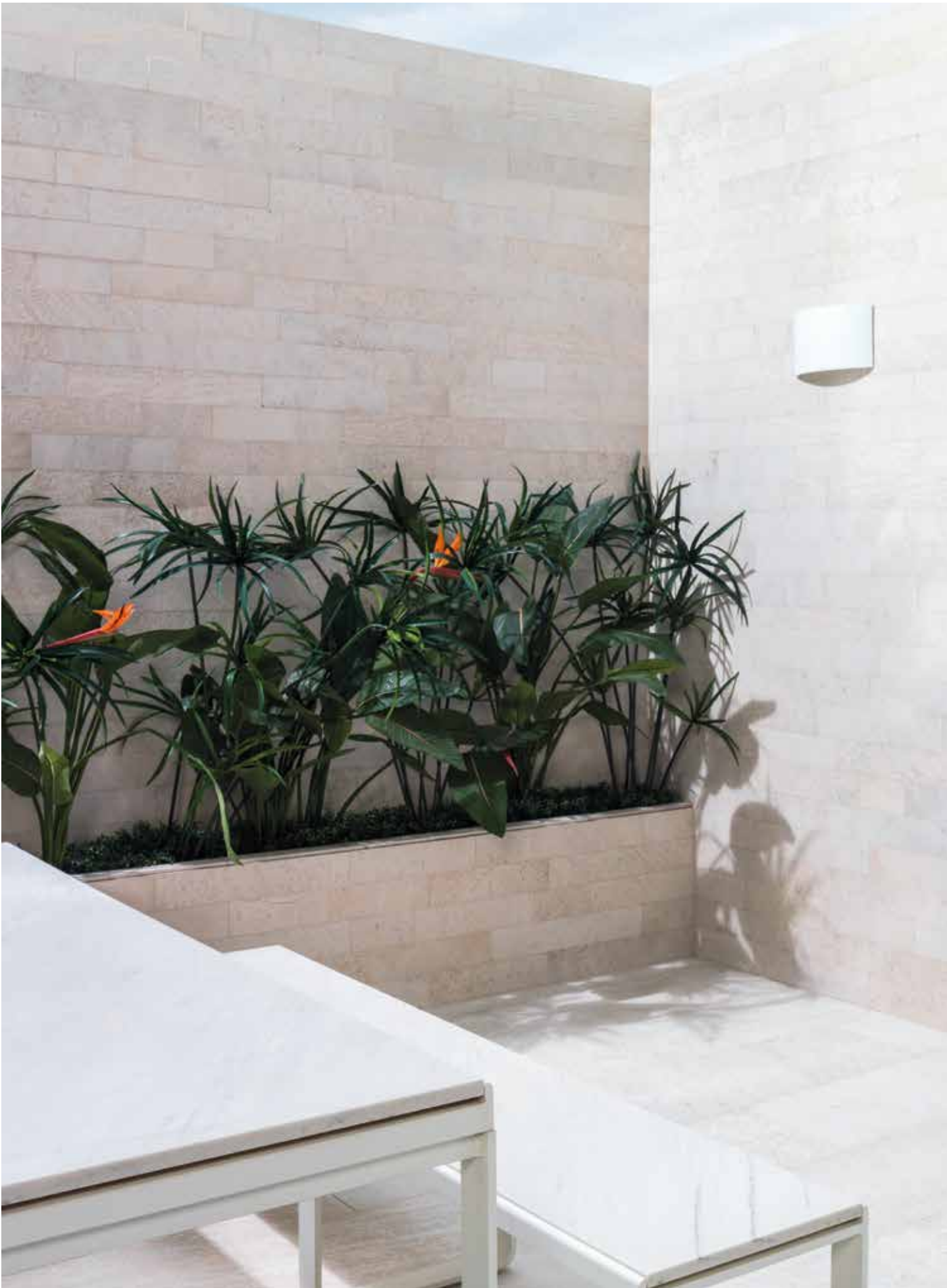

Floor Coverings Amsterdam Beige / Wall Coverings Amsterdam Wall Beige

LIMESTONE CALIZA PIERRE CALCAIRE

.....

Calgary
Montreal
Sahara
Cream Aged
Vancouver
Ottawa
Amsterdam Grey
Amsterdam Beige



LIMESTONE / CALIZA / PIERRE CALCAIRE



Calgary Classico



Description	Format	Codes	Group	Pcs	m2	Kg
Calgary Classico	30x60x1.2 cm	100098313	G-242	4 x Cj	0.72 x Cj	23.18 x Cj
	11 3/4"x23 5/8"x1/2"	L112995511		176 x Pal	31.68 x Pal	1020.10 x Pal
Calgary Classico	40x80x1.5 cm	100188256	G-249	1 x Cj	0.31 x Cj	12.15 x Cj
	15 3/4"x31 1/2"x5/8"	L105004281		78 x Pal	24.18 x Pal	948.01 x Cj
Calgary Classico	60x60x1.5 cm	100098317	G-249	1 x Cj	0.36 x Cj	14.39 x Cj
	23 5/8"x23 5/8"x5/8"	L105000561		40 x Pal	14.40 x Pal	575.48 x Pal
Slab / Tabla / Tranche	2 cm	100155518	G-257	-	-	-
	3/4"	L105002501		-	-	-
Slab / Tabla / Tranche	3 cm	100155519	G-267	-	-	-
	1 1/8"	L105002471		-	-	-

Butech: Colorstuk Rapid Marfil



Floor Coverings Calgary Classico / Wall Coverings Sherpa Brown Home

LIMESTONE / CALIZA / PIERRE CALCAIRE



Montreal Classico



Description	Format	Codes	Group	Pcs	m2	Kg
Montreal Classico	30x60x1,5 cm 11 3/4"x23 5/8"x5/8"	I00161172 L108032721	G-257	3 x Cj 132 x Pal	0,54 x Cj 23,76 x Pal	22,69 x Cj 998,71 x Pal
Montreal Classico	40x80x1,5 cm 15 3/4"x31 1/2"x5/8"	I00161173 L105002651	G-265	1 x Cj 78 x Pal	0,32 x Cj 24,96 x Pal	13,45 x Cj 1049,10 x Pal
Montreal Classico	60x60x1,5 cm 23 5/8"x23 5/8"x5/8"	I00161088 L108032841	G-265	1 x Cj 40 x Pal	0,36 x Cj 14,40 x Pal	15,13 x Cj 605,24 x Pal
Slab / Tabla / Tranche	2 cm 3/4"	I00161085 L105002631	G-252	- -	- -	- -
Slab / Tabla / Tranche	3 cm 1 1/8"	I00161086 L105002641	G-260	- -	- -	- -

Butech: Colorstuk Rapid Beige



Floor Coverings Montreal Classico / Wall Coverings Montreal Classico, Wood Square Aged

LIMESTONE / CALIZA / PIERRE CALCAIRE



Sahara Anticato



Description	Format	Codes	Group	Pcs	m2	Kg
Sahara Anticato	Multiformato Multiformat	I00107321 L105001821	G-252	1 x Cj 23 x Pal	0,72 x Cj 16,56 x Pal	24,18 x Cj 556,16 x Pal

Butech: Colorstuk Rapid Bahama

MULTIFORMAT / MULTIFORMATO / MULTIFORMAT

Packet is served 0,72 m2 per pack, composed of 40,6x40,6x1,2 (2pzs.), 20x20x1,2 (2pzs.), 40,6x61,2x1,2 (1pzs.), 20x40,6x1,2 (1pzs.) / Se sirve por paquetes, 0,72 m² por paquete, compuesto por 40,6x40,6x1,2 (2pzs.), 20x20x1,2 (2pzs.), 40,6x61,2x1,2 (1pzs.), 20x40,6x1,2 (1pzs.) / Paquet est servi, 0,72 m2 par paquet, composé de 40,6x40,6x1,2 (2pzs.), 20x20x1,2 (2pzs.), 40,6x61,2x1,2 (1pzs.), 20x40,6x1,2 (1pzs.)

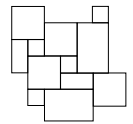

SUGGESTED LAYOUT
EJEMPLO COLOCACIÓN
EJEMPLE DE POSE



Floor Coverings Multiformato Sahara Anticato

LIMESTONE / CALIZA / PIERRE CALCAIRE



Cream Aged Anticato



Description	Format	Codes	Group	Pcs	m2	Kg
Cream Aged Anticato	Multiformato Multiformat	100099768 L108016751	G-242	1 x Cj 38 x Pal	0,72 x Cj 27,36 x Pal	28,94 x Cj 1099,98 x Pal

Butech: Colorstuk Rapid Gris

MULTIFORMATO / MULTIFORMATO / MULTIFORMATO

Packet is served. 0,72 m2 per pack, composed of 40,6x40,6x1,2 (2pzs.), 20x20x1,2 (2pzs.), 40,6x61,2x1,2 (1pzs.), 20x40,6x1,2 (1pzs.) / Se sirve por paquetes. 0,72 m² por paquete, compuesto por 40,6x40,6x1,2 (2pzs.), 20x20x1,2 (2pzs.), 40,6x61,2x1,2 (1pzs.), 20x40,6x1,2 (1pzs.) / Paquet est servi. 0,72 m2 par paquet, composé de 40,6x40,6x1,2 (2pzs.), 20x20x1,2 (2pzs.), 40,6x61,2x1,2 (1pzs.), 20x40,6x1,2 (1pzs.)

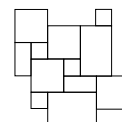

SUGGESTED LAYOUT
EJEMPLO COLOCACIÓN
EXEMPLE DE POSE



Floor Coverings Multiformato Cream Aged Anticato

LIMESTONE / CALIZA / PIERRE CALCAIRE



Vancouver Classico



Description	Format	Codes	Group	Pcs	m2	Kg
Vancouver Classico	30x60x1,4 cm	100146823	G-260	3 x Cj	0,54 x Cj	19,05 x Cj
	11 3/4"x23 5/8"x1/2"	L108026641		132 x Pal	23,76 x Pal	838,20 x Pal
Vancouver Classico	40x80x2 cm	100146082	G-267	1 x Cj	0,32 x Cj	16,24 x Cj
	15 3/4"x31 1/2"x3/4"	L105002311		78 x Pal	24,96 x Pal	1267,11 x Pal
Slab / Tabla / Tranche	2 cm	100155575	G-255	-	-	-
	3/4"	L105002491		-	-	-
Slab / Tabla / Tranche	3 cm	100155576	G-267	-	-	-
	1 1/8"	L105002511		-	-	-



Butech: Colorstuk Rapid Gris



Floor Coverings Vancouver Classico / Wall Coverings Vancouver Classico, Armour Caramel

LIMESTONE / CALIZA / PIERRE CALCAIRE



Ottawa Pulido



Description	Format	Codes	Group	Pcs	m2	Kg
Ottawa Pulido	30x60x1,5 cm	I00168288	G-257	3 x Cj	0,54 x Cj	23,39 x Cj
	11 3/4"x23 5/8"x5/8"	L112996301		132 x Pal	23,76 x Pal	1029,34 x Pal
Ottawa Pulido	40x80x1,5 cm	I00168314	G-265	1 x Cj	0,32 x Cj	13,86 x Cj
	15 3/4"x31 1/2"x5/8"	L105002751		78 x Pal	24,96 x Pal	1081,24 x Pal
Ottawa Pulido	60x60x2 cm	I00168330	G-267	1 x Cj	0,36 x Cj	20,80 x Cj
	23 5/8"x23 5/8"x3/4"	L105002971		40 x Pal	14,40 x Pal	831,80 x Pal
Slab / Tabla / Tranche	2 cm	I00176348	G-267	-	-	-
	3/4"	L105003161		-	-	-
Slab / Tabla / Tranche	3 cm	I00176337	G-279	-	-	-
	1 1/8"	L105003171		-	-	-

Butech: Colorstuk Rapid Beige



Floor Coverings Ottawa Pulido / Wall Coverings Amsterdam 2D Hexagon Beige

LIMESTONE / CALIZA / PIERRE CALCAIRE



Amsterdam Grey



Description	Format	Codes	Group	Pcs	m2	Kg
Amsterdam Grey	40x80x1,4cm 15 3/4"x31 1/2"x1/2"	100173151 L105003031	G-270	1 x Cj 78 x Pal	0,32 x Cj 24,96 x Pal	12,00 x Cj 936,00 x Pal
Amsterdam Grey	55x40/20x9,7x1,4 cm 21 5/8"-15 3/4"-9 7/8"x"3 7/8"x1/2"	100179863 L105003531	G-272	1 x Cj 40 x Pal	0,44 x Cj 17,85 x Pal	17,32 x Cj 692,76 x Pal

Butech: Colorstuk Rapid Gris



Each box contains a single 40x80x1,4 cm piece. These pieces have two different textures. / Cada caja contiene una pieza de 40x80x1,4 cm. Estas piezas presentan dos texturas diferentes. / Chaque boîte contient une pièce de 40x80x1,4 cm. Ces pièces présentent deux textures différentes.

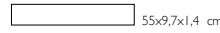

Each box contains 6 No. pieces 55x9,7x1,4 cm, 6 No. pieces 40x9,7x1,4 cm and 6 No. pieces 20x9,7x1,4 cm. All formats have two different textures. / Cada caja contiene 6 piezas de 55x9,7x1,4 cm, 6 piezas de 40x9,7x1,4 cm y 6 piezas de 20x9,7x1,4 cm. Todos los formatos presentan dos texturas diferentes. / Chaque boîte contient 6 pièces de 55x10x1 cm, 6 pièces de 40x9,7x1,4 cm et 6 pièces de 20x9,7x1,4 cm. Tous les formats présentent deux textures différentes.



Amsterdam 2D Hexagon Grey



Description	Format	Codes	Group	Pcs	m2	Kg
Amsterdam 2D Hexagon Grey	19x19x1-1,4 cm 7 1/2"x7 1/2"x3/8"-1/2"	100183929 L108040311	G-280	24 x Cj 792 x Pal	0,75 x Cj 24,79 x Pal	21,50 x Cj 709,63 x Pal

No supported grouting
No admite rejuntado
Ne peut pas être jointoyé.

*Minimum order one box. Only full boxes.
Venta mínima una caja. Sólo cajas completas.
Unité de vente minimum par boîte. Uniquement boîtes complètes.

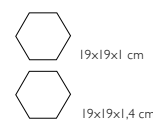

Each box contains 16 No. pieces 19x19x1 cm and 8 No. pieces 19x19x1,4 cm. Both formats have two different textures. / Cada caja contiene 16 piezas de 19x19x1 cm y 8 piezas de 19x19x1,4 cm. Ambos formatos presentan dos texturas diferentes. / Chaque boîte contient 16 pièces de 19x19x1 cm et 8 pièces de 19x19x1,4 cm. Les deux formats présentent deux textures différentes.

LIMESTONE / CALIZA / PIERRE CALCAIRE



Amsterdam Wall Grey



Description	Format	Codes	Group	Pcs	m2	Kg
Amsterdam Wall Grey	55/40/25x10x1 cm 21 5/8"-15 3/4"-9 7/8"x3 7/8"x3/8"	I00173145 L105003041	G-272	1 x Cj 24 x Pal	0,06 x Cj 1,32 x Pal	18,00 x Cj 432,00 x Pal

Butech: Colorstuk Rapid Gris

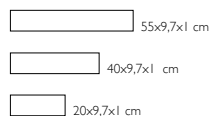

Each box contains 6 No. pieces 55x9,7x1 cm, 6 No. pieces 40x9,7x1 cm and 6 No. pieces 20x9,7x1 cm. All formats have two different textures. / Cada caja contiene 6 piezas de 55x9,7x1 cm, 6 piezas de 40x9,7x1 cm y 6 piezas de 20x9,7x1 cm. Todos los formatos presentan dos texturas diferentes. / Chaque boîte contient 6 pièces de 55x10x1 cm, 6 pièces de 40x9,7x1 cm et 6 pièces de 20x9,7x1 cm. Tous les formats présentent deux textures différentes.



Amsterdam Hexagon Grey



Description	Format	Codes	Group	Pcs	m2	Kg
Amsterdam Hexagon Grey	19x19x1,4 cm 7 1/2"x7 1/2"x1/2"	I00179858 L105003771	G-280	19 x Cj 627 x Pal	0,59 x Cj 19,62 x Pal	19 x Cj 627 x Pal

Butech: Colorstuk Rapid Gris

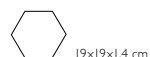

Each box contains 19 No. pieces 19x19x1,4 cm. These pieces have two different textures. / Cada caja contiene 19 piezas de 19x19x1,4 cm. Estas piezas presentan dos texturas diferentes. / Chaque boîte contient 19 pièces de 19x19x1,4 cm. Ces pièces présentent deux textures différentes.

LIMESTONE / CALIZA / PIERRE CALCAIRE



Amsterdam Beige



Description	Format	Codes	Group	Pcs	m2	Kg
Amsterdam Beige	40x80x1,4cm 15 3/4"x31 1/2"x1/2"	100173170 L105003021	G-270	1 x Cj 78 x Pal	0,32 x Cj 24,96 x Pal	12,00 x Cj 936,00 x Pal
Amsterdam Beige	55x40/20x9,7x1,4 cm 21 5/8"-15 3/4"-9 7/8"x3 7/8"x1/2"	100179882 L105003511	G-272	1 x Cj 40 x Pal	0,45 x Cj 17,84 x Pal	17,32 x Cj 692,76 x Pal

Butech: Colorstuk Rapid Beige



Each box contains a single 40x80x1,4 cm piece. These pieces have two different textures. / Cada caja contiene una pieza de 40x80x1,4 cm. Estás piezas presentan dos texturas diferentes. / Chaque boîte contient une pièce de 40x80x1,4 cm. Ces pièces présentent deux textures différentes.

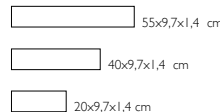

Each box contains 6 No. pieces 55x9,7x1,4 cm, 6 No. pieces 40x9,7x1,4 cm and 6 No. pieces 20x9,7x1,4 cm. All formats have two different textures. / Cada caja contiene 6 piezas de 55x9,7x1,4 cm, 6 piezas de 40x9,7x1,4 cm y 6 piezas de 20x9,7x1,4 cm. Todos los formatos presentan dos texturas diferentes. / Chaque boîte contient 6 pièces de 55x10x1 cm, 6 pièces de 40x9,7x1,4 cm et 6 pièces de 20x9,7x1,4 cm. Tous les formats présentent deux textures différentes.



Amsterdam 2D Hexagon Beige



Description	Format	Codes	Group	Pcs	m2	Kg
Amsterdam 2D Hexagon Beige	19x19x1,-1,4 cm 7 1/2"x7 1/2"x3/8"-1/2"	100183944 L108040321	G-280	24 x Cj 792 x Pal	0,75 x Cj 24,79 x Pal	21,50 x Cj 709,63 x Pal

No supported grouting
No admite rejuntado
Ne peut pas être jointoyé.

*Minimum order one box. Only full boxes.
Venta mínima una caja. Sólo cajas completas.
Unité de vente minimum par boîte. Uniquement boîtes complètes.

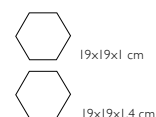

Each box contains 16 No. pieces 19x19x1 cm and 8 No. pieces 19x19x1,4 cm. Both formats have two different textures. / Cada caja contiene 16 piezas de 19x19x1 cm y 8 piezas de 19x19x1,4 cm. Ambos formatos presentan dos texturas diferentes. / Chaque boîte contient 16 pièces de 19x19x1 cm et 8 pièces de 19x19x1,4 cm. Les deux formats présentent deux textures différentes.

LIMESTONE / CALIZA / PIERRE CALCAIRE



Amsterdam Wall Beige



Description	Format	Codes	Group	Pcs	m2	Kg
Amsterdam Wall Beige	55/40/25x10x1 cm 21 5/8"-15 3/4"-9 7/8"x3 7/8"x3/8"	I00173152 L105003051	G-272	1 x Cj 24 x Pal	0,06 x Cj 1,32 x Pal	18,00 x Cj 432,00 x Pal

Butech: Colorstuk Rapid Beige

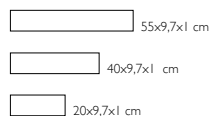

Each box contains 6 No. pieces 55x9,7x1 cm, 6 No. pieces 40x9,7x1 cm and 6 No. pieces 20x9,7x1 cm. All formats have two different textures. / Cada caja contiene 6 piezas de 55x9,7x1 cm, 6 piezas de 40x9,7x1 cm y 6 piezas de 20x9,7x1 cm. Todos los formatos presentan dos texturas diferentes. / Chaque boîte contient 6 pièces de 55x10x1 cm, 6 pièces de 40x9,7x1 cm et 6 pièces de 20x9,7x1 cm. Tous les formats présentent deux textures différentes.



Amsterdam Hexagon Beige



Description	Format	Codes	Group	Pcs	m2	Kg
Amsterdam Hexagon Beige	19x19x1,4 cm 7 1/2"x7 1/2"x1/2"	I00179857 L105003781	G-280	19 x Cj 627 x Pal	0,59 x Cj 19,62 x Pal	19 x Cj 627 x Pal

Butech: Colorstuk Rapid Beige

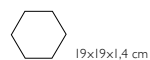

Each box contains 19 No. pieces 19x19x1,4 cm. These pieces have two different textures. / Cada caja contiene 19 piezas de 19x19x1,4 cm. Estas piezas presentan dos texturas diferentes. / Chaque boîte contient 19 pièces de 19x19x1,4 cm. Ces pièces présentent deux textures différentes.



Floor Coverings Desert Sandstone Classico / Wall Coverings Desert Sandstone Classico

SANDSTONE ARENISCA GRÈS

.....

Desert Sandstone
Blue Sandstone



SANDSTONE / ARENISCA / GRÈS



Desert Sandstone Classico



Description	Format	Codes	Group	Pcs	m2	Kg
Desert Sandstone Classico	40x80x2 cm 15 3/4"x31 1/2"x3/4"	100120889 L107500471	G-255	1 x Cj 78 x Pal	0,32 x Cj 24,96 x Pal	15,87 x Cj 1238 x Pal
Slab / Tabla / Tranche	2 cm 3/4"	100155570 L107500531	G-232	- -	- -	- -
Slab / Tabla / Tranche	3 cm 1 1/8"	100155571 L107500541	G-238	- -	- -	- -

Butech: Colorstuk Rapid Gris



Floor Coverings Desert Sandstone Classico / Wall Coverings Desert Sandstone Classico, Elite Brick Creams Complementary Products W-Tower Nogal Intense

SANDSTONE / ARENISCA / GRÈS



Blue Sandstone Classico



Description	Format	Codes	Group	Pcs	m2	Kg
Blue Sandstone Classico	30x60x1.5 cm	I00168307	G-257	3 x Cj	0.54 x Cj	21.60 x Cj
	11 3/4"x23 5/8"x5/8"	L112995831		132 x Pal	23.76 x Pal	950.40 x Pal
Blue Sandstone Classico	40x80x1.5 cm	I00168321	G-263	1 x Cj	0.32 x Cj	12 x Cj
	15 3/4"x31 1/2"x5/8"	L108035341		78 x Pal	24.96 x Pal	936 x Pal
Slab / Tabla / Tranche	2 cm	I00179380	G-255	-	-	-
	3/4"	L107501071		-	-	-
Slab / Tabla / Tranche	3 cm	I00179355	G-268	-	-	-
	1 1/8"	L107501061		-	-	-

Butech: Colorstuk Rapid Gris



Floor Coverings Blue Sandstone / Wall Coverings Wood Wall Bronze



Floor: Coverings Kathmandu Pulido / Wall Coverings Kathmandu Natural Home, Wood Feel / Complementary Products Trend Persian White, Future Persian White

SLATE PIZARRA ARDOISE



Bhutan
Patagonia
Nepal
Bombay
Delhi
Fidji
Kathmandu



SLATE / PIZARRA / ARDOISE



Bhutan Natural

- BIOPROT
- MATT
- SLIGHT COLOR VARIATION
- ORIGIN EUROPE
- INDOOR FLOORING
- INDOOR WALL COVERING
- OUTDOOR FLOORING
- OUTDOOR WALL COVERING
- SHOWER WALL COVERINGS
- COUNTERTOPS
- POOL SURROUNDINGS
- HIGH TRAFFIC
- RAMP CLASSIFICATION

Description	Format	Codes	Group	Pcs	m2	Kg
Bhutan Natural	30x60x1.2 cm 11 3/4"x23 5/8"x1/2"	100069634 L112995111	G-242	4 x Cj 176 x Pal	0,72 x Cj 31,68 x Pal	23,76 x Cj 1045,44 x Pal
Bhutan Natural	40x80x2 cm 15 3/4"x31 1/2"x3/4"	100081435 L106200181	G-270	1 x Cj 78 x Pal	0,32 x Cj 24,96 x Pal	19,23 x Cj 1499,94 x Pal



Butech: Colorstuk Rapid Antracita



Floor Coverings Desert Sandstone Classico / Wall Coverings Bhutan Natural

SLATE / PIZARRA / ARDOISE



Patagonia Home



Description	Format	Codes	Group	Pcs	m2	Kg
Patagonia Home	30x60x1 cm 11 3/4"x23 5/8"x3/8"	I00000176 LI12952031	G-238	4 x Cj 176 x Pal	0,72 x Cj 31,66 x Pal	26,28 x Cj 1156,32 x Pal
Patagonia Home	60x60x1 cm 23 5/8"x23 5/8"x3/8"	I00007870 LI16648011	G-244	2 x Cj 92 x Pal	0,72 x Cj 33,12 x Pal	20,95 x Cj 963,61 x Pal
Patagonia Home	160x60x2 cm 63"x23 5/8"x3/4"	I00001538 LI50301031	G-263	1 x Cj 21 x Pal	0,96 x Cj 20,19 x Pal	56,30 x Cj 1182,30 x Pal

Butech: Colorstuk Rapid Antracita



Floor Coverings Patagonia Home / Wall Coverings Patagonia Home, Globe Stick Nepal

SLATE / PIZARRA / ARDOISE

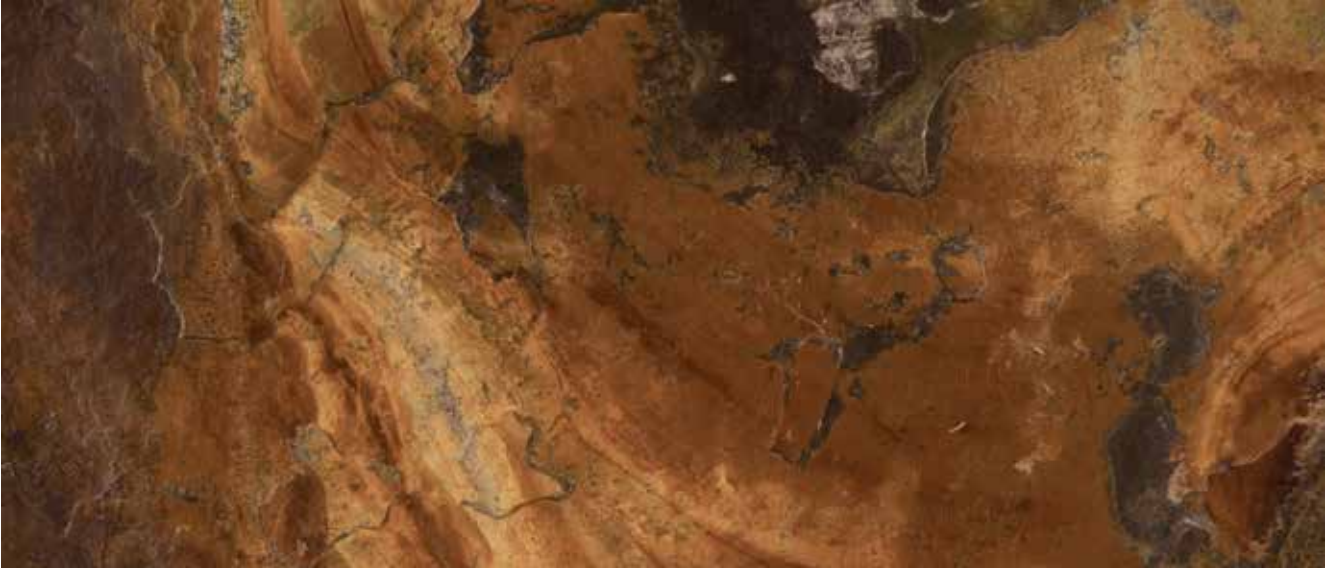

Nepal Natural



Description	Format	Codes	Group	Pcs	m2	Kg
Nepal Natural	30x60x1.2-1.4 cm 11 3/4"x23 5/8"x1/2"	100069167 L112995101	G-238	3 x Cj 132 x Pal	0,54 x Cj 23,76 x Pal	19,07 x Cj 839 x Pal
Nepal Natural	60x90x1.4-1.8 cm 23 5/8"x35 3/8"x1/2"-3/4"	100081419 L151501511	G-255	1 x Cj 46 x Pal	0,54 x Cj 24,84 x Pal	23,14 x Cj 1064,71 x Pal



Butech: Colorstuk Rapid Cemento



Wall Coverings Nepal Natural

SLATE / PIZARRA / ARDOISE



Bombay Natural Home

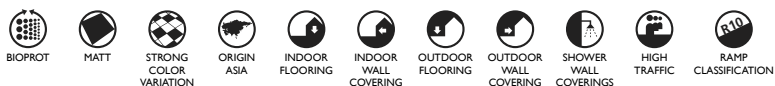

Description	Format	Codes	Group	Pcs	m2	Kg
Bombay Natural Home	30x60x1,2 cm 11 3/4"x23 5/8"x1/2"	100065522 L108005901	G-240	3 x Cj 132 x Pal	0,54 x Cj 23,76 x Pal	20,25 x Cj 891 x Pal
Bombay Natural Home	40x80x1,5 cm 15 3/4"x31 1/2"x5/8"	100078649 L106200141	G-252	1 x Cj 78 x Pal	0,32 x Cj 24,96 x Pal	14,10 x Cj 1100 x Pal

Butech: Colorstuk Rapid Caramelo



Bombay Pulido



Description	Format	Codes	Group	Pcs	m2	Kg
Bombay Pulido	30x60x1,2 cm 11 3/4"x23 5/8"x1/2"	100065786 L106400011	G-242	4 x Cj 176 x Pal	0,72 x Cj 31,68 x Pal	26,81 x Cj 1179,55 x Pal
Bombay Pulido	40x80x1,5 cm 15 3/4"x31 1/2"x5/8"	100080210 L106200151	G-255	1 x Cj 78 x Pal	0,32 x Cj 24,96 x Pal	13,46 x Cj 1050 x Pal

Butech: Colorstuk Rapid Caramelo

SLATE / PIZARRA / ARDOISE



Delhi Natural Home



Description	Format	Codes	Group	Pcs	m2	Kg
Delhi Natural Home	30x60x1.2 cm 11 3/4"x23 5/8"x1/2"	100065523 L108005911	G-232	3 x Cj 132 x Pal	0,54 x Cj 23,76 x Pal	20,25 x Cj 891 x Pal
Delhi Natural Home	40x80x1.5 cm 15 3/4"x31 1/2"x5/8"	100078650 L106200131	G-242	1 x Cj 78 x Pal	0,32 x Cj 24,96 x Pal	14,10 x Cj 1100 x Pal

Butech: Colorstuk Rapid Cemento



Delhi Pulido



Description	Format	Codes	Group	Pcs	m2	Kg
Delhi Pulido	30x60x1.2 cm 11 3/4"x23 5/8"x1/2"	100082874 L106400021	G-238	4 x Cj 176 x Pal	0,72 x Cj 31,68 x Pal	28,19 x Cj 1240,45 x Pal
Delhi Pulido	40x80x1.5 cm 15 3/4"x31 1/2"x5/8"	100080212 L106200161	G-244	1 x Cj 78 x Pal	0,32 x Cj 24,96 x Pal	14,10 x Cj 1100 x Pal

Butech: Colorstuk Rapid Cemento

SLATE / PIZARRA / ARDOISE



Fidji Natural Home



Description	Format	Codes	Group	Pcs	m2	Kg
Fidji Natural Home	40x80x1,5 cm 15 3/4"x31 1/2"x5/8"	100099457 L107500421	G-255	1 x Cj 78 x Pal	0,32 x Cj 24,96 x Pal	14,10 x Cj 1100 x Pal

Butech: Colorstuk Rapid Cemento / Antracita



Floor Coverings Fidji Natural Home / Complementary Products Round Persian White Classico, Hampton Nogal Warm, Khoa Persian White

SLATE / PIZARRA / ARDOISE



Kathmandu Natural Home



Description	Format	Codes	Group	Pcs	m2	Kg
Kathmandu Natural Home	30x60x1.2 cm	100090983	G-244	3 x Cj	0,54 x Cj	21,78 x Cj
	11 3/4"x23 5/8"x1/2"	L107000321		132 x Pal	23,76 x Pal	958,45 x Pal
Kathmandu Natural Home	40x80x1.5 cm	100086259	G-257	1 x Cj	0,32 x Cj	14,62 x Cj
	15 3/4"x31 1/2"x5/8"	L107000161		78 x Pal	24,96 x Pal	1140 x Pal

Butech: Colorstuk Rapid Manhattan

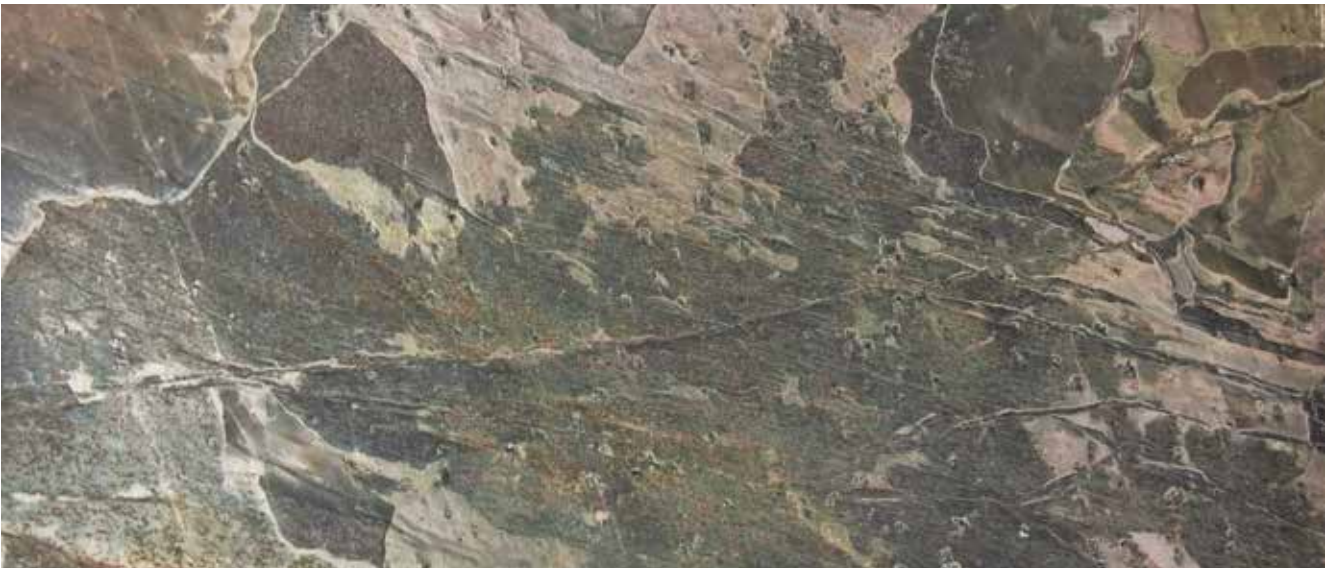

Kathmandu Pulido



Description	Format	Codes	Group	Pcs	m2	Kg
Kathmandu Pulido	30x60x1.2 cm	100090984	G-242	4 x Cj	0,72 x Cj	24,70 x Cj
	11 3/4"x23 5/8"x1/2"	L107000331		176 x Pal	31,68 x Pal	1086,62 x Pal
Kathmandu Pulido	40x80x1.5 cm	100086260	G-255	1 x Cj	0,32 x Cj	13,93 x Cj
	15 3/4"x31 1/2"x5/8"	L107000131		78 x Pal	24,96 x Pal	1086,70 x Pal

Butech: Colorstuk Rapid Manhattan

SLATE / PIZARRA / ARDOISE



Floor Coverings Kathmandu Pulido / Wall Coverings Kathmandu Natural Home, Wood Feel / Complementary Products Trend Persian White Future Persian White

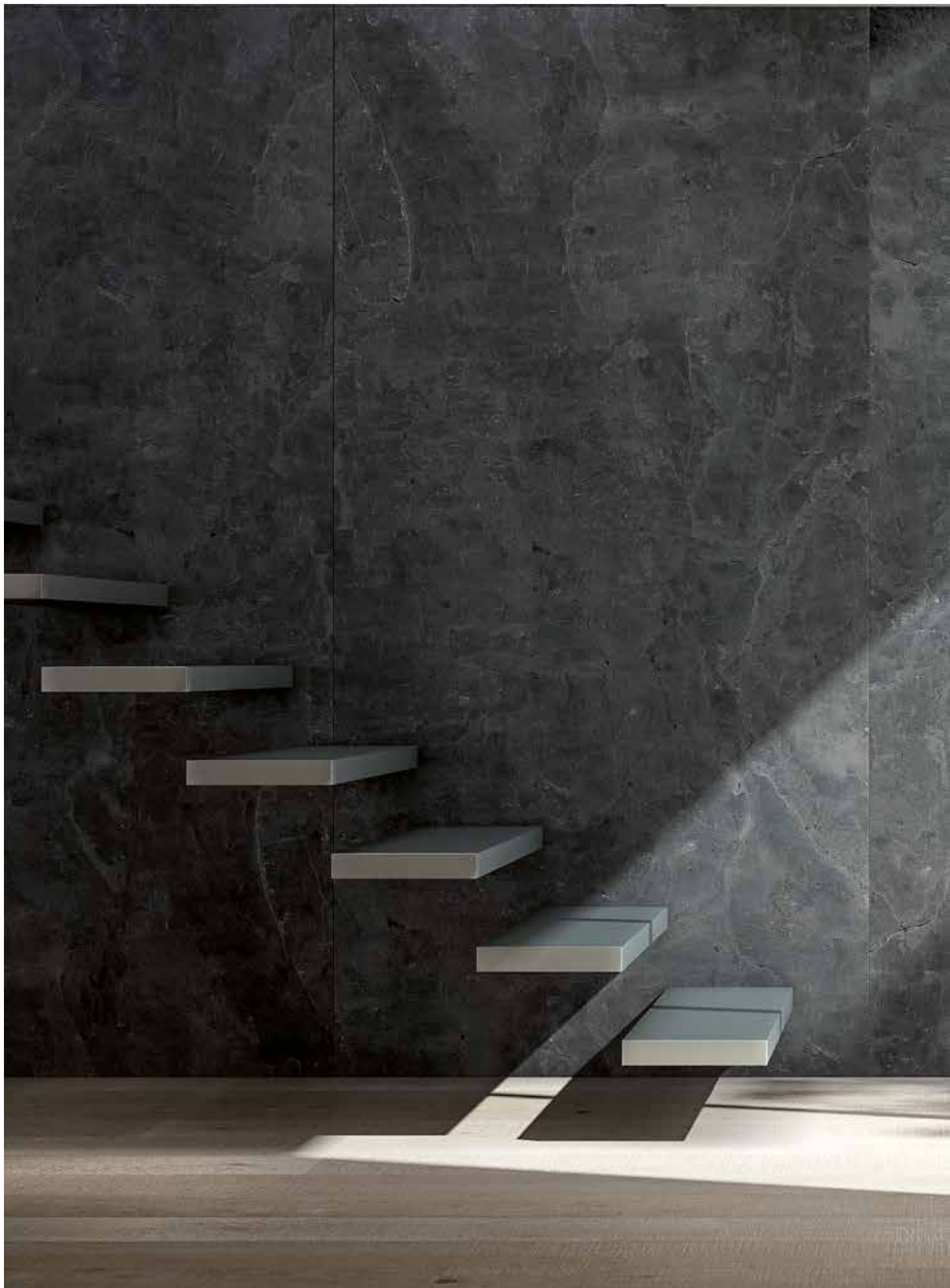

Floor Coverings Eden Texture 1L Almond / Wall Coverings Airslate Graphite

AIRSLATE

.....

Bombay
Delhi
Kathmandu
Forest
Kashmir
Metal
Graphite

AIRSLATE



Airslate Bombay



Description	Format	Codes	Group	Pcs	m2	Kg
Airslate Bombay	120x240x0,2-0,4 cm 47 1/4"x94 1/2"x1/16"-3/16"	I00161532 L106200891	G-238	5 x Cj 110 x Pal	14,40 x Cj 316,80 x Pal	60 x Cj 1320 x Pal
Airslate Bombay	120x60x0,2-0,4 cm 23 5/8"x47 1/4"x1/16"-3/16"	I00179699 L107001001	G-234	15 x Cj 135 x Pal	10,80 x Cj 97,20 x Pal	41,52 x Cj 373,68 x Pal



Butech: Colorstuk Rapid Caramelo

- C1. Slate / Pizarra / Ardoise
- C2. Adhesive / Adhesivo / Adhésif
- C3. Fiber Glass / Fibra de vidrio / Fibre de verre
- C4. Background / Base / Fond

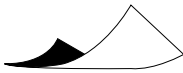

FLEXIBLE MATERIAL / MATERIAL FLEXIBLE / MATÉRIAU FLEXIBLE

Airslate is manufactured with a fibreglass layer which reinforces the structure, provides greater flexibility, and enables installation on curved areas with a radius of up to 25 cm. / Airslate está realizado con una capa de fibra de vidrio que refuerza su estructura y le otorga un amplio grado de flexión, lo que permite ser instalado en zonas curvadas con un radio de hasta 25 cm. / Airslate est fabriqué avec une couche en fibre de verre qui renforce la structure et lui confère une grande capacité de flexion, ce qui permet de l'installer dans des espaces courbes d'un rayon pouvant aller jusqu'à 25 cm.



Airslate Delhi



Description	Format	Codes	Group	Pcs	m2	Kg
Airslate Delhi	120x240x0,2-0,4 cm 47 1/4"x94 1/2"x1/16"-3/16"	I00161533 L106200931	G-238	5 x Cj 110 x Pal	14,40 x Cj 316,80 x Pal	60 x Cj 1320 x Pal
Airslate Delhi	120x60x0,2-0,4 cm 23 5/8"x47 1/4"x1/16"-3/16"	I00179714 L107001021	G-234	15 x Cj 135 x Pal	10,80 x Cj 97,2 x Pal	41,52 x Cj 373,68 x Pal

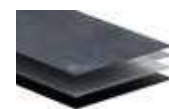

Butech: Colorstuk Rapid Cemento

- C1. Slate / Pizarra / Ardoise
- C2. Adhesive / Adhesivo / Adhésif
- C3. Fiber Glass / Fibra de vidrio / Fibre de verre
- C4. Background / Base / Fond



FLEXIBLE MATERIAL / MATERIAL FLEXIBLE / MATÉRIAU FLEXIBLE

Airslate is manufactured with a fibreglass layer which reinforces the structure, provides greater flexibility, and enables installation on curved areas with a radius of up to 25 cm. / Airslate está realizado con una capa de fibra de vidrio que refuerza su estructura y le otorga un amplio grado de flexión, lo que permite ser instalado en zonas curvadas con un radio de hasta 25 cm. / Airslate est fabriqué avec une couche en fibre de verre qui renforce la structure et lui confère une grande capacité de flexion, ce qui permet de l'installer dans des espaces courbes d'un rayon pouvant aller jusqu'à 25 cm.

AIRSLATE



Airslate Kathmandu



Description	Format	Codes	Group	Pcs	m2	Kg
Airslate Kathmandu	120x240x0.2-0.4 cm 47 1/4"x94 1/2"x1/16"-3/16"	100161516 L106200911	G-238	5 x Cj 110 x Pal	14,40 x Cj 316,80 x Pal	60 x Cj 1320 x Pal
Airslate Kathmandu	120x60x0.2-0.4 cm 23 5/8"x47 1/4"x1/16"-3/16"	100179715 L107001011	G-234	15 x Cj 135 x Pal	10,80 x Cj 97,2 x Pal	41,52 x Cj 373,68 x Pal

Butech: Colorstuk Rapid Manhattan

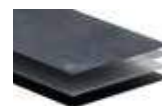

- C1. Slate / Pizarra / Ardoise
- C2. Adhesive / Adhesivo / Adhésif
- C3. Fiber Glass / Fibra de vidrio / Fibre de verre
- C4. Background / Base / Fond



FLEXIBLE MATERIAL / MATERIAL FLEXIBLE / MATÉRIAU FLEXIBLE

Airslate is manufactured with a fibreglass layer which reinforces the structure, provides greater flexibility, and enables installation on curved areas with a radius of up to 25 cm. / Airslate está realizado con una capa de fibra de vidrio que refuerza su estructura y le otorga un amplio grado de flexión, lo que permite ser instalado en zonas curvadas con un radio de hasta 25 cm. / Airslate est fabriqué avec une couche en fibre de verre qui renforce la structure et lui confère une grande capacité de flexion, ce qui permet de l'installer dans des espaces courbes d'un rayon pouvant aller jusqu'à 25 cm.



Airslate Forest



Description	Format	Codes	Group	Pcs	m2	Kg
Airslate Forest	120x240x0.2-0.4 cm 47 1/4"x94 1/2"x1/16"-3/16"	100161514 L106200901	G-238	5 x Cj 110 x Pal	14,40 x Cj 316,80 x Pal	60 x Cj 1320 x Pal
Airslate Forest	120x60x0.2-0.4 cm 23 5/8"x47 1/4"x1/16"-3/16"	100179721 L107001031	G-234	15 x Cj 135 x Pal	10,80 x Cj 97,2 x Pal	41,52 x Cj 373,68 x Pal

Butech: Colorstuk Rapid Manhattan



- C1. Slate / Pizarra / Ardoise
- C2. Adhesive / Adhesivo / Adhésif
- C3. Fiber Glass / Fibra de vidrio / Fibre de verre
- C4. Background / Base / Fond



FLEXIBLE MATERIAL / MATERIAL FLEXIBLE / MATÉRIAU FLEXIBLE

Airslate is manufactured with a fibreglass layer which reinforces the structure, provides greater flexibility, and enables installation on curved areas with a radius of up to 25 cm. / Airslate está realizado con una capa de fibra de vidrio que refuerza su estructura y le otorga un amplio grado de flexión, lo que permite ser instalado en zonas curvadas con un radio de hasta 25 cm. / Airslate est fabriqué avec une couche en fibre de verre qui renforce la structure et lui confère une grande capacité de flexion, ce qui permet de l'installer dans des espaces courbes d'un rayon pouvant aller jusqu'à 25 cm.

AIRSLATE



Airslate Kashmir



Description	Format	Codes	Group	Pcs	m2	Kg
Airslate Kashmir	120x240x0.2-0.4 cm 47 1/4"x94 1/2"x1/16"-3/16"	100161506 L106200871	G-238	5 x Cj 110 x Pal	14,40 x Cj 316,80 x Pal	60 x Cj 1320 x Pal
Airslate Kashmir	120x60x0.2-0.4 cm 23 5/8"x47 1/4"x1/16"-3/16"	100179705 L107001041	G-234	15 x Cj 135 x Pal	10,80 x Cj 97,2 x Pal	41,52 x Cj 373,68 x Pal

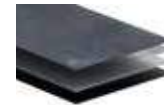

Butech: Colorstuk Rapid Cemento

- C1. Slate / Pizarra / Ardoise
- C2. Adhesive / Adhesivo / Adhésif
- C3. Fiber Glass / Fibra de vidrio / Fibre de verre
- C4. Background / Base / Fond

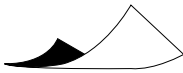

FLEXIBLE MATERIAL / MATERIAL FLEXIBLE / MATÉRIAU FLEXIBLE

Airslate is manufactured with a fibreglass layer which reinforces the structure, provides greater flexibility, and enables installation on curved areas with a radius of up to 25 cm. / Airslate está realizado con una capa de fibra de vidrio que refuerza su estructura y le otorga un amplio grado de flexión, lo que permite ser instalado en zonas curvadas con un radio de hasta 25 cm. / Airslate est fabriqué avec une couche en fibre de verre qui renforce la structure et lui confère une grande capacité de flexion, ce qui permet de l'installer dans des espaces courbes d'un rayon pouvant aller jusqu'à 25 cm.



Airslate Metal



Description	Format	Codes	Group	Pcs	m2	Kg
Airslate Metal	120x240x0.2-0.4 cm 47 1/4"x94 1/2"x1/16"-3/16"	100161526 L106200921	G-238	5 x Cj 110 x Pal	14,40 x Cj 316,80 x Pal	60 x Cj 1320 x Pal
Airslate Metal	120x60x0.2-0.4 cm 23 5/8"x47 1/4"x1/16"-3/16"	100179732 L107001061	G-234	15 x Cj 135 x Pal	10,80 x Cj 97,2 x Pal	41,52 x Cj 373,68 x Pal

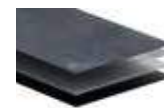

Butech: Colorstuk Rapid Cemento

- C1. Slate / Pizarra / Ardoise
- C2. Adhesive / Adhesivo / Adhésif
- C3. Fiber Glass / Fibra de vidrio / Fibre de verre
- C4. Background / Base / Fond



FLEXIBLE MATERIAL / MATERIAL FLEXIBLE / MATÉRIAU FLEXIBLE

Airslate is manufactured with a fibreglass layer which reinforces the structure, provides greater flexibility, and enables installation on curved areas with a radius of up to 25 cm. / Airslate está realizado con una capa de fibra de vidrio que refuerza su estructura y le otorga un amplio grado de flexión, lo que permite ser instalado en zonas curvadas con un radio de hasta 25 cm. / Airslate est fabriqué avec une couche en fibre de verre qui renforce la structure et lui confère une grande capacité de flexion, ce qui permet de l'installer dans des espaces courbes d'un rayon pouvant aller jusqu'à 25 cm.

AIRSLATE



Airslate Graphite



Description	Format	Codes	Group	Pcs	m2	Kg
Airslate Graphite	120x240x0,2-0,4 cm 47 1/4"x94 1/2"x1/16"-3/16"	100161515 LI06200941	G-238	5 x Cj 110 x Pal	14,40 x Cj 316,80 x Pal	60 x Cj 1320 x Pal
Airslate Graphite	120x60x0,2-0,4 cm 23 5/8"x47 1/4"x1/16"-3/16"	100179731 LI07001051	G-234	15 x Cj 135 x Pal	10,80 x Cj 97,2 x Pal	41,52 x Cj 373,68 x Pal

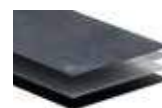

Butech: Colorstuk Rapid Cemento

- C1. Slate / Pizarra / Ardoise
- C2. Adhesive / Adhesivo / Adhésif
- C3. Fiber Glass / Fibra de vidrio / Fibre de verre
- C4. Background / Base / Fond



FLEXIBLE MATERIAL / MATERIAL FLEXIBLE / MATÉRIAU FLEXIBLE

Airslate is manufactured with a fibreglass layer which reinforces the structure, provides greater flexibility, and enables installation on curved areas with a radius of up to 25 cm. / Airslate está realizado con una capa de fibra de vidrio que refuerza su estructura y le otorga un amplio grado de flexión, lo que permite ser instalado en zonas curvadas con un radio de hasta 25 cm. / Airslate est fabriqué avec une couche en fibre de verre qui renforce la structure et lui confère une grande capacité de flexion, ce qui permet de l'installer dans des espaces courbes d'un rayon pouvant aller jusqu'à 25 cm.



Floor Coverings Authentic 1L Anthracite / Wall Coverings Airslate Graphite



Floor Coverings Habana Brown Classico / Wall Coverings Globe Brick Bhutan

GLOBE

.....

Brick
Stick
Castle
Wall

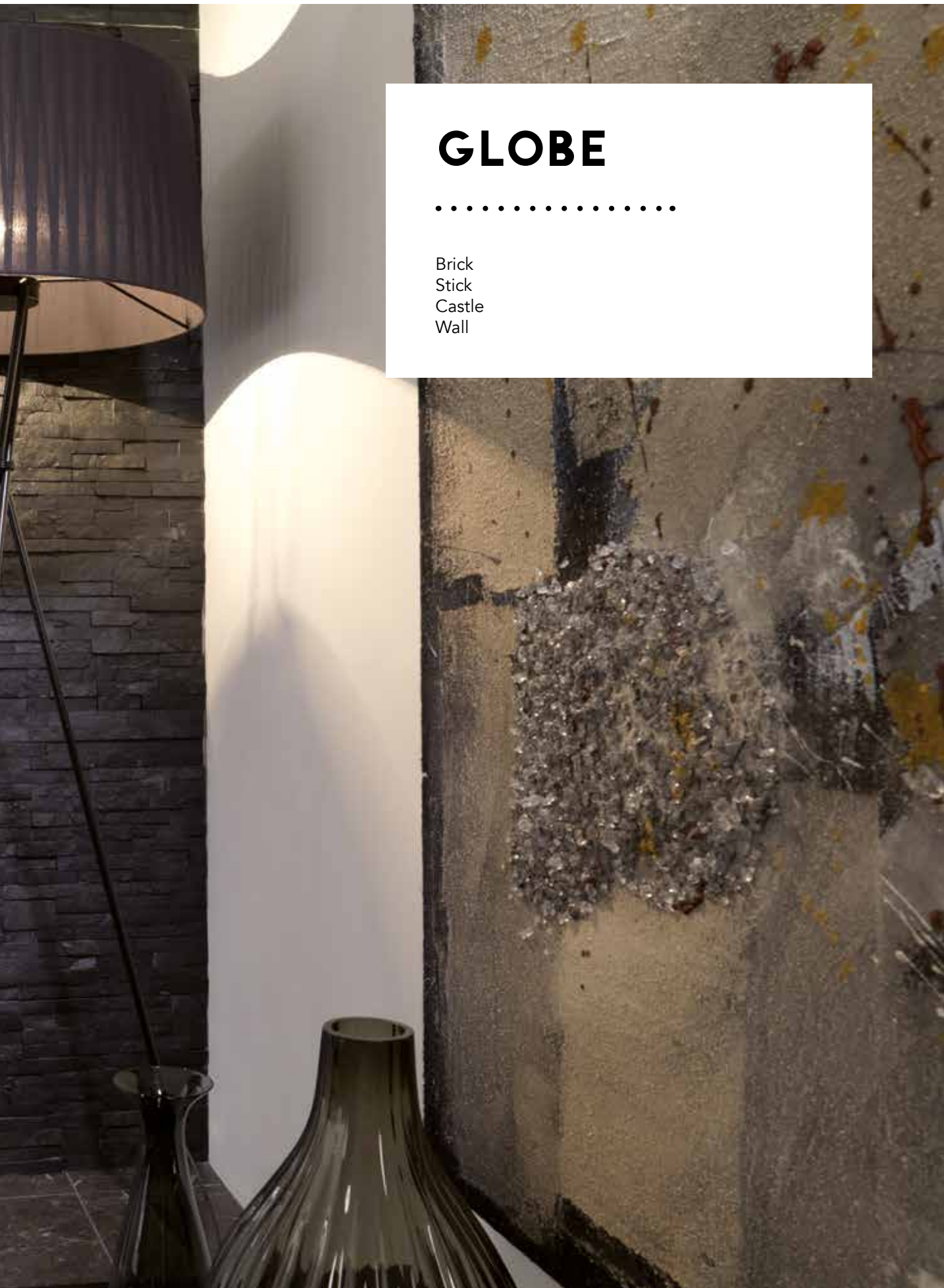

GLOBE



Globe Brick Nepal



SLATE / PIZARRA / ARDOISE

No supported grouting / No admite rejuntado / Ne peut pas être jointoyé.



Globe Brick Indira



QUARTZITE / CUARCITA / QUARTZITE

No supported grouting / No admite rejuntado / Ne peut pas être jointoyé.



Globe Brick Delhi



SLATE / PIZARRA / ARDOISE

No supported grouting / No admite rejuntado / Ne peut pas être jointoyé.



Globe Corner Brick Nepal



SLATE / PIZARRA / ARDOISE

No supported grouting / No admite rejuntado / Ne peut pas être jointoyé.



Globe Corner Brick Indira

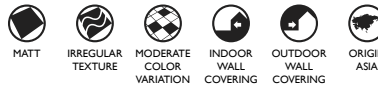

QUARTZITE / CUARCITA / QUARTZITE

No supported grouting / No admite rejuntado / Ne peut pas être jointoyé.



Globe Corner Brick Delhi



SLATE / PIZARRA / ARDOISE

No supported grouting / No admite rejuntado / Ne peut pas être jointoyé.

Description	Format	Codes	Group	Pcs	m2	Kg
Globe Brick Nepal	10x40x1.5-2.5 cm	100001583	G-260	10 x Cj	0,40 x Cj	26,19 x Cj
	3 7/8" x 15 3/4 x 3/4"-1"	L153201501		420 x Pal	16,80 x Pal	1099,98 x Pal
Globe Corner Brick Nepal	10x38x2-2.5 cm	100032187	G-263	10 x Cj	0,38 x Cj	19,77 x Cj
	3 7/8" x 15 x 3/4"-1"	L153201571		420 x Pal	15,96 x Pal	830,34 x Pal
Globe Brick Indira	10x40x2-2.5 cm	10004752	G-255	12 x Cj	0,48 x Cj	18,50 x Cj
	3 7/8" x 15 3/4 x 3/4"-1"	L153201581		504 x Pal	20,16 x Pal	777,17 x Pal
Globe Corner Brick Indira	10x38x2-2.5 cm	10004753	G-257	12 x Cj	0,45 x Cj	28,76 x Cj
	3 7/8" x 15 x 3/4"-1"	L153201591		504 x Pal	19,15 x Pal	1208,09 x Pal
Globe Brick Delhi	10x40x2-2.5 cm	100200281	G-249	10 x Cj	0,40 x Cj	15,83 x Cj
	3 7/8" x 15 3/4 x 3/4"-1"	L108043481		360 x Pal	14,40 x Pal	569,88 x Pal
Globe Corner Brick Delhi	10x38x2-2.5 cm	100060208	G-252	10 x Cj	0,38 x Cj	24,43 x Cj
	3 7/8" x 15 x 3/4"-1"	L153201641		420 x Pal	15,96 x Pal	1026,06 x Pal



GLOBE



Globe Brick Blanco Almeria



MARBLE / MARMOL / MARBRE

No supported grouting / No admite rejuntado /
Ne peut pas être jointoyé.



Globe Brick Bhutan



SLATE / PIZARRA / ARDOISE

No supported grouting / No admite rejuntado /
Ne peut pas être jointoyé.



Globe Brick Bombay

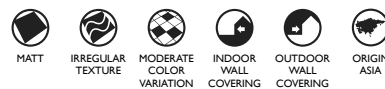

SLATE / PIZARRA / ARDOISE

No supported grouting / No admite rejuntado /
Ne peut pas être jointoyé.



Globe Corner Blanco Almeria



MARBLE / MARMOL / MARBRE

No supported grouting / No admite rejuntado /
Ne peut pas être jointoyé.



Globe Corner Brick Bhutan



SLATE / PIZARRA / ARDOISE

No supported grouting / No admite rejuntado /
Ne peut pas être jointoyé.



Globe Corner Brick Bombay

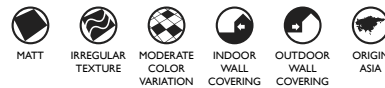

SLATE / PIZARRA / ARDOISE

No supported grouting / No admite rejuntado /
Ne peut pas être jointoyé.

Description	Format	Codes	Group	Pcs	m2	Kg
Globe Brick Blanco Almeria	10x40x2-2.5 cm	I00031998	G-282	10 x Cj	0,40 x Cj	17,85 x Cj
	3 7/8"x15 3/4x3/4"-1"	L153201541		420 x Pal	16,80 x Pal	749,70 x Pal
Globe Corner Brick Bco.Almeria	10x38x2-2.5 cm	I00032128	G-283	10 x Cj	0,38 x Cj	17,18 x Cj
	3 7/8"x15x3/4"-1"	L153201531		420 x Pal	15,96 x Pal	721,56 x Pal
Globe Brick Bhutan	10x40x2-2.5 cm	I00001585	G-249	12 x Cj	0,48 x Cj	21,37 x Cj
	3 7/8"x15 3/4x3/4"-1"	L153201521		504 x Pal	20,16 x Pal	897,62 x Pal
Globe Corner Brick Bhutan	10x38x2-2.5 cm	I00032184	G-252	12 x Cj	0,45 x Cj	18,02 x Cj
	3 7/8"x15x3/4"-1"	L153201551		504 x Pal	19,15 x Pal	757,01 x Pal
Globe Brick Bombay	10x40x2-2.5 cm	I00200280	G-249	10 x Cj	0,40 x Cj	15,83 x Cj
	3 7/8"x15 3/4x3/4"-1"	L108043491		360 x Pal	14,40 x Pal	569,88 x Pal
Globe Corner Brick Bombay	10x38x2-2.5 cm	I00060209	G-252	10 x Cj	0,38 x Cj	24,43 x Cj
	3 7/8"x15x3/4"-1"	L153201651		420 x Pal	15,96 x Pal	1026,06 x Pal

GLOBE



Globe Brick Lhasa



QUARTZITE / CUARCITA / QUARTZITE

No supported grouting / No admite rejuntado /
Ne peut pas être jointoyé.



Globe Stick Nepal



SLATE / PIZARRA / ARDOISE

No supported grouting / No admite rejuntado /
Ne peut pas être jointoyé.



Globe Stick Bhutan



SLATE / PIZARRA / ARDOISE

No supported grouting / No admite rejuntado /
Ne peut pas être jointoyé.



Globe Corner Brick Lhasa



QUARTZITE / CUARCITA / QUARTZITE

No supported grouting / No admite rejuntado /
Ne peut pas être jointoyé.



Globe Corner Stick Nepal

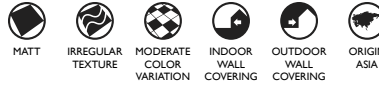

SLATE / PIZARRA / ARDOISE

No supported grouting / No admite rejuntado /
Ne peut pas être jointoyé.



Globe Corner Stick Bhutan



SLATE / PIZARRA / ARDOISE

No supported grouting / No admite rejuntado /
Ne peut pas être jointoyé.

Description	Format	Codes	Group	Pcs	m2	Kg
Globe Brick Lhasa	10x40x2-2.5 cm	100001584	G-270	10 x Cj	0,40 x Cj	24,32 x Cj
	3 7/8" x 15 3/4 x 3/4"-1"	L153201511		420 x Pal	16,80 x Pal	1021,44 x Pal
Globe Corner Brick Lhasa	10x38x2-2.5 cm	100032196	G-272	10 x Cj	0,38 x Cj	19,77 x Cj
	3 7/8" x 15 x 3/4"-1"	L153201561		420 x Pal	15,96 x Pal	830,34 x Pal
Globe Stick Nepal	10x40x2-2.5 cm	100001565	G-257	12 x Cj	0,48 x Cj	20,38 x Cj
	3 7/8" x 15 3/4 x 3/4"-1"	L151701001		504 x Pal	20,16 x Pal	856,29 x Pal
Globe Corner Stick Nepal	10x40x2-2.5 cm	100032191	G-260	12 x Cj	0,48 x Cj	21,21 x Cj
	3 7/8" x 15 3/4 x 3/4"-1"	L153201601		504 x Pal	20,16 x Pal	891,07 x Pal
Globe Stick Bhutan	10x40x2-2.5 cm	100001566	G-263	12 x Cj	0,48 x Cj	20,38 x Cj
	3 7/8" x 15 3/4 x 3/4"-1"	L151701021		504 x Pal	20,16 x Pal	856,29 x Pal
Globe Corner Stick Bhutan	10x40x2-2.5 cm	100032195	G-265	12 x Cj	0,48 x Cj	21,21 x Cj
	3 7/8" x 15 3/4 x 3/4"-1"	L153201621		504 x Pal	20,16 x Pal	891,07 x Pal

GLOBE



Globe Stick Mix Nepal Bhutan



SLATE / PIZARRA / ARDOISE

No supported grouting / No admite rejuntado /
Ne peut pas être jointoyé.



Globe Stick Mix Nepal Shannan



SLATE / PIZARRA / ARDOISE
QUARTZITE / CUARCITA / QUARTZITE

No supported grouting / No admite rejuntado /
Ne peut pas être jointoyé.



Globe Castle Burma



QUARTZITE / CUARCITA / QUARTZITE

No supported grouting / No admite rejuntado /
Ne peut pas être jointoyé.



Globe Corner Stick Mix Nepal Bhutan



SLATE / PIZARRA / ARDOISE

No supported grouting / No admite rejuntado /
Ne peut pas être jointoyé.



Globe Corner Stick Mix Nepal Shannan



SLATE / PIZARRA / ARDOISE
QUARTZITE / CUARCITA / QUARTZITE

No supported grouting / No admite rejuntado /
Ne peut pas être jointoyé.

Description	Format	Codes	Group	Pcs	m2	Kg
Globe Stick Mix Nepal Bhutan	10x40x1.2-2.5 cm 3 7/8"x15 3/4x1/2"-1"	I00099458 L106300241	G-255	8 x Cj 640 x Pal	0,32 x Cj 25,60 x Pal	11,92 x Cj 953,60 x Pal
Globe Corner Stick Mix Nepal Bhutan	10x40x1.2-2.5 cm 3 7/8"x15 3/4x1/2"-1"	I00114595 L108020671	G-257	8 x Cj 640 x Pal	0,32 x Cj 25,60 x Pal	14,14 x Cj 1131,52 x Pal
Globe Corner Stick Mix Nepal/Shan.	10x40x2-2.5 cm 3 7/8"x15 3/4x3/4"-1"	I00060207 L153201631	G-268	12 x Cj 504 x Pal	0,48 x Cj 20,16 x Pal	20,18 x Cj 847,73 x Pal
Globe Stick Mix Nepal/Shannan	10x40x2-2.5 cm 3 7/8"x15 3/4x3/4"-1"	I00057245 L106300001	G-270	12 x Cj 504 x Pal	0,48 x Cj 20,16 x Pal	21,42 x Cj 899,64 x Pal
Globe Castle Burma	10x40x2-2.5 cm 3 7/8"x15 3/4x3/4"-1"	I00086086 L106300111	G-255	10 x Cj 360 x Pal	0,40 x Cj 14,40 x Pal	21 x Cj 756 x Pal

GLOBE



Globe Wall Nepal



SLATE / PIZARRA / ARDOISE

No supported grouting / No admite rejuntado /
Ne peut pas être jointoyé.



Globe Wall Bhutan



SLATE / PIZARRA / ARDOISE

No supported grouting / No admite rejuntado /
Ne peut pas être jointoyé.



Globe Wall White

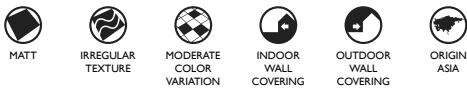

MARBLE / MARMOL / MARBRE

No supported grouting / No admite rejuntado /
Ne peut pas être jointoyé.

Description	Format	Codes	Group	Pcs	m2	Kg
Globe Wall Nepal	15x54,8x1,2-3,5 cm	100086108	G-238	6 x Cj	0,49 x Cj	20,68 x Cj
	5 7/8" x 21 5/8" x 1/2" - 1 3/8"	L119165211		180 x Pal	14,80 x Pal	620,46 x Pal
Globe Wall Bhutan	15x54,8x1,2-2,5 cm	100086107	G-238	6 x Cj	0,49 x Cj	23,34 x Cj
	5 7/8" x 21 5/8" x 1/2" - 1"	L119165231		180 x Pal	14,80 x Pal	700,20 x Pal
Globe Wall White	15x54,8x1,2-2,5 cm	100096194	G-249	6 x Cj	0,49 x Cj	28,75 x Cj
	21 5/8" x 5 7/8" x 1/2" / 1"	L108014841		180 x Pal	20,16 x Pal	862,50 x Pal

GLOBE



Globe Wall Burma



QUARTZITE / CUARCITA / QUARTZITE

No supported grouting / No admite rejuntado /
Ne peut pas être jointoyé.



Globe Wall Shannan



QUARTZITE / CUARCITA / QUARTZITE

No supported grouting / No admite rejuntado /
Ne peut pas être jointoyé.



Wall Coverings Globe Wall Burma

Description	Format	Codes	Group	Pcs	m2	Kg
Globe Wall Burma	15x54.8x1.2-2.5 cm	I00099459	G-246	7 x Cj	0.58 x Cj	27.53 x Cj
	21 5/8"x5 7/8"x1/2"-1"	L107000621		210 x Pal	17.26 x Pal	825.93 x Pal
Globe Wall Shannan	15x54.8x1.2-2.5 cm	I00086109	G-238	6 x Cj	0.49 x Cj	25.02 x Cj
	21 5/8"x5 7/8"x1/2"-1"	L119165221		180 x Pal	14.80 x Pal	750.60 x Pal





Wall Coverings Onix Lagoa / Floor Coverings Onix Lagoa

HERITAGE



- Aspen White Pulido
- Blanco Calacatta Pulido
- Statuario Altísimo
- Giallo Conte
- Port Monaco
- Port Cannes
- Onix Botafogo
- Onix Lagoa
- Onix Ipanema
- Onix Etnia
- Onix Lava

HERITAGE



Aspen White Pulido



Description	Format	Codes	Group	Pcs	m2	Kg
Slab / Tabla / Tranche	2 cm 3/4"	100200220 L108043291	G-280	-	-	-

Butech: Colorstuk Rapid Gris

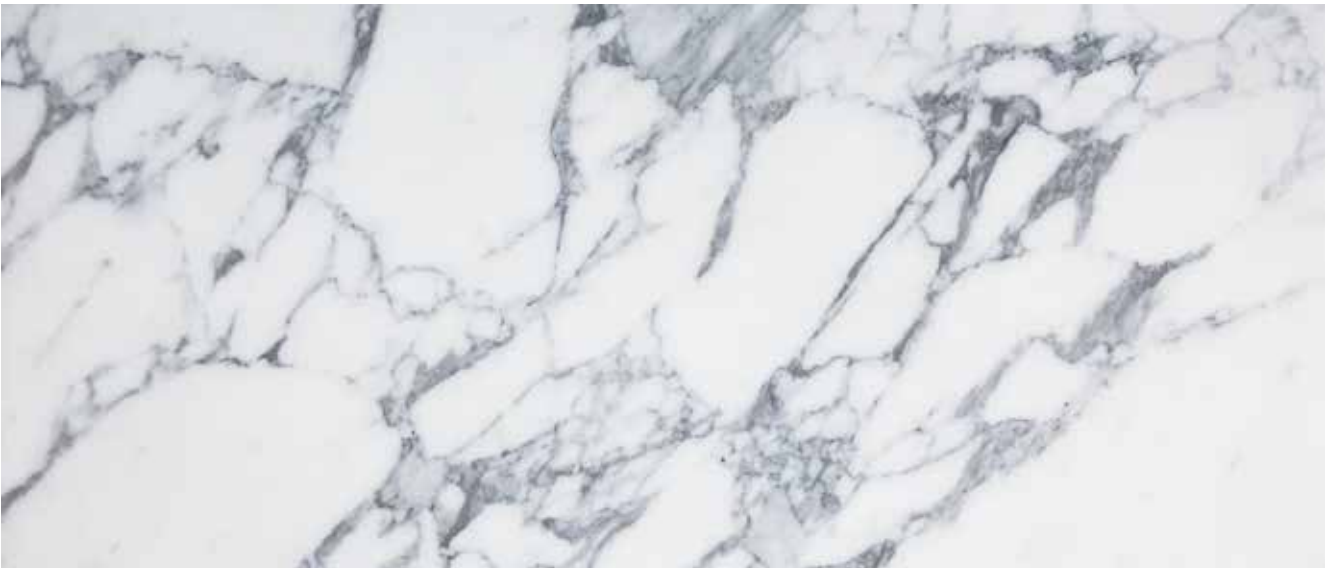

Blanco Calacatta Pulido



Description	Format	Codes	Group	Pcs	m2	Kg
Slab / Tabla / Tranche	2 cm 3/4"	100156918 L108030431	G-287	-	-	-

Butech: Colorstuk Rapid Gris

MARBLE / MÁRMOL / MARBRE



Statuario Altissimo



Butech: Colorstuk Rapid Gris

Description	Format	Codes	Group	Pcs	m2	Kg
Slab / Tabla / Tranche	2 cm 3/4"	I00146099 L108026401	G-291	-	-	-



Floor Coverings Blanco Calacatta Pulido / Wall Coverings Blanco Calacatta Pulido

HERITAGE

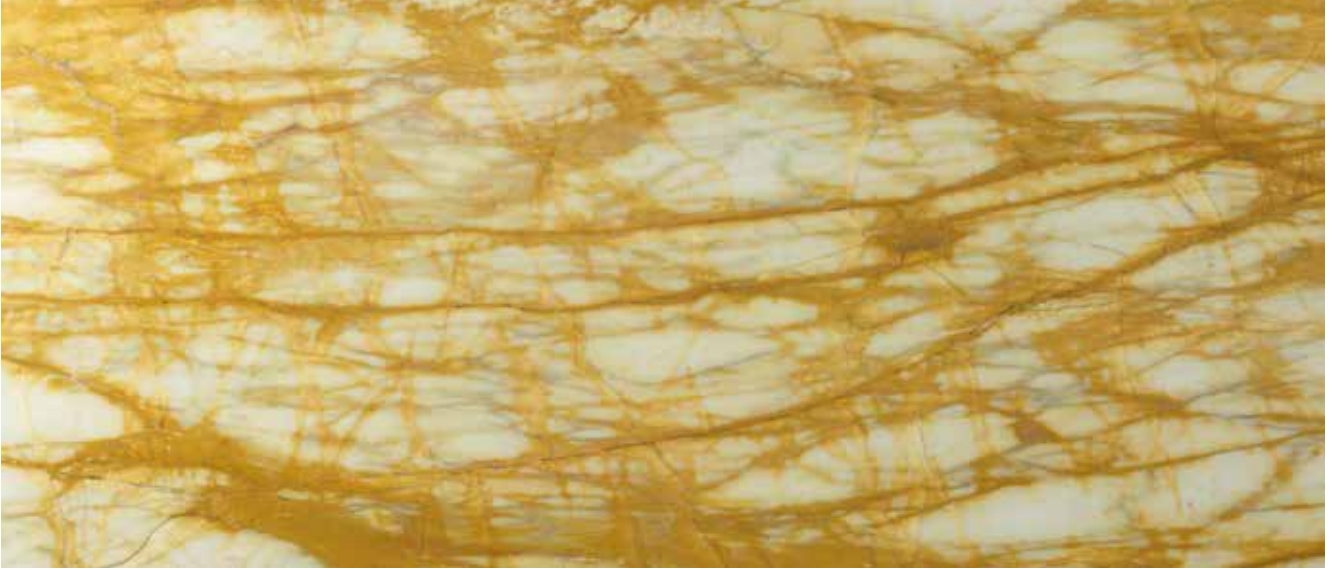

Giallo Conte



Description	Format	Codes	Group	Pcs	m2	Kg
Slab / Tabla / Tranche	2 cm 3/4"	100156919 L108030461	G-289	-	-	-

Butech: Colorstuk Rapid Marfil



Port Monaco



Description	Format	Codes	Group	Pcs	m2	Kg
Slab / Tabla / Tranche	2 cm 3/4"	100157004 L108030441	G-287	-	-	-

Butech: Colorstuk Rapid Antracita

MARBLE / MÁRMOL / MARBRE



Port Cannes



Butech: Colorstuk Rapid Antracita

Description	Format	Codes	Group	Pcs	m2	Kg
Slab / Tabla / Tranche	2 cm 3/4"	100157003 L108030451	G-287	-	-	-



Wall Coverings Port Cannes

HERITAGE



Onix Botafogo

-  GLOSS
-  MODERATE COLOR VARIATION
-  ORIGIN AMERICA
-  INDOOR FLOORING
-  INDOOR WALL COVERING
-  SHOWER WALL COVERINGS
-  COUNTERTOPS
-  LOW TRAFFIC

Description	Format	Codes	Group	Pcs	m2	Kg
Slab / Tabla / Tranche	2 cm 3/4"	100157000 L108030421	G-297	-	-	-

Butech: Colorstuk Rapid Marfil



Onix Lagoa

-  GLOSS
-  MODERATE COLOR VARIATION
-  ORIGIN ASIA
-  INDOOR FLOORING
-  INDOOR WALL COVERING
-  SHOWER WALL COVERINGS
-  COUNTERTOPS
-  LOW TRAFFIC

Description	Format	Codes	Group	Pcs	m2	Kg
Slab / Tabla / Tranche	2 cm 3/4"	100157001 L108030471	G-295	-	-	-

Butech: Colorstuk Rapid Marfil

ONIX



Onix Ipanema

-  MATT
-  MODERATE COLOR VARIATION
-  ORIGIN AMERICA
-  INDOOR FLOORING
-  INDOOR WALL COVERING
-  SHOWER WALL COVERINGS
-  COUNTERTOPS
-  LOW TRAFFIC

Description	Format	Codes	Group	Pcs	m2	Kg
Slab / Tabla / Tranche	2 cm 3/4"	I00157066 L108030531	G-297	-	-	-

Butech: Colorstuk Rapid Marfil



Floor Coverings Onix Ipanema / Wall Coverings Onix Ipanema

HERITAGE



Onix Etnia

-  GLOSS
-  MODERATE COLOR VARIATION
-  ORIGIN ASIA
-  INDOOR FLOORING
-  INDOOR WALL COVERING
-  SHOWER WALL COVERINGS
-  COUNTERTOPS
-  LOW TRAFFIC

Description	Format	Codes	Group	Pcs	m2	Kg
Slab / Tabla / Tranche	2 cm 3/4"	100157064 L108030571	G-297	-	-	-

Butech: Colorstuk Rapid Marfil

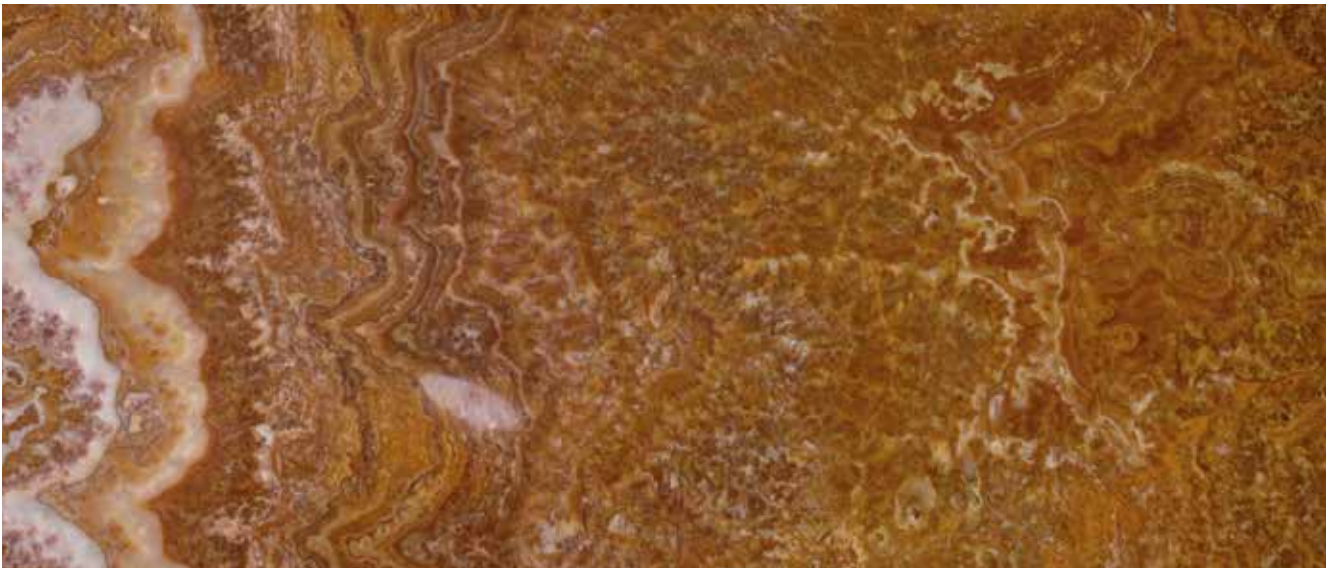

Onix Lava

-  GLOSS
-  MODERATE COLOR VARIATION
-  ORIGIN ASIA
-  INDOOR FLOORING
-  INDOOR WALL COVERING
-  SHOWER WALL COVERINGS
-  COUNTERTOPS
-  LOW TRAFFIC

Description	Format	Codes	Group	Pcs	m2	Kg
Slab / Tabla / Tranche	2 cm 3/4"	100157067 L108030561	G-293	-	-	-

Butech: Colorstuk Rapid Marron

ONIX

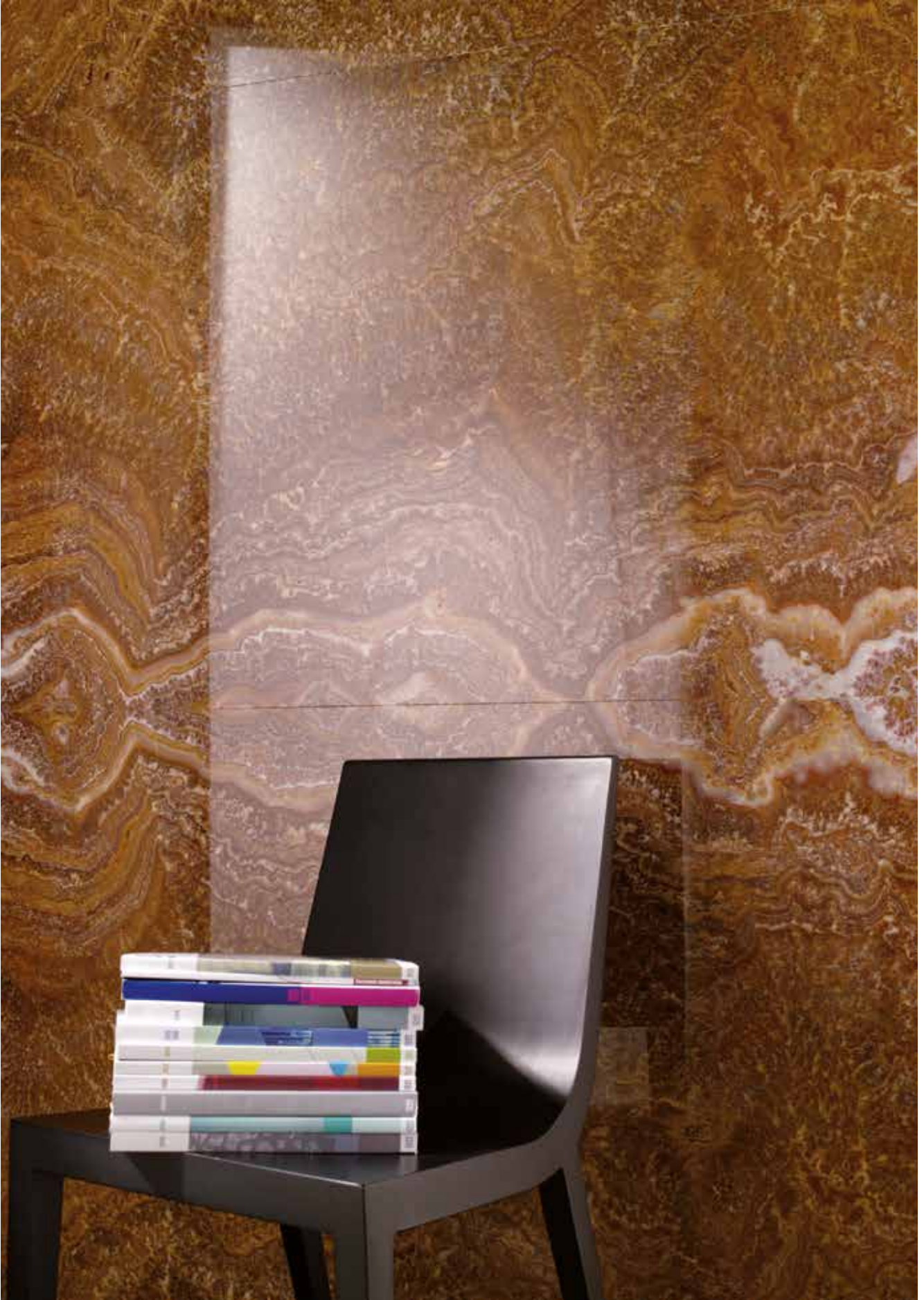

Wall Coverings Onix Lava



Wall Coverings DQS White

DQS



Black
Grey
White

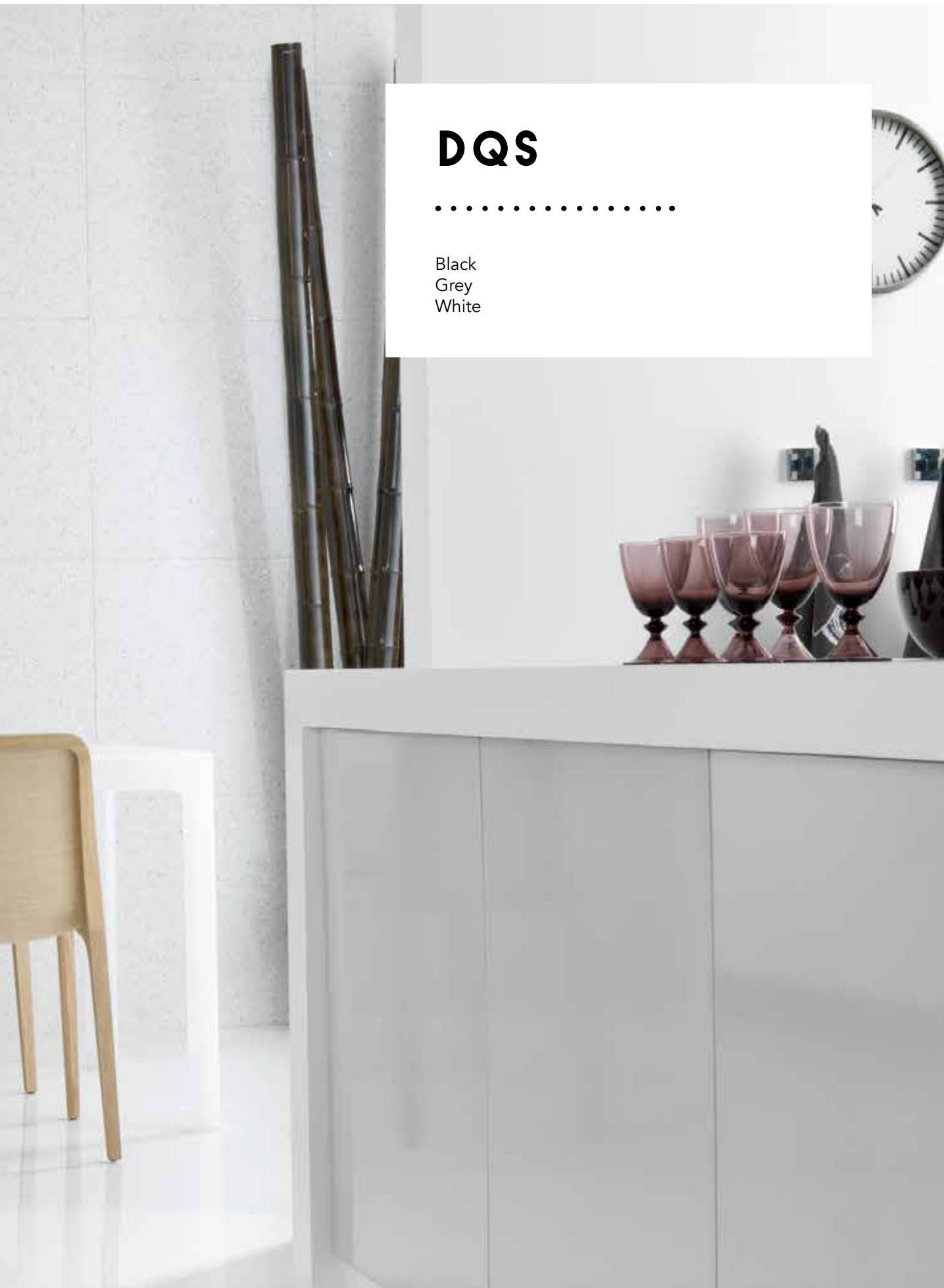

DQS



DQS Black



Description	Format	Codes	Group	Pcs	m2	Kg
DQS Black	60x60x1 cm 23 5/8"x23 5/8"x3/8"	100096053 L107000471	G-276	3 x Cj 96 x Pal	1,08 x Cj 34,56 x Pal	27,56 x Cj 881,95 x Pal

Butech: Colorstuk 0-4 Negro + Ci-Stuk

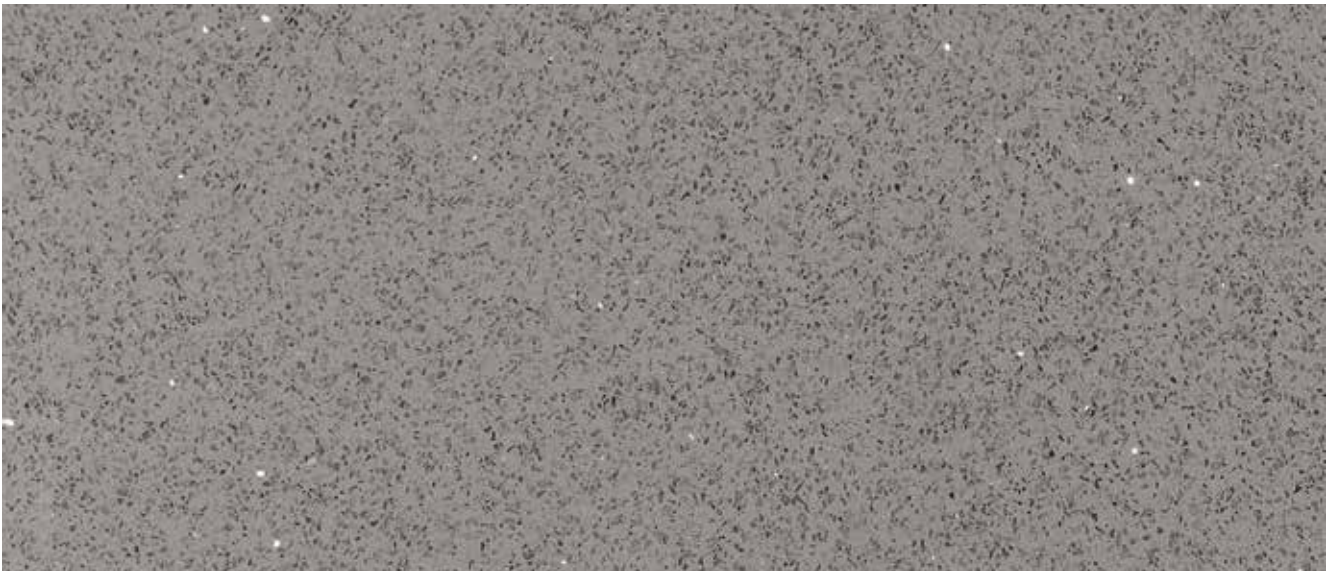

DQS Grey



Description	Format	Codes	Group	Pcs	m2	Kg
DQS Grey	60x60x1 cm 23 5/8"x23 5/8"x3/8"	100096055 L107000491	G-276	3 x Cj 96 x Pal	1,08 x Cj 34,56 x Pal	27,56 x Cj 881,95 x Pal

Butech: Colorstuk 0-4 Cemento + Ci-Stuk

DQS



DQS White



















Description	Format	Codes	Group	Pcs	m2	Kg
DQS White	60x60x1 cm 23 5/8" x 23 5/8" x 3/8"	I00096059 L107000531	G-276	3 x Cj 96 x Pal	1,08 x Cj 34,56 x Pal	27,56 x Cj 881,95 x Pal

Butech: Colorstuk 0-4 Blanco + CI-Stuk

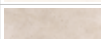

Floor Coverings DQS Grey

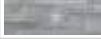
PRODUCT RANGE / GAMA DE PRODUCTO / GAMME DE PRODUIT

		Polished Pulido Polie	Classico	Home	Sand Home	Tumbled Anticato Anticato	Flamed Home	Natural	Natural Home
Marble						●			
		●	●						
		●	●		●				
					●				
		●	●						
		●	●						
		●	●			●			
		●			●				
		●	●						
		●	●						
		●	●						
		●	●		●				
		●	●						
Travertine			●			●			
						●			
			●						
			●						
Quartzite				●					
							●		
				●	●				
Limestone			●						
			●						
						●			
						●			
			●						
		●							
									
									
									
									
									
									
Sand.			●						
			●						
Slates								●	
				●					
								●	
		●							●
		●							●
									●
								●	

CLEANING AND MAINTENANCE / PRODUCTOS DE LIMPIEZA Y MANTENIMIENTO / NETTOYAGE ET ENTRETIEN



Concentrated neutral detergent ideal for washing after laying the natural stone paving. / Detergente neutro concentrado ideal para el lavado después de la colocación de los pavimentos de piedra natural. / Détergent neutre concentré idéal pour le lavage après la pose des revêtements en pierre naturelle.

FILA CLEANER IL

100093624 - L180300233 - G-134

Dilution / Dilución / Diluer 1:200
One litre covers / Rendimiento / Rendement de 1500 m²/L



Descaler for removing grout residue and buildingsite dirt. / Desincrustante que elimina las incrustaciones producidas por la colocación y la suciedad de obra. / Désincrustant qui élimine les incrustations issues de la pose et de la saleté du chantier.

FILA DETERDEK IL

100086918 - L180300226 - G-134

Dilution / Dilución / Diluer 1:5 - 1:10
One litre covers / Rendimiento / Rendement de 20-35 m²/L



Cleaner, stain remover and wax stripper ideal for basic cleaning of acid-sensitive stone paving. / Detergente, quitamanchas y decapante ideal para la limpieza inicial de pavimentos de piedra no resistente a los ácidos. / Détergente anti-taches et décapant idéal pour le nettoyage initial de revêtements en pierre non résistants aux acides.

FILA PS87 IL

100097854 - L180300237 - G-156

Dilution / Dilución / Diluer 1:20
One litre covers / Rendimiento / Rendement de 200 m²/L



Wax with matt finish for paving that makes cleaning and standard maintenance easier. / Cera efecto mate para pavimentos que facilita la limpieza y el mantenimiento ordinario. / Cire effet mat pour revêtements qui facilite le nettoyage et l'entretien ordinaire.

FILA MATT IL

100086923 - L180300230 - G-156

Use without diluting / Usar sin diluir / Utiliser sans diluer
One litre covers / Rendimiento / Rendement de 20 m²/L



Glossy-look self-polishing wax for paving that makes cleaning and standard maintenance easier. / Cera auto abrillantadora efecto brillante para pavimentos que facilita la limpieza y el mantenimiento ordinario. / Cire auto-lustrante effet brillant pour revêtements qui facilite le nettoyage et l'entretien ordinaire.

FILA LONGLIFE IL

100086922 - L180300229 - G-156

Use without diluting / Usar sin diluir / Utiliser sans diluer
One litre covers / Rendimiento / Rendement de 30-40 m²/L



Water-based waterrepellent protection that prevents efflorescence, ageing and decomposition of the product. / Hidrófugo antisalitre base acuosa que evita el envejecimiento y la descomposición del material. / Hydrofuge anti-salpêtre à base aqueuse qui évite le vieillissement et la décomposition du matériau.

FILA HP98 IL

100086919 - L180300227 - G-156

Use without diluting / Usar sin diluir / Utiliser sans diluer
One litre covers / Rendimiento / Rendement de 10-20 m²/L



Stain protection that does not alter original tone, texture or colour of the product. / Protector anti manchas que protege sin cambiarle el tono ni la textura, ni el color del material. / Protecteur anti-taches qui protège sans modifier le ton, la texture ou la couleur du matériau.

FILA FOB IL

100086920 - L180300231 - G-163

Use without diluting / Usar sin diluir / Utiliser sans diluer
One litre covers / Rendimiento / Rendement de 10-20 m²/L



Anti-ageing water-repellent protection for interior and exterior surfaces. / Hidrófugo anti-envejecimiento para interiores y exteriores. / Hydrofuge anti-vieillesissement pour intérieurs et extérieurs.

FILA HYDROREP IL

100095177 - L180001173 - G-156

Use without diluting / Usar sin diluir / Utiliser sans diluer
One litre covers / Rendimiento / Rendement de 10-20 m²/L



Colour-enhancing protection for all types of polished, honed, rough and tumbled natural stone. / Protector reavivante que exalta el color original de todo tipo de piedras naturales, tanto pulida como apomazada, envejecida, abujardada, etc. / Protecteur ravivant qui rehausse la couleur d'origine de tout type de pierres naturelles, qu'elles soient polies ou poncées, vieilles, bouchardées, etc..

FILA STONE PLUS IL

100086921 - L180300228 - G-163

Use without diluting / Usar sin diluir / Utiliser sans diluer
One litre covers / Rendimiento / Rendement de 15-50 m²/L



Pleasant wet-look glossy protection. / Protector que proporciona un agradable efecto mojado con brillo. / Protecteur qui offre un agréable effet mouillé brillant.

FILA WET IL

100098018 - L180300238 - G-156

Use without diluting / Usar sin diluir / Utiliser sans diluer
One litre covers / Rendimiento / Rendement de 10-20 m²/L



Maintenance kit for the restoration of small marble, travertine and limestone surfaces. / Kit de mantenimiento para la restauración de pequeñas superficies de mármol, travertino y caliza. / Kit d'entretien pour la restauration de petites surfaces en marbre, travertin et calcaire.

HIGH-END BATHS MAINTENANCE KIT / KIT MANTENIMIENTO HIGHEND BATHS / KIT D'ENTRETIEN HIGHEND BATHS

100143706 - L179702365 - G-156

Use without diluting / Usar sin diluir / Utiliser sans diluer

TECHNICAL INFORMATION / INFORMACIÓN TÉCNICA / INFORMATIONS TECHNIQUES

	Resistance to abrasion / Resistencia a la abrasión / Résistance à l'abrasion UNE-EN 14157:2005 (mm)	Determination of the Flexural strength / Módulo a la flexión / Module de flexion UNE-EN 12371:2007 (MPa)	Determination of the frost resistance / Resistencia a la flexión tras 48 ciclos (heladicidad) / Résistance à la flexion après 48 cycles (gélivité) UNE-EN 12371:2002 (MPa)	Determination of the unpolished slip resistance value / Resistencia al deslizamiento sin pulido / Résistance au glissement sans polissage UNE-EN 1341:2002 (USRV)
Marbles / Mármoles / Marbres	< 25.0	> 7.0	> 5.0	> 10
Travertine / Travertinos / Travertins	< 25.0	> 7.0	> 5.0	> 10
Granites / Granitos / Granites	< 17.5	> 8.0	> 7.5	> 55
Limestones / Calizas / Pierres Calcaires	< 25.0	> 7.0	> 5.0	> 15
Slates / Pizarras / Ardoises	< 39.0	> 21.0	> 7.0	> 25
Quartzites / Cuarcitas / Quartzites	< 29.0	> 16.5	> 10.5	> 45

*The technical specification of all the materials are available on request. / *Todos los materiales disponen de su ficha técnica específica bajo solicitud / *Tous les matériaux sont fournis sur demande accompagnés de leur fiche technique.



Wall Coverings Globe Stick Mix Nepal Bhutan

TECHNICAL STEPS / PELDAÑOS TÉCNICOS / NEZ DE MARCHE TECHNIQUE

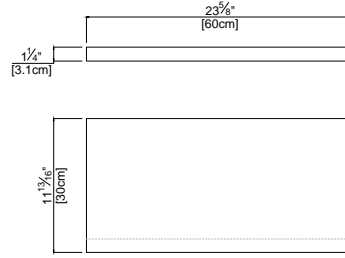

Technical Step / Peldaño Técnico / Nez de Marche Technique

Descripción	Formato	Códigos	Grupo	Pz	M2	Kg
Ptec Arctic White Pulido BPT	30x60x1.5 cm 11 3/4"x23 5/8"x5/8"	100165186 L112996161	G-163	2 x Cj 88 x Pal	0,36 x Cj 15,84 x Pal	15,97 x Cj 702,86 x Pal
Ptec Persian White Classico	30x60x1.5 cm 11 3/4"x23 5/8"x5/8"	100165176 L112995811	G-163	2 x Cj 88 x Pal	0,36 x Cj 15,84 x Pal	15,60 x Cj 686,22 x Pal
Ptec Persian White Pulido	30x60x1.5 cm 11 3/4"x23 5/8"x5/8"	100165194 L112996031	G-163	2 x Cj 88 x Pal	0,36 x Cj 15,84 x Pal	15,60 x Cj 686,22 x Pal
Ptec Blanco Andes Classico	30x60x1 cm 11 3/4"x23 5/8"x3/8"	100165177 L112995971	G-163	2 x Cj 88 x Pal	0,36 x Cj 15,84 x Pal	9,65 x Cj 424,60 x Pal
Ptec Blanco Andes Pulido	30x60x1 cm 11 3/4"x23 5/8"x3/8"	100165196 L112996181	G-163	2 x Cj 88 x Pal	0,36 x Cj 15,84 x Pal	9,65 x Cj 424,60 x Pal
Ptec Moka Classico	30x60x1.2 cm 11 3/4"x23 5/8"x1/2"	100165201 L107601461	G-163	2 x Cj 88 x Pal	0,36 x Cj 15,84 x Pal	10,52 x Cj 462,70 x Pal
Ptec Nairobi Crema Classico	30x60x1.2 cm 11 3/4"x23 5/8"x1/2"	100165175 L112996151	G-163	2 x Cj 88 x Pal	0,36 x Cj 15,84 x Pal	12,11 x Cj 532,84 x Pal
Ptec Nairobi Crema Pulido	30x60x1.2 cm 11 3/4"x23 5/8"x1/2"	100165202 L112996001	G-163	2 x Cj 88 x Pal	0,36 x Cj 15,84 x Pal	12,11 x Cj 532,84 x Pal
Ptec Silk Wood Classico	30x60x1.2 cm 11 3/4"x23 5/8"x1/2"	100165185 L112996081	G-163	2 x Cj 88 x Pal	0,36 x Cj 15,84 x Pal	11,83 x Cj 520,61 x Pal
Ptec Silver Wood Classico	30x60x1.2 cm 11 3/4"x23 5/8"x1/2"	100165195 L112996111	G-163	2 x Cj 88 x Pal	0,36 x Cj 15,84 x Pal	10,73 x Cj 471,94 x Pal
Ptec Ottawa Pulido	30x60x1.2 cm 11 3/4"x23 5/8"x5/8"	100174546 L112996391	G-163	2 x Cj 88 x Pal	0,36 x Cj 15,84 x Pal	15,97 x Cj 702,86 x Pal
Ptec Capuccino Pulido	30x60x1.2 cm 11 3/4"x23 5/8"x1/2"	100165187 L112995911	G-163	2 x Cj 88 x Pal	0,36 x Cj 15,84 x Pal	12,22 x Cj 537,50 x Pal
Ptec Habana Brown Classico	30x60x1.2 cm 11 3/4"x23 5/8"x1/2"	100165169 L112996141	G-163	2 x Cj 88 x Pal	0,36 x Cj 15,84 x Pal	11,59 x Cj 509,96 x Pal
Ptec Habana Brown Pulido	30x60x1.2 cm 11 3/4"x23 5/8"x1/2"	100165170 L112996021	G-163	2 x Cj 88 x Pal	0,36 x Cj 15,84 x Pal	11,59 x Cj 509,96 x Pal
Ptec Habana Grey Classico	30x60x1.2 cm 11 3/4"x23 5/8"x5/8"	100174544 L112996331	G-163	2 x Cj 88 x Pal	0,36 x Cj 15,84 x Pal	11,59 x Cj 509,96 x Pal
Ptec Habana Grey Pulido	30x60x1.2 cm 11 3/4"x23 5/8"x5/8"	100174545 L112996341	G-163	2 x Cj 88 x Pal	0,36 x Cj 15,84 x Pal	14,59 x Cj 509,96 x Pal
Ptec Habana Dark Classico	30x60x1.5 cm 11 3/4"x23 5/8"x5/8"	100171874 L112996281	G-163	2 x Cj 88 x Pal	0,36 x Cj 15,84 x Pal	14,59 x Cj 642,14 x Pal
Ptec Habana Dark Pulido	30x60x1.5 cm 11 3/4"x23 5/8"x5/8"	100165129 L112995891	G-163	2 x Cj 88 x Pal	0,36 x Cj 15,84 x Pal	14,59 x Cj 642,14 x Pal

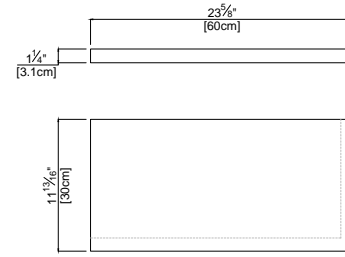

Technical Step Right Corner / Peldaño Técnico Esquina Derecha / Nez de Marche Technique Coin Droit

Descripción	Formato	Códigos	Grupo	Pz	M2	Kg
Ptec D Arctic White Pulido	30x60x1.5 cm 11 3/4"x23 5/8"x5/8"	100165203 L112996061	G-166	1 x Cj 44 x Pal	0,18 x Cj 7,92 x Pal	7,99 x Cj 351,43 x Pal
Ptec D Persian White Classico	30x60x1.5 cm 11 3/4"x23 5/8"x5/8"	100165128 L112995801	G-166	1 x Cj 44 x Pal	0,18 x Cj 7,92 x Pal	7,80 x Cj 343,11
Ptec D Persian White Pulido	30x60x1.5 cm 11 3/4"x23 5/8"x5/8"	100165168 L112996121	G-166	1 x Cj 44 x Pal	0,18 x Cj 7,92 x Pal	7,80 x Cj 343,11 x Pal
Ptec D Blanco Andes Classico	30x60x1 cm 11 3/4"x23 5/8"x3/8"	100165164 L112996011	G-166	1 x Cj 44 x Pal	0,18 x Cj 7,92 x Pal	4,83 x Cj 212,30 x Pal
Ptec D Blanco Andes Pulido	30x60x1 cm 11 3/4"x23 5/8"x3/8"	100165124 L112995851	G-166	1 x Cj 44 x Pal	0,18 x Cj 7,92 x Pal	4,83 x Cj 212,30 x Pal
Ptec D Moka Classico	30x60x1.2 cm 11 3/4"x23 5/8"x1/2"	100165167 L107601451	G-166	1 x Cj 44 x Pal	0,18 x Cj 7,92 x Pal	5,26 x Cj 231,35 x Pal
Ptec D Nairobi Crema Classico	30x60x1.2 cm 11 3/4"x23 5/8"x1/2"	100165126 L112996171	G-166	1 x Cj 44 x Pal	0,18 x Cj 7,92 x Pal	6,06 x Cj 266,42 x Pal
Ptec D Nairobi Crema Pulido	30x60x1.2 cm 11 3/4"x23 5/8"x1/2"	100165127 L112995981	G-166	1 x Cj 44 x Pal	0,18 x Cj 7,92 x Pal	6,06 x Cj 266,42 x Pal
Ptec D Silk Wood Classico	30x60x1.2 cm 11 3/4"x23 5/8"x1/2"	100165159 L112995931	G-166	1 x Cj 44 x Pal	0,18 x Cj 7,92 x Pal	5,92 x Cj 260,30 x Pal
Ptec D Silver Wood Classico	30x60x1.2 cm 11 3/4"x23 5/8"x1/2"	100165138 L112995901	G-166	1 x Cj 44 x Pal	0,18 x Cj 7,92 x Pal	5,36 x Cj 235,97 x Pal
Ptec D Ottawa Pulido	30x60x1.2 cm 11 3/4"x23 5/8"x5/8"	100174528 L112996411	G-166	1 x Cj 44 x Pal	0,18 x Cj 7,92 x Pal	7,30 x Cj 321,07 x Pal
Ptec D Capuccino Pulido	30x60x1.2 cm 11 3/4"x23 5/8"x1/2"	100165165 L112995861	G-166	1 x Cj 44 x Pal	0,18 x Cj 7,92 x Pal	6,11 x Cj 268,75 x Pal
Ptec D Habana Brown Classico	30x60x1.2 cm 11 3/4"x23 5/8"x1/2"	100165125 L112995941	G-166	1 x Cj 44 x Pal	0,18 x Cj 7,92 x Pal	5,80 x Cj 254,98 x Pal
Ptec D Habana Brown Pulido	30x60x1.2 cm 11 3/4"x23 5/8"x1/2"	100165166 L112995951	G-166	1 x Cj 44 x Pal	0,18 x Cj 7,92 x Pal	5,80 x Cj 254,98 x Pal
Ptec D Habana Grey Classico	30x60x1.2 cm 11 3/4"x23 5/8"x5/8"	100174518 L112996321	G-166	1 x Cj 44 x Pal	0,18 x Cj 7,92 x Pal	5,80 x Cj 254,98 x Pal
Ptec D Habana Grey Pulido	30x60x1.2 cm 11 3/4"x23 5/8"x5/8"	100174543 L112996311	G-166	1 x Cj 44 x Pal	0,18 x Cj 7,92 x Pal	5,80 x Cj 254,98 x Pal
Ptec D Habana Dark Classico	30x60x1.5 cm 11 3/4"x23 5/8"x5/8"	100171873 L112996271	G-166	1 x Cj 44 x Pal	0,18 x Cj 7,92 x Pal	7,30 x Cj 321,07 x Pal
Ptec D Habana Dark Pulido	30x60x1.5 cm 11 3/4"x23 5/8"x5/8"	100165136 L112995921	G-163	1 x Cj 44 x Pal	0,18 x Cj 7,92 x Pal	7,30 x Cj 321,07 x Pal

TECHNICAL STEPS / PELDAÑOS TÉCNICOS / NEZ DE MARCHE TECHNIQUE

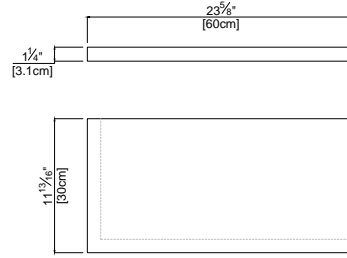

Technical Step Left Corner / Peldaño Técnico Esquina Izquierda / Nez de Marche Technique Coin Gauche

Descripción	Formato	Códigos	Grupo	Pz	M2	Kg
Ptec I Arctic White Pulido	30x60x1,5 cm 11 3/4"x23 5/8"x5/8"	100165139 L112996131	G-166	1 x Cj 44 x Pal	0,18 x Cj 7,92 x Pal	7,99 x Cj 351,43 x Pal
Ptec I Persian White Classico	30x60x1,5 cm 11 3/4"x23 5/8"x5/8"	100165193 L112995821	G-166	1 x Cj 44 x Pal	0,18 x Cj 7,92 x Pal	7,80 x Cj 343,11
Ptec I Persian White Pulido	30x60x1,5 cm 11 3/4"x23 5/8"x5/8"	100165183 L112995991	G-166	1 x Cj 44 x Pal	0,18 x Cj 7,92 x Pal	7,80 x Cj 343,11 x Pal
Ptec I Blanco Andes Classico	30x60x1 cm 11 3/4"x23 5/8"x3/8"	100165180 L112996211	G-166	1 x Cj 44 x Pal	0,18 x Cj 7,92 x Pal	4,83 x Cj 212,30 x Pal
Ptec I Blanco Andes Pulido	30x60x1 cm 11 3/4"x23 5/8"x3/8"	100165181 L112995871	G-166	1 x Cj 44 x Pal	0,18 x Cj 7,92 x Pal	4,83 x Cj 212,30 x Pal
Ptec I Moka Classico	30x60x1,2 cm 11 3/4"x23 5/8"x1/2"	100165191 L112996091	G-166	1 x Cj 44 x Pal	0,18 x Cj 7,92 x Pal	5,26 x Cj 231,35 x Pal
Ptec I Nairobi Crema Classico	30x60x1,2 cm 11 3/4"x23 5/8"x1/2"	100165192 L112996041	G-166	1 x Cj 44 x Pal	0,18 x Cj 7,92 x Pal	6,06 x Cj 266,42 x Pal
Ptec I Nairobi Crema Pulido	30x60x1,2 cm 11 3/4"x23 5/8"x1/2"	100165200 L112996191	G-166	1 x Cj 44 x Pal	0,18 x Cj 7,92 x Pal	6,06 x Cj 266,42 x Pal
Ptec I Silk Wood Classico	30x60x1,2 cm 11 3/4"x23 5/8"x1/2"	100165174 L112996051	G-166	1 x Cj 44 x Pal	0,18 x Cj 7,92 x Pal	5,92 x Cj 260,30 x Pal
Ptec I Silver Wood Classico	30x60x1,2 cm 11 3/4"x23 5/8"x1/2"	100165184 L112996101	G-166	1 x Cj 44 x Pal	0,18 x Cj 7,92 x Pal	5,36 x Cj 235,97 x Pal
Ptec I Ottawa Pulido	30x60x1,2 cm 11 3/4"x23 5/8"x5/8"	100174519 L112996401	G-166	1 x Cj 44 x Pal	0,18 x Cj 7,92 x Pal	7,30 x Cj 321,07 x Pal
Ptec I Capuccino Pulido	30x60x1,2 cm 11 3/4"x23 5/8"x1/2"	100165171 L112996071	G-166	1 x Cj 44 x Pal	0,18 x Cj 7,92 x Pal	6,11 x Cj 268,75 x Pal
Ptec I Habana Brown Classico	30x60x1,2 cm 11 3/4"x23 5/8"x1/2"	100165182 L112995881	G-166	1 x Cj 44 x Pal	0,18 x Cj 7,92 x Pal	5,80 x Cj 254,98 x Pal
Ptec I Habana Brown Pulido	30x60x1,2 cm 11 3/4"x23 5/8"x1/2"	100165173 L112995961	G-166	1 x Cj 44 x Pal	0,18 x Cj 7,92 x Pal	5,80 x Cj 254,98 x Pal
Ptec I Habana Grey Classico	30x60x1,2 cm 11 3/4"x23 5/8"x5/8"	100174529 L112996361	G-166	1 x Cj 44 x Pal	0,18 x Cj 7,92 x Pal	5,80 x Cj 254,98 x Pal
Ptec I Habana Grey Pulido	30x60x1,2 cm 11 3/4"x23 5/8"x5/8"	100174534 L112996351	G-166	1 x Cj 44 x Pal	0,18 x Cj 7,92 x Pal	5,80 x Cj 254,98 x Pal
Ptec I Habana Dark Classico	30x60x1,5 cm 11 3/4"x23 5/8"x5/8"	100171868 L112996291	G-166	1 x Cj 44 x Pal	0,18 x Cj 7,92 x Pal	7,30 x Cj 321,07 x Pal
Ptec I Habana Dark Pulido	30x60x1,5 cm 11 3/4"x23 5/8"x5/8"	100165190 L112996201	G-166	1 x Cj 44 x Pal	0,18 x Cj 7,92 x Pal	7,30 x Cj 321,07 x Pal



STAIRS / ESCALERAS / ESCALIERS



Floor Coverings Crema Grecia Classico

STAIRS / ESCALERAS / ESCALIERS

TREAD RISER - TREAD RISER ON TEMPLATE /
 HUELLA TABICA - HUELLA TABICA SOBRE PLAN-
 TILLA / MARCHE CONTRE MARCHE - MARCHE
 CONTREMARCHE SUR GABARIT

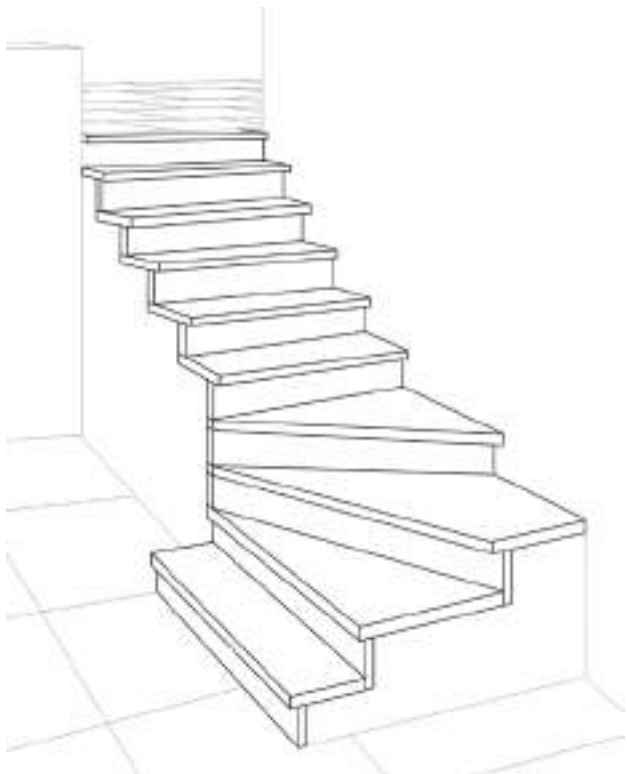

TREAD RISER - CIRCULAR TREAD / HUELLA TABI-
 CA - HUELLA CIRCULAR / MARCHE CONTRE
 MARCHE - MARCHE ARRONDIE



TREAD ONLY / SÓLO HUELLA / MARCHE UNIQUEMENT

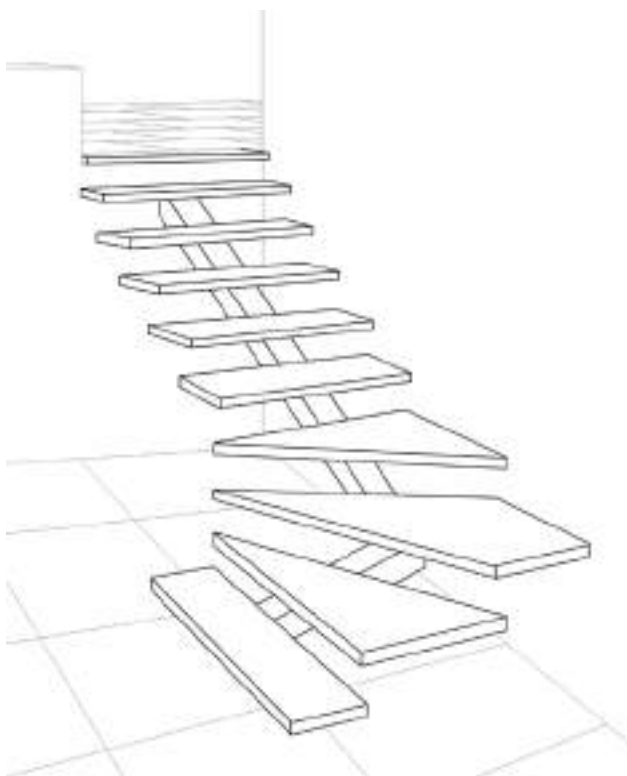

FINISHES / ACABADOS / FINITIONS

EDGES / CANTOS / BORDS

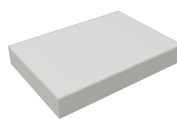

Straight / Recto / Doit

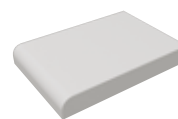

1/4 Round Edge / 1/4
 Canto Redondo / 1/4
 Bord Rond

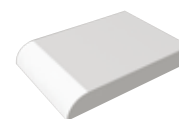

1/2 Round Edge / 1/2
 Canto Redondeado / 1/2
 Bord Arrondi

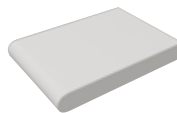

Round edge / Canto
 Redondeado / Bord Arrondi

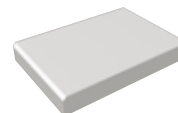

Bevelled / Biselado /
 Biseauté

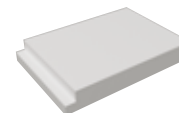

Pilaster Edge / Canto
 Pilastra / Bord pilastre

CUTS / CORTES / DÉCOUPES

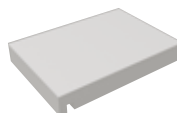

Run-off / Goterón / Larmier

INSTALLATION / INSTALACIÓN / INSTALLATION

I. SUBSTRATE OR LAYING BASE

I. SOPORTE O FONDO DE COLOCACIÓN

I. UPPORT OU FOND DE POSE

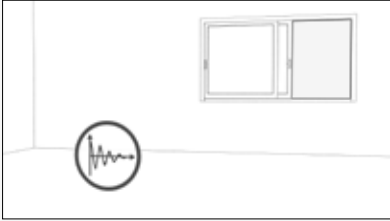

It must be dimensionally stable and non-deformable, having undergone all the possible contractions from drying.

Debe ser dimensionalmente estable y no deformable, habiendo completado las posibles contracciones por secado.

Il doit être non déformable, avec des dimensions stables, les éventuelles contractions ayant été complétées par séchage.



It shall be perfectly free from dust, grease, or any substance that can compromise the adherence.

Estará perfectamente limpio de polvo, grasas o de cualquier sustancia que pueda comprometer la adhesión.

Il doit être exempt de poussière, de graisse ou de toute autre substance pouvant compromettre l'adhésion.

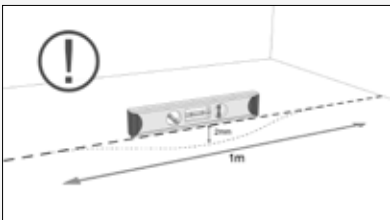

It shall not have defects in its flatness larger than 2 mm, checked using a 2 m ruler.

No debe presentar defectos de planaridad superiores a 2 mm, comprobado con una regla de 2 m.

Contrôler avec une règle de 2 m les défauts de planéité, qui ne doivent pas être supérieurs à 2 mm.

2. INSTALLING THE PIECES

2. COLOCACIÓN DE LAS PIEZAS

2. POSE DES PIÈCES

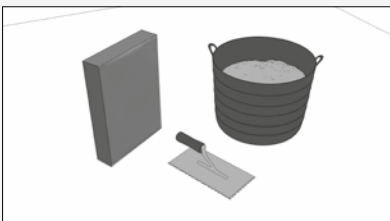

Prepare the adhesive following the manufacturer's instructions; in our case we recommend ONE-FLEX. We recommend

Butech's SUPER-ONE as adhesive for our white Marbles.

Se prepara el adhesivo siguiendo las instrucciones del fabricante, en nuestro caso recomendamos ONE-FLEX. Para nuestros Mármoles blancos recomendamos como adhesivo SUPER-ONE de Butech.

Préparer la colle en fonction des indications du fabricant. Nous recommandons l'utilisation de ONE-FLEX. Pour nos marbres blancs, nous recommandons le mortier colle SUPER-ONE de Butech.

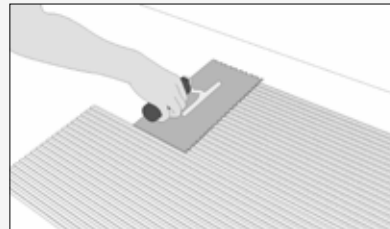

The adhesive is applied with an adequate-sized notched trowel depending on the format of the piece to install.

Se aplica el adhesivo con una llana dentada del tamaño adecuado según el formato de la pieza a colocar.

Étaler la colle avec une taloche crantée dont les dimensions sont adaptées au format de la pièce à poser.

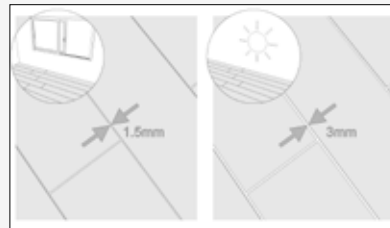

It is very important not to install the tiles in contact with each other. We shall leave joints of a size that is adequate and proportional to the dimension of the piece. We recommend a minimum joint of 1.5 mm indoors, and a minimum joint of 3 mm outdoors.

Es muy importante no colocar las baldosas en contacto entre sí. Debemos dejar juntas del tamaño adecuado y proporcional a la dimensión de la pieza. Para interiores se recomienda una junta mínima de 1.5 mm y para exteriores una junta mínima de 3 mm.

Lors de la pose, il est important d'éviter le contact entre les dalles. Laisser des joints dont la taille doit être adaptée et proportionnelle à celle de la pièce. Le joint minimal recommandé est de 1,5 mm pour les intérieurs et de 3 mm pour les extérieurs.

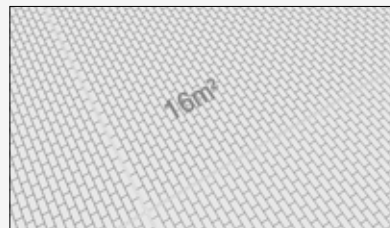

Both perimeter and expansion joints shall be 10 mm wide, and we shall not leave a surface area greater than 16 m² or 8 m without an expansion joint.

Las juntas tanto perimetrales como de dilatación serán de 10 mm y no dejar una superficie superior a 16 m² ó 8 m lineales sin junta de dilatación.

Les joints de périmètre et de dilatation doivent être de 10 mm. Ne jamais laisser une surface supérieure à 16 m² ou 8 m linéaires sans joint de dilatation.

3. SEALING INSTALLATION JOINTS

3. SELLADO DE JUNTAS DE COLOCACIÓN

3. SCELLEMENT DES JOINTS DE POSE



This process shall be carried out 24 hours after the protection of the stones (step 4).

Este proceso se efectuará después de transcurridas 24 horas tras la protección de las piedras (paso 4).

Cette opération doit être effectuée 24 heures après la protection des pierres (étape 4).

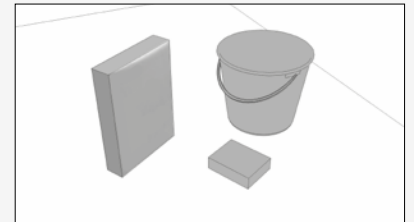

The grouting material is prepared, in our case we recommend COLORSTUK 2-12.

Se prepara el material de rejuntado, en nuestro caso recomendamos COLORSTUK 2-12.

Préparer le matériau de jointoiment. Nous recommandons l'utilisation de COLORSTUK 2-12.

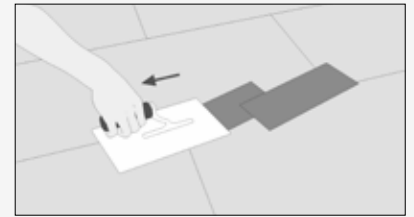

The grouting material is applied with a hard rubber trowel, passing it repeatedly crosswise over the joints.

Se aplica el material de rejuntado mediante llana de goma dura, pasándola repetidamente por las juntas en sentido diagonal.

Appliquer le matériau de jointoiment avec une taloche en caoutchouc dur, en la passant plusieurs fois sur les joints dans le sens diagonal.

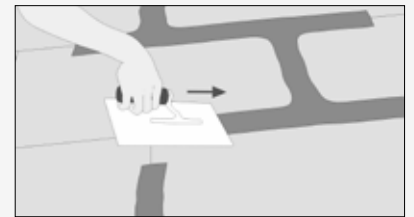

We shall pick up the leftovers with the same trowel.

Los sobrantes los recogeremos con la misma llana.

Récupérer les excédents avec la même taloche.

INSTALLATION / INSTALACIÓN / INSTALLATION



We shall clean the surface with a thin, hard sponge, once the mortar begins to harden.

Limpiaremos la superficie con una esponja fina y dura una vez el mortero comienza a endurecer.

Nettoyer la surface à l'aide d'une éponge fine et dure, une fois que le mortier commence à durcir.



4. PROTECTION OF NATURAL STONE

4. PROTECCION DE LA PIEDRA NATURAL

4. PROTECTION DE LA PIERRE NATURELLE

L'Antic Colonial supplies all of its natural stone products already protected, but in case it is necessary we shall proceed as follows.

L'Antic Colonial ya suministra todos sus productos de piedra natural protegidos, pero en el caso que sea necesario se procederá de la siguiente manera.

L'Antic Colonial livre la totalité de ses produits en pierre naturelle avec une protection, mais en cas de nécessité, ils doivent être protégés de la manière suivante.



Check that the stone is completely clean and dry.

Verificamos que la piedra está totalmente limpia y seca.

Vérifier que la pierre est totalement propre et sèche.



The protector is applied undiluted, using a thin foam roller, applying two crossed layers directly on the pieces. Only one application is required. Allow to dry completely.

Se aplica el protector, sin diluir, utilizando un rodillo de espuma fina, aplicado en dos capas cruzadas directamente sobre las piezas. Solo es necesaria una aplicación. Dejar secar totalmente.

Appliquer le protecteur, sans le diluer, en utilisant un rouleau en mousse fine, en l'étalant en deux couches croisées directement sur les pièces. Seule une application est nécessaire. Laisser sécher complètement.

You can find the detailed up-to-date installation guide by visiting our website www.anticcolonial.com

Puedes revisar estas instrucciones de instalación actualizadas y con mas detalle visitando nuestra pagina web www.anticcolonial.com

Les dernières mises à jour sur les conseils d'installation et des informations complémentaires sont disponibles sur notre site web www.anticcolonial.com



Floor Coverings Capuccino Grey Pulido / Wall Coverings Capuccino Grey Classico, Glaze Micro Brick Grey

INSTALLATION / INSTALACIÓN / INSTALLATION / AIRSLATE

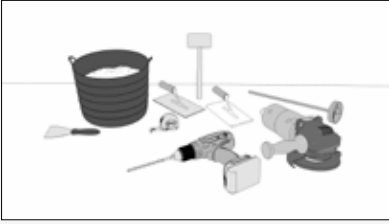

1- Required material for installation: a series of materials and tools are required, such as a notched trowel, a rubber mallet, an agitator, a level, a rubber mallet, a circular saw, meter markers, a spatula and adhesive paste.

1- Material necesario para la instalación, se requiere una serie de materiales y herramientas, tales como una llana dentada, una llana de goma, agitador, nivel, maza de goma, radial, marcadores, metro, espátula y pasta adhesiva.

1- Matériel nécessaire à l'installation : l'installation exige une série de matériaux et d'outils, tels qu'une taloche crantée, une taloche en caoutchouc, un agitateur, un niveau, un maillet en caoutchouc, une scie radiale, des marqueurs, un mètre, une spatule et de la pâte adhésive.

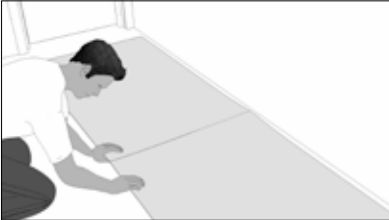

2- Before installing, the floor shall be protected with cardboard or plastic to prevent staining.

2- Antes de la instalación se protegerá el suelo con cartón o plástico para evitar manchas.

2- Avant l'installation, protéger le sol avec du carton ou du plastique pour éviter les taches.

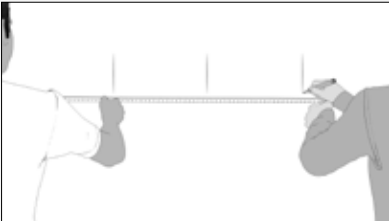

3- Next, knowing the sheet format, we shall mark the width and height measurements shall on the wall, in order to assist with its installation later.

3- A continuación, sabiendo el formato de la lámina, se marcarán las medidas tanto de anchura como de altura en la pared, para ayudar luego a su colocación.

3- En tenant compte du format de la lame, tracer ensuite sur le mur les dimensions de largeur et de hauteur pour faciliter l'installation.



4- For laying the sheet, we recommend you use masking tape, which will have to be stuck to the sheet's edge. This way we will prevent the adhesive to get in the surface when installed, and the excess of adhesive will be easily removable

from the joints between sheets once hammered. Once the sheet has been installed, use a spirit level to check it is leveled.

4- Para la colocación de la lámina, se recomienda usar cinta carroceros que se colocará por la testa de la lámina para evitar que el adhesivo se deposite en la superficie cuando se instala y se quite fácilmente el exceso de adhesivo de las juntas entre láminas una vez maceadas. Una vez colocada inicialmente la lámina, se comprobará con el nivel que haya quedado perfectamente nivelada.

4- Pour la pose de la lame, il est recommandé d'utiliser du ruban de masquage au bord des lames pour éviter que l'adhésif se dépose à la surface lors de l'installation. Après avoir utilisé le maillet, cela permet d'enlever facilement l'excès de colle au niveau des joints entre les lames. Après avoir posé initialement la lame, vérifier à l'aide du niveau qu'elle est parfaitement nivelée.



5- Installation using adhesive paste. You must use a type R2 T two-component adhesive (EPOTECH from Butech recommended) and must mix well before application. Spread an even layer of the adhesive over the whole surface with a trowel. Once the adhesive spread, install the sheet by hand and then use a rubber trowel or metallic hand roller to set it in the right position and to avoid air bubbles.

5- Colocación con pasta adhesiva. Se usará una cola bicomponente tipo R2 T (recomendando EPOTECH de Butech) homogeneizándose bien antes de aplicar. La cola se extenderá de manera uniforme por toda la superficie con la llana para la posterior colocación de la lámina. Una vez aplicada la cola, se colocará la lámina con la mano y después se usa la llana de goma o rodillo metálico para fijarla correctamente y evitar bolsas de aire.

5- Pose avec de la pâte adhésive. Utiliser une colle bi-composant de type R2 T (nous recommandons EPOTECH de Butech) et bien l'homogénéiser avec l'application. À l'aide de la taloche, étaler la colle uniformément sur toute la surface avant la pose de la lame. Après avoir appliqué la colle, positionner la lame manuellement puis utiliser la taloche en caoutchouc ou le rouleau métallique pour la fixer correctement et éviter les poches d'air.



6- Repeat the process with the rest of the sheets until they are all installed. You do not need to leave any joints, as the sheets are installed side by side. If you wish to seal the joints, we recommend to protect the sides of the edges with masking tape to avoid to stain the material with the joint sealer.

6- Repitiéndose el proceso con las demás láminas hasta su completa colocación. En su colocación no es necesario dejar juntas, se colocará a testa una lámina con otra. Si se desea sellar las juntas, recomendamos proteger los laterales de las juntas

con cinta de carroceros para evitar manchar el material con el producto con que se sella la junta.

6- Répéter ce processus avec les autres lames jusqu'à l'installation complète. Lors de la pose, il n'est pas nécessaire de laisser des joints. Poser les lames sans interruption entre l'une et l'autre. Si vous souhaitez sceller les joints, il est recommandé de les protéger sur les côtés avec du ruban de masquage, afin d'éviter de tacher le matériel avec le produit de scellement des joints.



7- Once the sheet has been installed, it is very important to take out excess of adhesive right away to avoid leaving debris in the surface. Clean thoroughly with a damp cloth or tissue and allow to dry.

7- Una vez colocada la lámina, es muy importante retirar los excesos de adhesivo de forma inmediata para evitar que pueda dejar restos en la superficie. Limpiar intensamente con un trapo o papel húmedo y dejar secar.

7- Après la pose de la lame, il est très important de retirer immédiatement les excès de colle pour éviter de laisser des traces sur la surface. Nettoyer à fond à l'aide d'un chiffon ou de papier humide, puis laisser sécher.



8- The material is supplied protected, so there is no need to apply any water repellent after installation. In case you wish to apply a new protection layer, we recommend the use of a neutral protector like FILA FOB. Once the protective fluid applied, take out the excess with a cloth or tissue so that the application is even.

8- El material se suministra protegido, con lo que no es necesario aplicar ningún hidrofugante tras la instalación del mismo. En el caso que se quiera realizar una nueva aplicación de protector, se recomienda el uso de un protector neutro tipo FILA FOB. Una vez aplicado el líquido protector, retirar el exceso con un trapo o papel para que la aplicación quede homogénea.

8- Le matériel est fourni avec une protection. Il n'est donc pas nécessaire d'appliquer un produit hydrofuge après son installation. Si vous souhaitez effectuer une nouvelle application de protecteur, il est recommandé d'utiliser un protecteur neutre tel que FILA FOB. Après avoir appliqué le liquide protecteur, enlever l'excès à l'aide d'un chiffon ou d'un papier pour que l'application soit homogène.

You can find the detailed up-to-date installation guide by visiting our website www.anticcolonial.com

Puedes revisar estas instrucciones de instalación actualizadas y con mas detalle visitando nuestra pagina web www.anticcolonial.com

Les dernières mises à jour sur les conseils d'installation et des informations complémentaires sont disponibles sur notre site web www.anticcolonial.com

INSTALLATION / INSTALACIÓN / INSTALLATION / DQS



Substrates shall be completely dry (residual moisture shall not exceed 2.5%) stable, solid, resistant to compression, sufficiently leveled, and free of dust, grease, wax, paint, stripping agents, and anything else that could hinder adherence.

Los soportes deben estar totalmente secos (la humedad residual no debe ser superior al 2,5 %), estables, sólidos, resistentes a la compresión, suficientemente nivelados y libres de polvo, grasa, cera, pintura, agentes decapantes y cualquier otra cosa que pudiera entorpecer la adherencia.

Les supports doivent être complètement secs (l'humidité résiduelle ne doit pas dépasser 2,5 %), stables, solides, résistants à la compression, suffisamment nivelés et libres de poussière, de graisses, de cires, de peinture, de décapants et de tout autre élément pouvant empêcher la prise du mortier.

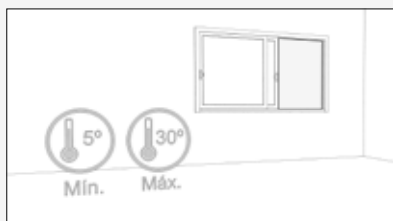

Room temperature shall be between 5° and 30 °C;

La temperatura ambiental debe estar entre +5° y +30° C;

La température ambiante doit être entre +5 °C et +30 °C.

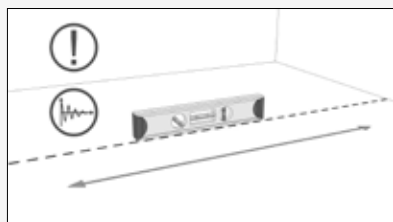

We shall verify that the substrate is vertically aligned, properly leveled, and it shall not have defects in its flatness larger than 2 mm, checked using a 2 m ruler.

Verificaremos que el soporte esté adecuadamente aplomado, nivelado y no debe presentar defectos en su planimetría superiores a 2 mm, comprobados mediante una regla de 2 m.

Il faudra vérifier de même avec une règle de 2 m que le support est bien plombé, nivelé et sans des défauts de planimétrie supérieurs à 2 m.

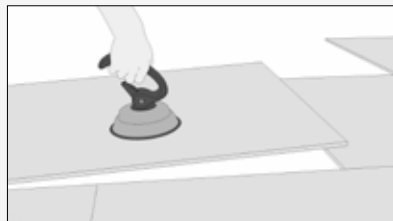

We recommend that large tiles be installed with the help of a suction cup.

Recomendamos que las baldosas de gran tamaño se coloquen con la ayuda de una ventosa.

Pour la pose de carreaux grand format, il est recommandé d'utiliser une ventouse.

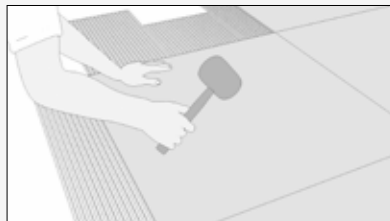

To ensure contact with the substrate, it is advisable to lightly tap the tiles with a rubber mallet, in order to avoid the formation of air bubbles and gaps.

Para asegurar el contacto con el soporte, es aconsejable golpear ligeramente las baldosas con una maza de goma, para evitar la formación de burbujas de aire y espacios vacíos.

Pour assurer un bon contact avec le support, il est recommandé de donner des petits coups sur les carreaux avec un maillet en caoutchouc pour éviter les éventuelles bulles d'air et les espaces libres.



A good tile installation and correct alignment requires using nylon spacers in order to leave open joints.

Una buena colocación y la correcta alineación de las baldosas requieren juntas abiertas mediante el uso de crucetas de nailon.

Pour le bon alignement et la pose correcte des carreaux, il faudra réaliser des joints ouverts à l'aide de croisillons en nylon.

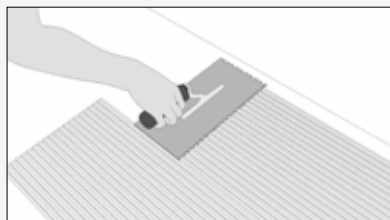

We recommend applying the adhesive SUPER ONE+ UNILAX with a notched trowel, making sure that the amount spread over the substrate covers at least 80% of the DQS tiles.

Recomendamos que se aplique el adhesivo SUPER ONE+ UNILAX con una llana dentada, asegurándose de que la cantidad esparcida sobre el soporte cubra al menos el 80 % de las baldosas de DQS.

Il est recommandé d'appliquer le mortier SUPER ONE+ UNILAX colle à l'aide d'une taloche crantée, en s'assurant que la quantité répartie sur le support couvre au moins 80 % des carreaux de DQS.

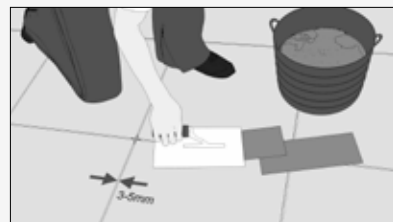

Filling joints: the installation of tiles without joints should be avoided at all costs. The joint width depends on the tile size. (Minimum values of 3-5 mm.). L'Antic Colonial recommends COLORSTUK 0-4 + cl-Stuk from Butech.

Relleno de juntas: debe evitarse a toda costa la colocación de baldosas sin juntas. La anchura de las juntas depende del tamaño de las baldosas. (Valores mínimos de 3 a 5 mm). L'Antic Colonial recomienda el uso de COLORSTUK 0-4 + cl-Stuk de Butech

Remplissage des joints : éviter à tout prix la pose de carreaux sans joints. La largeur des joints dépend de la taille des carreaux. (Valeurs minimales entre 3 et 5 mm). L'Antic Colonial recommande COLORSTUK 0-4 + cl-Stuk de Butech.

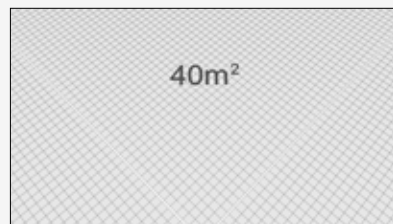

Make sure to leave a 1 cm wide perimeter joint around walls and along floor surface edges with the tiles. 0.5 cm Wide expansion joints should be inserted every 40 m² or every 8 linear meters.

Asegúrese de dejar una junta perimetral de 1 cm de ancho alrededor de las paredes y por los bordes de superficies de suelo con baldosas. Deberían insertarse juntas de dilatación de 0,5 cm de ancho cada 40 m² o cada 8 metros lineales.

Prévoir un joint périmétral de 1 cm de largeur le long des murs et sur les unions des carreaux avec d'autres types de surfaces. Prévoir aussi des joints de dilatation de 0,5 cm de largeur tous les 40 m² ou tous les 8 mètres linéaires.

You can find the detailed up-to-date installation guide by visiting our website www.anticcolonial.com

Puedes revisar estas instrucciones de instalación actualizadas y con mas detalle visitando nuestra pagina web www.anticcolonial.com

Les dernières mises à jour sur les conseils d'installation et des informations complémentaires sont disponibles sur notre site web www.anticcolonial.com

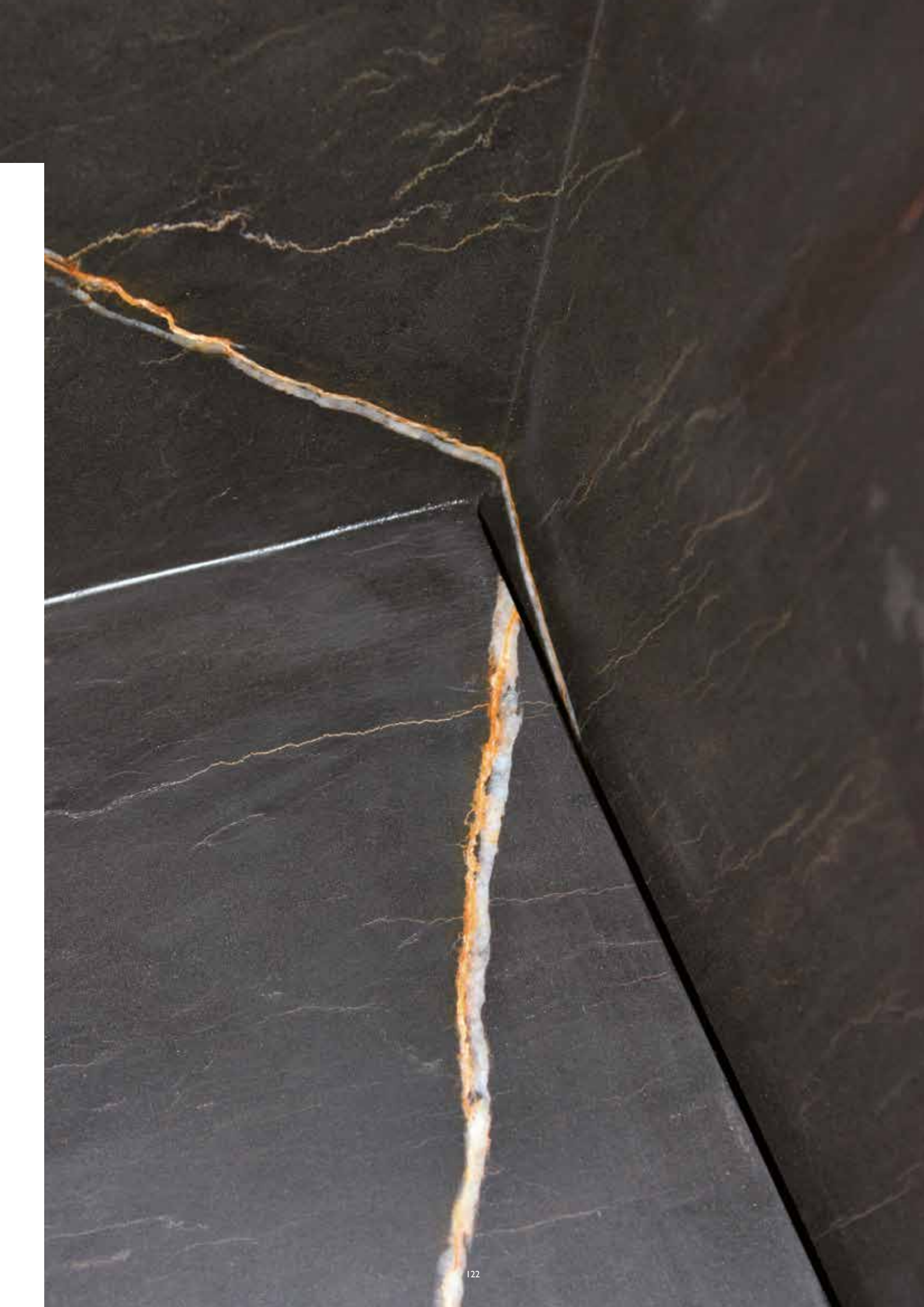

BATHROOMS

All L'Antic Colonial accessories are produced from natural products which may be subject to shade variations. The colour of the material supplied may differ slightly from that shown. Our website (<http://anticcolonial.com/banos/en/bathrooms/>) contains further information in respect of our designs, such as fitting instructions, technical specifications and drawings, details on textures or maintenance recommendations.

Todos los complementos de L'Antic Colonial están realizados con productos naturales que pueden sufrir variaciones de tono. El color del material servido puede no ser exactamente igual al de la muestra. En nuestra página web (<http://anticcolonial.com/banos/>) encontrará información adicional de nuestros diseños como instrucciones de colocación, fichas técnicas, dibujos técnicos y texturas o recomendaciones de mantenimiento.

Tous les compléments de L'Antic Colonial sont fabriqués avec des produits naturels qui peuvent subir des variations de tonalité. La couleur du matériau fourni peut être légèrement différente de celle de l'échantillon. Sur notre site Internet (<http://anticcolonial.com/fr/salles-de-bain/>), vous trouverez des informations supplémentaires sur nos créations : instructions de pose, fiches techniques, dessins techniques, textures ou recommandations pour l'entretien.

MADE-TO-MEASURE COMPLEMENTARY ITEMS / COMPLEMENTOS A MEDIDA / COMPLEMENTS SUR MESURE

L'Antic Colonial has a technical team that is specialized in making made-to-measure complementary items to meet specific project requirements.

L'Antic Colonial dispone de un equipo técnico especializado en la realización de complementos especiales a medida para adaptarse a las necesidades específicas de cada proyecto.

L'Antic Colonial dispose d'une équipe technique spécialisée dans la conception de compléments spéciaux sur mesure capables de s'adapter aux besoins spécifiques de chaque projet.



Download form
Descargar ficha
Télécharger la che

PORCELANOSA

L'ANTIC COLONIAL
Inspiring spaces. Inspired by nature

15122016

Ctra. Nacional 340, Km. 54. 12540 Vila-real
tel: (+34) 964 534 545
fax: (+34) 964 534 258
www.anticcolonial.com
anticcolonial@anticcolonial.com

Plano | Plan | Plan | Pianta | Plano | Plan | **Плана**

Fecha | Date | Date | Data | Data | Datum | **Дата**

Delegacion-Distribuidor | Branch-Distributor | Délégation-Distributeur | Filiale-Distributore | Delegação-Distribuidor | Niederlassung-Vertriebshändler

- Encimera | Vanity top | Tablette | Top | Bancada | Abdeckplatte | **Столешница**
- Lavabo | Washbasin | Lavabo | Lavabo | Lavatório | Waschtisch | **Умывальная раковина**
- Plato de Ducha | Shower tray | Receveur de douche | Piatto doccia | Prato de Duche | Duschbecken | **Поддон для душа**
- Peldaño | Step | Marche | Gradino | Degrau | Stufe | **Ступенька**
- Otros | Others | Autres | Altri | Outros | Andere | **Прочее**

Material | Material | Matériau | Materiale | Material | Material | **Материал**

Acabado | Finish | Finition | Finitura | Acabamento | Ausführung | **Отделка**

- Pulido | Polished | Polie | Lucidato | Polido | Poliert | **Полировка**
- Aromazado | Honed | Poncée | Impomciato | Alisado | Feingeschliffen | **Пемзование**
- Cepillado | Brushed | Brossée | Spazzolato | Escovado | Gebürstet | **Обработка щетки**
- Natural | Natural | Naturelle | Naturale | Natural | Natur | **Натуральная**
- Otros | Others | Autres | Altri | Outros | Andere | **Прочее**

Tipo de canto | Edge type | Type de bord | Tipo di spigolo | Art der Kanten | **Тип края**

- Recto Visto | Rectified | Direto visto | Diritto vista | Droit adouci | **прямой угол**
- Redondeado | Rounded | Arrondi | Arrotondato | Arredondado | Abgerundet | **Закругленный**
- 1/2 Redondeado | 1/2 Rounded | 1/2 Arrondi | 1/2 Arrotondato | 1/2 Arredondado | 1/2 abgerundet | 1/2 **Закругленный**

Lavabo | Washbasin | Lavabo | Lavabo | Lavatório | Waschtisch | **Умывальная раковина**

Modelo, Disposición y Fabricante | Model, layout and manufacturer | Modèle, disposition et fabricant | Modello, disposizione e produttore |
Modelo, Disposição e Fabricante | Modell, Anbringung und Hersteller | **Модель, Расположение и Изготовитель**

Plano | Plan | Plan | Pianta | Plano | Plan | **Плана**



Firma | Signature | Signature | Firma | Notas | Unterschrift | **Подпись**

*Special countertops do not include brackets / Las encimeras especiales no incluyen soportes / Les tablettes spéciales sont fournies sans supports

DESCRIPTION OF ICONS / DESCRIPCIÓN DE ICONOS / DESCRIPTION DES ICONES

Special sizes can be made to meet specific customer requirements.

Se pueden elaborar formatos especiales adaptados a las necesidades de cada cliente.

Possibilité de fabriquer des formats spéciaux adaptés aux besoins de chaque client.

L'Antic Colonial recommends the use of taps with an aerator in all its washbasins to reduce splashing.

L'Antic Colonial recomienda el uso de grifos con aireador en todos sus lavabos para reducir las salpicaduras de agua.

De manière à réduire les éclaboussures d'eau, L'Antic Colonial recommande l'installation de robinets équipés d'un aérateur sur tous ses lavabos.



BIOPROT

Protection that reduces drastically the emergence of most common household bacteria.

BIOPROT

Protección que reduce radicalmente la aparición de las bacterias domesticas mas comunes.

BIOPROT

Protection qui réduit de façon radicale l'apparition des bactéries domestiques les plus communes.



WASHBASIN ON SUPPORT

Washbasin installed on a countertop or cabinet.

LAVABO DE APOYO

Lavabo colocado sobre una encimera o mueble.

VASQUE À POSER

Lavabo placé sur un plan de toilette ou un meuble.



WALL-MOUNTED WASHBASIN

Washbasin that is affixed to the wall.

LAVABO SUSPENDIDO

Lavabo anclado a la pared.

LAVABO SUSPENDU

Lavabo fixé au mur.



FREE-STANDING WASHBASIN

Washbasin with a base that reaches the floor of the room.

LAVABO DE PIE

Lavabo con base que llega hasta el pavimento de la estancia.

LAVABO SUR PIED

Lavabo dont la base arrive jusqu'au sol de la pièce.



SEMI-RECESSED WASHBASIN

Embedded washbasin that cuts through the countertop partially.

LAVABO DE SEMI-ENCASTRE

Lavabo encajado que atraviesa la encimera parcialmente.

LAVABO SEMI-ENCASTRÉ

Lavabo encastré qui traverse partiellement le plan de toilette.



RECESSED WASHBASIN

Washbasin installed under the countertop.

LAVABO DE ENCASTRE

Lavabo colocado por la parte inferior de una encimera.

LAVABO ENCASTRÉ

Lavabo encastré par la partie inférieure du plan de toilette.



IRREGULAR TEXTURE

Material that stands out for having an asymmetrical surface.

TEXTURA IRREGULAR

Material que destaca por tener una superficie asimétrica.

TEXTURE IRRÉGULIÈRE

Matériau qui se distingue par sa surface asymétrique.



GLOSS

Material with surface with the ability to produce reflections.

BRILLO

Material cuya superficie tiene la capacidad de producir reflejos.

ÉCLAT

Matériau dont la surface est en mesure de produire des reflets.



MATT

Material with a gloss-free surface.

MATE

Material cuya superficie carece de brillo.

MAT

Matériau dont la surface n'est pas brillante.



Complementary products Lavabo Faces Mural Grey Stone



Floor Coverings Kayak Beige Pulido / Wall Coverings Habana Brown Pulido / Complementary products Krabi Persian White, W-Tower Roble Clody



WASHBASIN LAVABOS LAVABOS

.....

Krabi
Phuket
Buddha
Basic Stand
Duomo Plus
Soul Hollow
Shima
Geisha
Conjunto Zen
Zeno
Trend
Core
Navona
Shape
Basic
Maya
Round
Basic

WASHBASIN / LAVABOS / LAVABOS

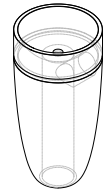
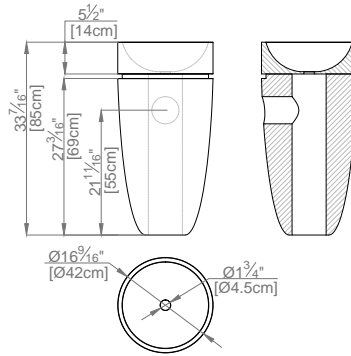

The set includes / El conjunto incluye / L'ensemble comprend les éléments suivants:
 -Wash basin / Lavabo / Lavabo.
 -Maintenance kit / Kit de mantenimiento / Kit d'entretien.

Krabi



Description	Format	Codes	Group	Pcs	m2	Kg
Beige Classico	42x85 cm 16 9/16" x 33 7/16"	100032019 L170801072	G-188	1 x Cj 1 x Pal	-	269 x Cj 206 Neto
Blanco Almeria Classico	42x85 cm 16 9/16" x 33 7/16"	100032015 L170801063	G-188	1 x Cj 1 x Pal	-	269 x Cj 206 Neto
Persian White Classico	42x85 cm 16 9/16" x 33 7/16"	100177083 L179702885	G-188	1 x Cj 1 x Pal	-	269 x Cj 206 Neto
Habana Dark Classico	42x85 cm 16 9/16" x 33 7/16"	100045561 L170801102	G-188	1 x Cj 1 x Pal	-	269 x Cj 206 Neto
Crema Italia Classico	42x85 cm 16 9/16" x 33 7/16"	100032018 L170801064	G-188	1 x Cj 1 x Pal	-	269 x Cj 206 Neto
Grey Stone Classico	42x85 cm 16 9/16" x 33 7/16"	100045562 L170801099	G-188	1 x Cj 1 x Pal	-	269 x Cj 206 Neto

Qmax L/min= 12 l/min (Pressure/Presión/Pression= 3 bar).



Casquillo Desagüe 2Cm Cromo
100043169 - N899393001
NOKEN



Vaciador Fijo Sin Rebosadero Cromo
100040383 - N299606001
NOKEN



Stone waste cover / Embellecedor Piedra / Élément Décoratif Pierre
 Hidden-drain pedestals are available on order in the same material and with the same finish as that used for the wash basin. / Los embellecedores del desagüe pueden realizarse bajo pedido con el mismo material y acabado que el lavabo. / Sur demande, les éléments décoratifs du drain peuvent être fabriqués dans le même matériel et avec les mêmes finitions que le lavabo.
 (See page / Ver página / Voir page 139).

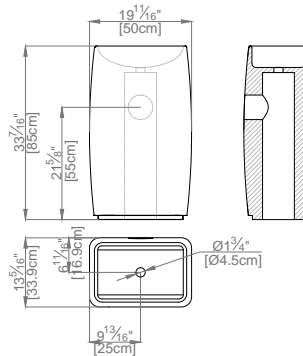

The set includes / El conjunto incluye / L'ensemble comprend les éléments suivants:
 -Wash basin / Lavabo / Lavabo.
 -Maintenance kit / Kit de mantenimiento / Kit d'entretien.

Phuket



Description	Format	Codes	Group	Pcs	m2	Kg
Beige Classico	50x33.9x85 cm 19 11/16" x 13 5/16" x 33 7/16"	100068752 L170302276	G-190	1 x Cj 1 x Pal	-	300 x Cj 237 Neto
Blanco Almeria Classico	50x33.9x85 cm 19 11/16" x 13 5/16" x 33 7/16"	100068747 L170302275	G-190	1 x Cj 1 x Pal	-	300 x Cj 237 Neto
Persian White Classico	50x33.9x85 cm 19 11/16" x 13 5/16" x 33 7/16"	100177066 L179702887	G-190	1 x Cj 1 x Pal	-	300 x Cj 237 Neto
Habana Dark Classico	50x33.9x85 cm 19 11/16" x 13 5/16" x 33 7/16"	100057408 L171301061	G-190	1 x Cj 1 x Pal	-	300 x Cj 237 Neto
Crema Italia Classico	50x33.9x85 cm 19 11/16" x 13 5/16" x 33 7/16"	100068748 L170302277	G-190	1 x Cj 1 x Pal	-	300 x Cj 237 Neto
Grey Stone Classico	50x33.9x85 cm 19 11/16" x 13 5/16" x 33 7/16"	100068749 L170302272	G-190	1 x Cj 1 x Pal	-	300 x Cj 237 Neto

Qmax L/min= 12 l/min (Pressure/Presión/Pression= 3 bar).



Casquillo Desagüe 2Cm Cromo
100043169 - N899393001
NOKEN



Vaciador Fijo Sin Rebosadero Cromo
100040383 - N299606001
NOKEN



Stone waste cover / Embellecedor Piedra / Élément Décoratif Pierre
 Hidden-drain pedestals are available on order in the same material and with the same finish as that used for the wash basin. / Los embellecedores del desagüe pueden realizarse bajo pedido con el mismo material y acabado que el lavabo. / Sur demande, les éléments décoratifs du drain peuvent être fabriqués dans le même matériel et avec les mêmes finitions que le lavabo.
 (See page / Ver página / Voir page 139).

WASHBASIN / LAVABOS / LAVABOS

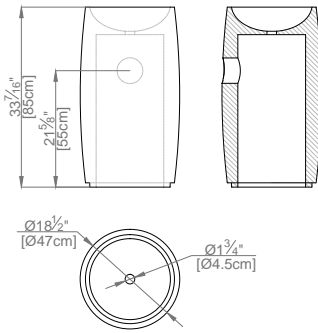

The set includes / El conjunto incluye / L'ensemble comprend les éléments suivants:
 -Wash basin / Lavabo / Lavabo.
 -Maintenance kit / Kit de mantenimiento / Kit d'entretien.



Casquillo Desagüe 2Cm Cromo
 100043169 - N899393001
 NOKEN



Vaciador Fijo Sin Rebosadero Cromo
 100040383 - N299606001
 NOKEN



Stone waste cover / Embellecedor Piedra / Élément Décoratif Pierre
 Hidden-drain pedestals are available on order in the same material and with the same finish as that used for the wash basin. / Los embellecedores del desagüe pueden realizarse bajo pedido con el mismo material y acabado que el lavabo. / Sur demande, les éléments décoratifs du drain peuvent être fabriqués dans le même matériel et avec les mêmes finitions que le lavabo.
 (See page / Ver página / Voir page 139).

Buddha



MATT



FREE-STANDING WASHBASIN



BIOPROT

Description	Format	Codes	Group	Pcs	m2	Kg
Beige Classico	47x85 cm 18 1/2" x 33 7/16"	100068770 L170302393	G-192	1 x Cj 1 x Pal	-	297 x Cj 234 Neto
Blanco Almeria Classico	47x85 cm 18 1/2" x 33 7/16"	100062164 L171301072	G-192	1 x Cj 1 x Pal	-	297 x Cj 234 Neto
Persian White Classico	47x85 cm 18 1/2" x 33 7/16"	100177065 L179702880	G-192	1 x Cj 1 x Pal	-	297 x Cj 234 Neto
Habana Dark Classico	47x85 cm 18 1/2" x 33 7/16"	100057405 L171301060	G-192	1 x Cj 1 x Pal	-	297 x Cj 234 Neto
Crema Italia Classico	47x85 cm 18 1/2" x 33 7/16"	100068767 L170302400	G-192	1 x Cj 1 x Pal	-	297 x Cj 234 Neto
Grey Stone Classico	47x85 cm 18 1/2" x 33 7/16"	100068745 L170302388	G-192	1 x Cj 1 x Pal	-	297 x Cj 234 Neto

Qmax L/min=12 l/min (Pressure/Presión/Pression= 3 bar).

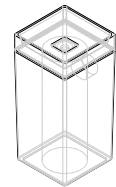
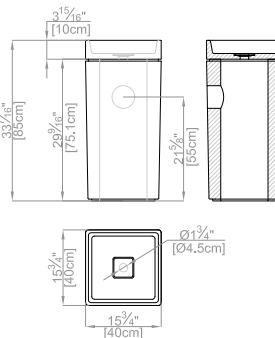

The set includes / El conjunto incluye / L'ensemble comprend les éléments suivants:
 -Wash basin / Lavabo / Lavabo.
 -Maintenance kit / Kit de mantenimiento / Kit d'entretien.



Casquillo Desagüe 2Cm Cromo
 100043169 - N899393001
 NOKEN



Vaciador Fijo Sin Rebosadero Cromo
 100040383 - N299606001
 NOKEN

Basic Stand



MATT



FREE-STANDING WASHBASIN



BIOPROT

Description	Format	Codes	Group	Pcs	m2	Kg
Beige Classico	40x40x85 cm 15 3/4" x 15 3/4" x 33 7/16"	100146426 L179702409	G-193	1 x Cj 1 x Pal	-	294 x Cj 234 Neto
Blanco Almeria Classico	40x40x85 cm 15 3/4" x 15 3/4" x 33 7/16"	100146424 L179702438	G-193	1 x Cj 1 x Pal	-	294 x Cj 234 Neto
Persian White Classico	40x40x85 cm 15 3/4" x 15 3/4" x 33 7/16"	100177081 L179702881	G-193	1 x Cj 1 x Pal	-	294 x Cj 234 Neto
Habana Dark Classico	40x40x85 cm 15 3/4" x 15 3/4" x 33 7/16"	100146488 L179702421	G-193	1 x Cj 1 x Pal	-	294 x Cj 234 Neto
Crema Italia Classico	40x40x85 cm 15 3/4" x 15 3/4" x 33 7/16"	100146427 L179702431	G-193	1 x Cj 1 x Pal	-	294 x Cj 234 Neto
Grey Stone Classico	40x40x85 cm 15 3/4" x 15 3/4" x 33 7/16"	100146489 L179702441	G-193	1 x Cj 1 x Pal	-	294 x Cj 234 Neto

Qmax L/min=12 l/min (Pressure/Presión/Pression= 3 bar).

WASHBASIN / LAVABOS / LAVABOS

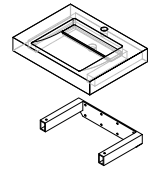
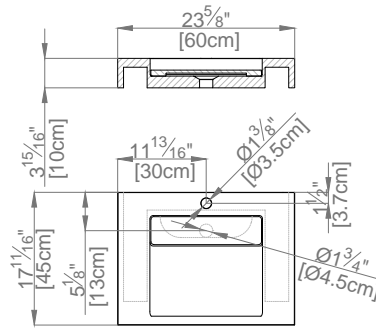

The set includes / El conjunto incluye / L'ensemble comprend les éléments suivants:
 -Wash basin / Lavabo / Lavabo.
 -Stone waste cover / Embellecedor piedra / Élément décoratif Pierre.
 -Bracket / Escuadra de sujeción / Équerre de fixation.
 -Screws / Tornillería / Visserie.

Duomo Plus



Description	Format	Codes	Group	Pcs	m2	Kg
Beige Classico	60x45x10 cm 23 5/8"x17 11/16"x3 7/8"	100113896 L170302707	G-182	1 x Cj 1 x Pal	-	71 x Cj 50 Neto
Blanco Almeria Classico	60x45x10 cm 23 5/8"x17 11/16"x3 7/8"	100113893 L170302709	G-182	1 x Cj 1 x Pal	-	71 x Cj 50 Neto
Persian White Classico	60x45x10 cm 23 5/8"x17 11/16"x3 7/8"	100177091 L179702879	G-182	1 x Cj 1 x Pal	-	71 x Cj 50 Neto
Habana Dark Classico	60x45x10 cm 23 5/8"x17 11/16"x3 7/8"	100113895 L170302703	G-182	1 x Cj 1 x Pal	-	71 x Cj 50 Neto
Crema Italia Classico	60x45x10 cm 23 5/8"x17 11/16"x3 7/8"	100113897 L170302700	G-182	1 x Cj 1 x Pal	-	71 x Cj 50 Neto
Grey Stone Classico	60x45x10 cm 23 5/8"x17 11/16"x3 7/8"	100113899 L170302708	G-182	1 x Cj 1 x Pal	-	71 x Cj 50 Neto

Qmax L/min=12 l/min (Pressure/Presión/Pression= 3 bar).



Casquillo Desagüe 2Cm Cromo
100043169 - N899393001
NOKEN



Vaciador Fijo Sin Rebosadero Cromo
100040383 - N299606001
NOKEN

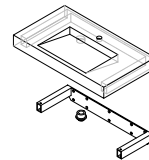
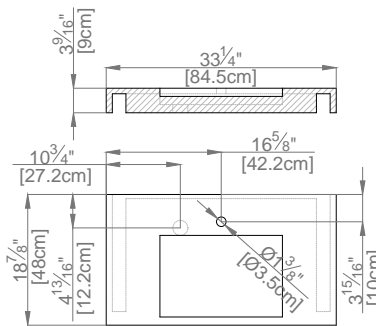

The set includes / El conjunto incluye / L'ensemble comprend les éléments suivants:
 -Wash basin / Lavabo / Lavabo.
 -Coupling / Junta de conexión / Joint de raccordement.
 -Bracket / Escuadra de sujeción / Équerre de fixation.
 -Screws / Tornillería / Visserie.

Soul Hollow



Description	Format	Codes	Group	Pcs	m2	Kg
Beige Classico	48x84,5x9 cm 18 7/8"x33 1/4"x3 9/16"	100113902 L170302701	G-183	1 x Cj 1 x Pal	-	120 x Cj 74 Neto
Blanco Almeria Classico	48x84,5x9 cm 18 7/8"x33 1/4"x3 9/16"	100113823 L170302689	G-183	1 x Cj 1 x Pal	-	120 x Cj 74 Neto
Persian White Classico	48x84,5x9 cm 18 7/8"x33 1/4"x3 9/16"	100177094 L179702889	G-183	1 x Cj 1 x Pal	-	120 x Cj 74 Neto
Habana Dark Classico	48x84,5x9 cm 18 7/8"x33 1/4"x3 9/16"	100113849 L170302695	G-183	1 x Cj 1 x Pal	-	120 x Cj 74 Neto
Crema Italia Classico	48x84,5x9 cm 18 7/8"x33 1/4"x3 9/16"	100113850 L170302698	G-183	1 x Cj 1 x Pal	-	120 x Cj 74 Neto
Grey Stone Classico	48x84,5x9 cm 18 7/8"x33 1/4"x3 9/16"	100113903 L170302710	G-183	1 x Cj 1 x Pal	-	120 x Cj 74 Neto

Qmax L/min=10 l/min (Pressure/Presión/Pression= 3 bar).

WASHBASIN / LAVABOS / LAVABOS

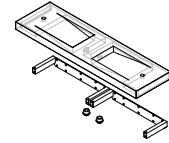
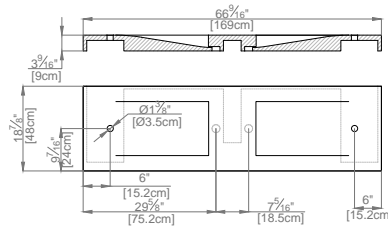

The set includes / El conjunto incluye / L'ensemble comprend les éléments suivants:
 -Wash basin / Lavabo / Lavabo.
 -Coupling / Junta de conexión / Joint de raccordement.
 -Bracket / Escuadra de sujeción / Équerre de fixation.
 -Screws / Tornillería / Visserie.

Shima



Description	Format	Codes	Group	Pcs	m2	Kg
Beige Classico	169x48x9 cm 66 9/16"x18 7/8"x3 9/16"	100068093 L171301102	G-192	1 x Cj 1 x Pal	- -	260 x Cj 206 Neto
Blanco Almeria Classico	169x48x9 cm 66 9/16"x18 7/8"x3 9/16"	100068088 L171301106	G-192	1 x Cj 1 x Pal	- -	260 x Cj 206 Neto
Persian White Classico	169x48x9 cm 66 9/16"x18 7/8"x3 9/16"	100177067 L179702888	G-192	1 x Cj 1 x Pal	- -	260 x Cj 206 Neto
Habana Dark Classico	169x48x9 cm 66 9/16"x18 7/8"x3 9/16"	100068092 L171301101	G-192	1 x Cj 1 x Pal	- -	260 x Cj 206 Neto
Crema Italia Classico	169x48x9 cm 66 9/16"x18 7/8"x3 9/16"	100068089 L171301105	G-192	1 x Cj 1 x Pal	- -	260 x Cj 206 Neto
Grey Stone Classico	169x48x9 cm 66 9/16"x18 7/8"x3 9/16"	100068102 L171301108	G-192	1 x Cj 1 x Pal	- -	260 x Cj 206 Neto

Qmax L/min=7 l/min (Pressure/Presión/Pression= 3 bar).

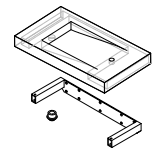
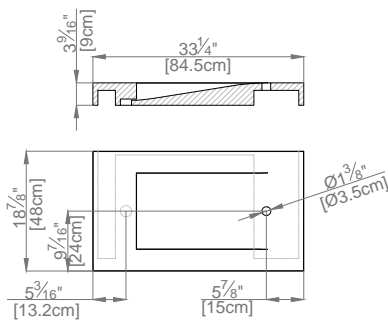

The set includes / El conjunto incluye / L'ensemble comprend les éléments suivants:
 -Wash basin / Lavabo / Lavabo.
 -Coupling / Junta de conexión / Joint de raccordement.
 -Bracket / Escuadra de sujeción / Équerre de fixation.
 -Screws / Tornillería / Visserie.

Geisha



Description	Format	Codes	Group	Pcs	m2	Kg
Beige Classico	84.5x48x9 cm 33 1/4"x18 7/8"x3 9/16"	100068100 L170302231	G-182	1 x Cj 1 x Pal	- -	110 x Cj 84 Neto
Blanco Almeria Classico	84.5x48x9 cm 33 1/4"x18 7/8"x3 9/16"	100068095 L170302191	G-182	1 x Cj 1 x Pal	- -	110 x Cj 84 Neto
Persian White Classico	84.5x48x9 cm 33 1/4"x18 7/8"x3 9/16"	100177074 L179702884	G-182	1 x Cj 1 x Pal	- -	110 x Cj 84 Neto
Habana Dark Classico	84.5x48x9 cm 33 1/4"x18 7/8"x3 9/16"	100068098 L170302201	G-182	1 x Cj 1 x Pal	- -	110 x Cj 84 Neto
Crema Italia Classico	84.5x48x9 cm 33 1/4"x18 7/8"x3 9/16"	100068096 L170302211	G-182	1 x Cj 1 x Pal	- -	110 x Cj 84 Neto
Grey Stone Classico	84.5x48x9 cm 33 1/4"x18 7/8"x3 9/16"	100068104 L170302251	G-182	1 x Cj 1 x Pal	- -	110 x Cj 84 Neto

Qmax L/min=7.5 l/min (Pressure/Presión/Pression= 3 bar).

WASHBASIN / LAVABOS / LAVABOS

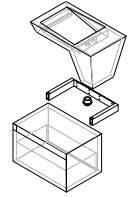
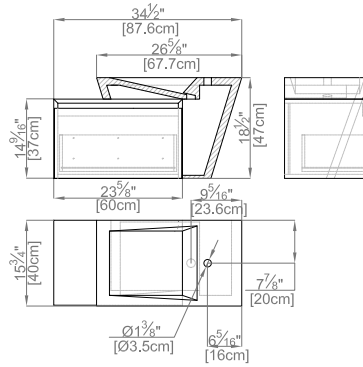

The set includes / El conjunto incluye / L'ensemble comprend les éléments suivants:

- Wash basin / Lavabo / Lavabo.
- Coupling / Junta de conexión / Joint de raccordement.
- Bracket / Escuadra de sujeción / Équerre de fixation.
- Screws / Tornillería / Visserie.
- Furniture / Mueble / Meuble.

Zen Wood



MATT

WALL-MOUNTED
WASHBASIN

BIOPROT

Description	Format	Codes	Group	Pcs	m2	Kg
Persian White / Roble Cloudy	87,5x40x47 cm 33 1/4"x18 7/8"x3 9/16"	100177277 L179702903	G-190	1 x Cj 1 x Pal	-	110 x Cj 90 Neto
Persian White / Nogal Intense	87,5x40x47 cm 33 1/4"x18 7/8"x3 9/16"	100177295 L179702907	G-190	1 x Cj 1 x Pal	-	110 x Cj 90 Neto
Persian White / Roble Sunset	87,5x40x47 cm 33 1/4"x18 7/8"x3 9/16"	100177303 L179702906	G-190	1 x Cj 1 x Pal	-	110 x Cj 90 Neto
Persian White / Nogal Warm	87,5x40x47 cm 33 1/4"x18 7/8"x3 9/16"	100177286 L179702905	G-190	1 x Cj 1 x Pal	-	110 x Cj 90 Neto
Habana Dark / Roble Cloudy	87,5x40x47 cm 33 1/4"x18 7/8"x3 9/16"	100155880 L179702549	G-190	1 x Cj 1 x Pal	-	110 x Cj 90 Neto
Habana Dark / Nogal Intense	87,5x40x47 cm 33 1/4"x18 7/8"x3 9/16"	100110776 L170302645	G-190	1 x Cj 1 x Pal	-	110 x Cj 90 Neto
Habana Dark / Roble Sunset	87,5x40x47 cm 33 1/4"x18 7/8"x3 9/16"	100155883 L179702555	G-190	1 x Cj 1 x Pal	-	110 x Cj 90 Neto
Habana Dark / Nogal Warm	87,5x40x47 cm 33 1/4"x18 7/8"x3 9/16"	100110777 L170302649	G-190	1 x Cj 1 x Pal	-	110 x Cj 90 Neto
Beige / Roble Cloudy	87,5x40x47 cm 33 1/4"x18 7/8"x3 9/16"	100155886 L179702556	G-190	1 x Cj 1 x Pal	-	110 x Cj 90 Neto
Beige / Nogal Intense	87,5x40x47 cm 33 1/4"x18 7/8"x3 9/16"	100110778 L170302647	G-190	1 x Cj 1 x Pal	-	110 x Cj 90 Neto
Beige / Roble Sunset	87,5x40x47 cm 33 1/4"x18 7/8"x3 9/16"	100155889 L179702559	G-190	1 x Cj 1 x Pal	-	110 x Cj 90 Neto
Beige / Nogal Warm	87,5x40x47 cm 33 1/4"x18 7/8"x3 9/16"	100110779 L170302646	G-190	1 x Cj 1 x Pal	-	110 x Cj 90 Neto
Crema Italia / Roble Cloudy	87,5x40x47 cm 33 1/4"x18 7/8"x3 9/16"	100155891 L179702562	G-190	1 x Cj 1 x Pal	-	110 x Cj 90 Neto
Crema Italia / Nogal Intense	87,5x40x47 cm 33 1/4"x18 7/8"x3 9/16"	100110766 L170302650	G-190	1 x Cj 1 x Pal	-	110 x Cj 90 Neto
Crema Italia / Roble Sunset	87,5x40x47 cm 33 1/4"x18 7/8"x3 9/16"	100155894 L179702568	G-190	1 x Cj 1 x Pal	-	110 x Cj 90 Neto
Crema Italia / Nogal Warm	87,5x40x47 cm 33 1/4"x18 7/8"x3 9/16"	100110767 L170302651	G-190	1 x Cj 1 x Pal	-	110 x Cj 90 Neto

Qmax L/min=6 l/min (Pressure/Presión/Pression= 3 bar).

SPECIFICATIONS FOR TAPS
ESPECIFICACIONES PARA LA GRIFERIA
SPECIFICATIONS POUR LA
ROBINETTERIE

Higher flows could lead to the overflow of the basin. We recommend using aerator 100072948 - N299999734 STANDARD AERATOR, which reduces flow to 3.5 liters/min and consequently water use. For basins with a hidden waste we recommend that the water from the tap falls between 6 and 12cm from the waste to help the water to drain correctly and avoid the basin from filling up with water.

Se recomienda el uso del aireador 100072948 - N299999734 AIREADOR ESTANDAR que reduce el caudal a 3.5 litros/min y consecuentemente el consumo de agua. En los lavabos con desagüe oculto se recomienda que la caída del agua del grifo esté entre 6 y 12 centímetros del desagüe para evitar que el agua se estanque y pueda evacuar correctamente.

Il est recommandé d'utiliser l'aérateur 100072948 - N299999734 AIREADOR ESTANDAR qui réduit le débit à 3,5 litres/min et, par conséquent, la consommation d'eau. Sur les lavabos dont la bonde est invisible, il est recommandé que la chute d'eau depuis le robinet tombe entre 6 et 12 cm du percement d'évacuation afin que l'eau puisse s'évacuer correctement.

WASHBASIN / LAVABOS / LAVABOS

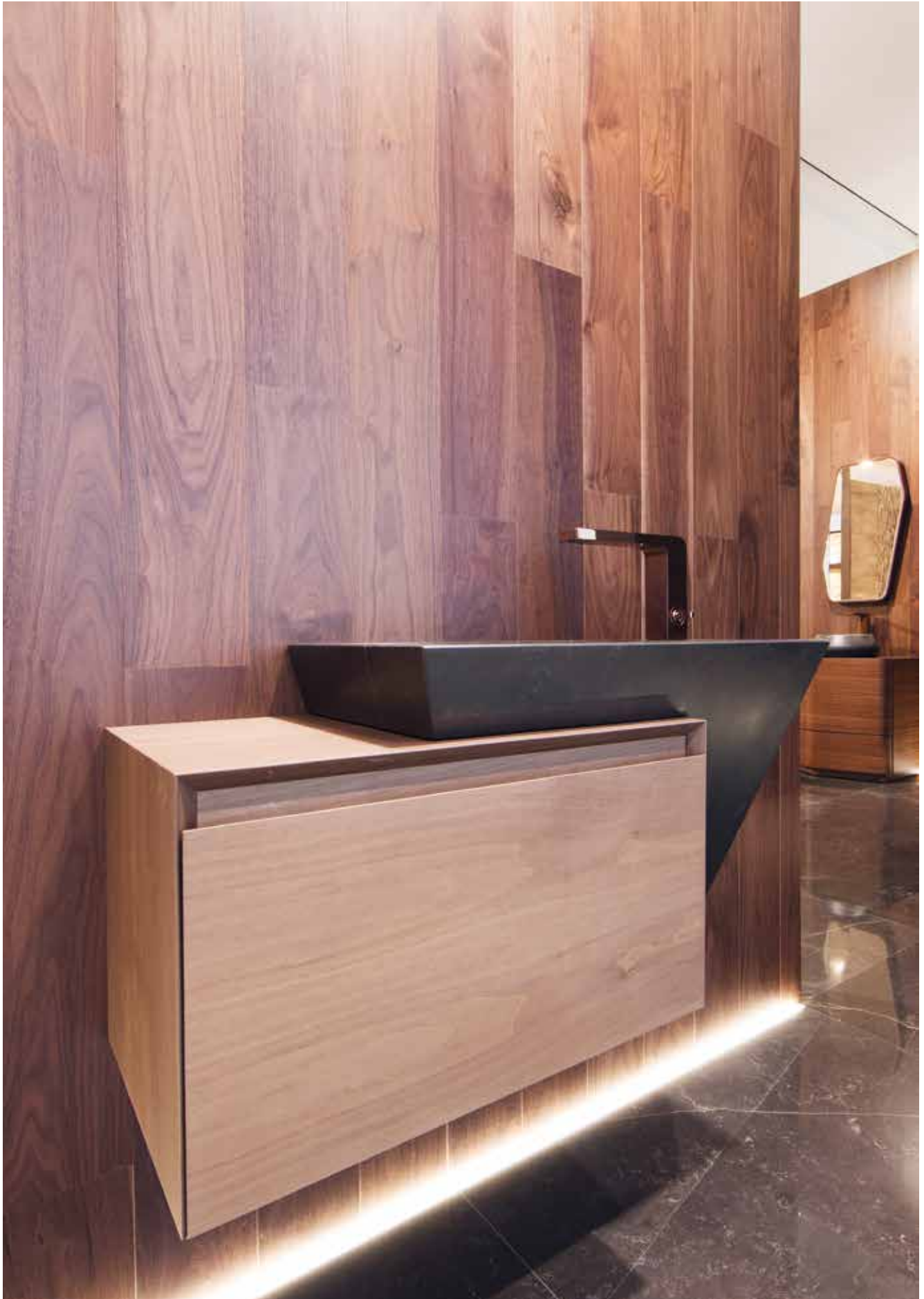

Complementary products Conjunto Zen Wood Habana Dark / Nogal Warm

WASHBASIN / LAVABOS / LAVABOS

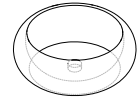
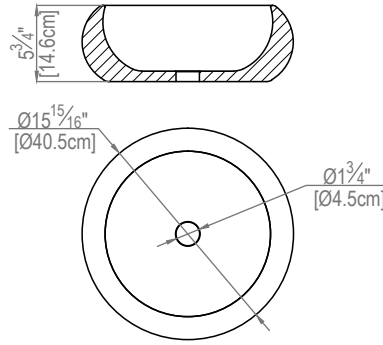

The set includes / El conjunto incluye / L'ensemble comprend les éléments suivants:
-Wash basin / Lavabo / Lavabo.



Casquillo Desagüe 2Cm Cromo
100043169 - N899393001
NOKEN



Vaciador Fijo Sin Rebosadero Cromo
100040383 - N299606001
NOKEN



Stone waste cover / Embellecedor Piedra / Élément Décoratif Pierre
Hidden-drain pedestals are available on order in the same material and with the same finish as that used for the wash basin. / Los embellecedores del desagüe pueden realizarse bajo pedido con el mismo material y acabado que el lavabo. / Sur demande, les éléments décoratifs du drain peuvent être fabriqués dans le même matériel et avec les mêmes finitions que le lavabo.
(See page / Ver página / Voir page 139).

Zeno



GLOSS



WASHBASIN ON SUPPORT



BIOPROT

Description	Format	Codes	Group	Pcs	m2	Kg
Beige Pulido	40,5x14,6 cm 15 15/16"x5 3/4"	100002226 L171301031	G-179	1 x Cj 6 x Pal	-	23 x Cj 18,70 Neto
Blanco Almeria Pulido	40,5x14,6 cm 15 15/16"x5 3/4"	100002227 L171301041	G-179	1 x Cj 6 x Pal	-	23 x Cj 18,70 Neto
Persian White Pulido	40,5x14,6 cm 15 15/16"x5 3/4"	100177077 L170302908	G-179	1 x Cj 6 x Pal	-	23 x Cj 18,70 Neto
Habana Dark Pulido	40,5x14,6 cm 15 15/16"x5 3/4"	100068842 L170302383	G-179	1 x Cj 6 x Pal	-	23 x Cj 18,70 Neto
Crema Italia Pulido	40,5x14,6 cm 15 15/16"x5 3/4"	100002223 L171301001	G-179	1 x Cj 6 x Pal	-	23 x Cj 18,70 Neto
Grey Stone Pulido	40,5x14,6 cm 15 15/16"x5 3/4"	100068843 L170302366	G-179	1 x Cj 6 x Pal	-	23 x Cj 18,70 Neto

Qmax L/min=12 l/min (Pressure/Presión/Pression= 3 bar).

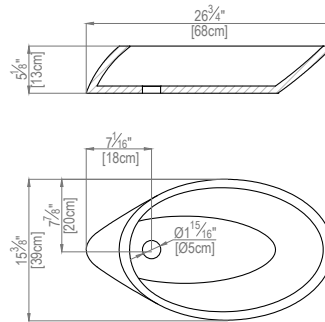

The set includes / El conjunto incluye / L'ensemble comprend les éléments suivants:
-Wash basin / Lavabo / Lavabo.



Casquillo Desagüe 2Cm Cromo
100043169 - N899393001
NOKEN



Vaciador Fijo Sin Rebosadero Cromo
100040383 - N299606001
NOKEN



Stone waste cover / Embellecedor Piedra / Élément Décoratif Pierre
Hidden-drain pedestals are available on order in the same material and with the same finish as that used for the wash basin. / Los embellecedores del desagüe pueden realizarse bajo pedido con el mismo material y acabado que el lavabo. / Sur demande, les éléments décoratifs du drain peuvent être fabriqués dans le même matériel et avec les mêmes finitions que le lavabo.
(See page / Ver página / Voir page 139).

Trend



MATT



WASHBASIN ON SUPPORT



BIOPROT

Description	Format	Codes	Group	Pcs	m2	Kg
Beige Classico	68x39x13 cm 26 3/4"x15 3/8"x5 1/8"	100093140 L171301205	G-182	1 x Cj 1 x Pal	-	72 x Cj 48 Neto
Blanco Almeria Classico	68x39x13 cm 26 3/4"x15 3/8"x5 1/8"	100093144 L171301206	G-182	1 x Cj 1 x Pal	-	72 x Cj 48 Neto
Persian White Classico	68x39x13 cm 26 3/4"x15 3/8"x5 1/8"	100177076 L179702916	G-182	1 x Cj 1 x Pal	-	72 x Cj 48 Neto
Habana Dark Classico	68x39x13 cm 26 3/4"x15 3/8"x5 1/8"	100093145 L171301211	G-182	1 x Cj 1 x Pal	-	72 x Cj 48 Neto
Crema Italia Classico	68x39x13 cm 26 3/4"x15 3/8"x5 1/8"	100093146 L171301211	G-182	1 x Cj 1 x Pal	-	72 x Cj 48 Neto
Grey Stone Classico	68x39x13 cm 26 3/4"x15 3/8"x5 1/8"	100093148 L171301210	G-182	1 x Cj 1 x Pal	-	72 x Cj 48 Neto

Qmax L/min=12 l/min (Pressure/Presión/Pression= 3 bar).

WASHBASIN / LAVABOS / LAVABOS

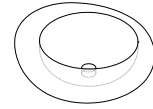
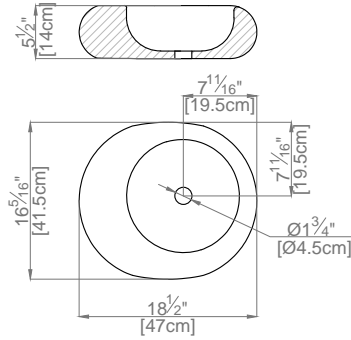

The set includes / El conjunto incluye / L'ensemble comprend les éléments suivants:
-Wash basin / Lavabo / Lavabo.

Core



Casquillo Desagüe 2Cm Cromo
100043169 - N899393001
NOKEN



Vaciador Fijo Sin Rebosadero Cromo
100040383 - N299606001
NOKEN



Stone waste cover / Embellecedor Piedra / Élément Décoratif Pierre
Hidden-drain pedestals are available on order in the same material and with the same finish as that used for the wash basin. / Los embellecedores del desagüe pueden realizarse bajo pedido con el mismo material y acabado que el lavabo. / Sur demande, les éléments décoratifs du drain peuvent être fabriqués dans le même matériel et avec les mêmes finitions que le lavabo.
(See page / Ver página / Voir page 139).

Description	Format	Codes	Group	Pcs	m2	Kg
Beige Classico	47x41.5x13.5 cm 18 1/2"x16 5/16"x5 5/16"	100032008 L170801112	G-179	1 x Cj 6 x Pal	- -	39 x Cj 35 Neto
Blanco Almeria Classico	47x41.5x13.5 cm 18 1/2"x16 5/16"x5 5/16"	100032004 L170801074	G-179	1 x Cj 6 x Pal	- -	39 x Cj 35 Neto
Persian White Classico	47x41.5x13.5 cm 18 1/2"x16 5/16"x5 5/16"	100177082 L179702922	G-179	1 x Cj 6 x Pal	- -	39 x Cj 35 Neto
Habana Dark Classico	47x41.5x13.5 cm 18 1/2"x16 5/16"x5 5/16"	100068891 L171301128	G-179	1 x Cj 6 x Pal	- -	39 x Cj 35 Neto
Crema Italia Classico	47x41.5x13.5 cm 18 1/2"x16 5/16"x5 5/16"	100032007 L170801110	G-179	1 x Cj 6 x Pal	- -	39 x Cj 35 Neto
Grey Stone Classico	47x41.5x13.5 cm 18 1/2"x16 5/16"x5 5/16"	100068892 L171301127	G-179	1 x Cj 6 x Pal	- -	39 x Cj 35 Neto

Qmax L/min=12 l/min (Pressure/Presión/Pression= 3 bar).

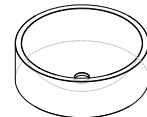
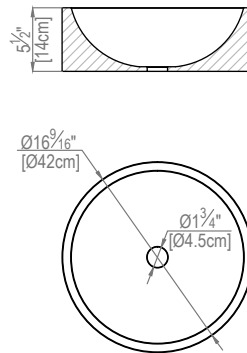

The set includes / El conjunto incluye / L'ensemble comprend les éléments suivants:
-Wash basin / Lavabo / Lavabo.



Casquillo Desagüe 2Cm Cromo
100043169 - N899393001
NOKEN



Vaciador Fijo Sin Rebosadero Cromo
100040383 - N299606001
NOKEN

Navona



Description	Format	Codes	Group	Pcs	m2	Kg
Beige Classico	42x14 cm 16 9/16" x 5 1/2"	100002187 L170501004	G-176	1 x Cj 6 x Pal	- -	37 x Cj 33 Neto
Blanco Almeria Classico	42x14 cm 16 9/16" x 5 1/2"	100002185 L170501001	G-176	1 x Cj 6 x Pal	- -	37 x Cj 33 Neto
Persian White Classico	42x14 cm 16 9/16" x 5 1/2"	100177092 L179702932	G-176	1 x Cj 6 x Pal	- -	37 x Cj 33 Neto
Habana Dark Classico	42x14 cm 16 9/16" x 5 1/2"	100068860 L170504008	G-176	1 x Cj 6 x Pal	- -	37 x Cj 33 Neto
Crema Italia Classico	42x14 cm 16 9/16" x 5 1/2"	100002186 L170501002	G-176	1 x Cj 6 x Pal	- -	37 x Cj 33 Neto
Grey Stone Classico	42x14 cm 16 9/16" x 5 1/2"	100068862 L170504012	G-176	1 x Cj 6 x Pal	- -	37 x Cj 33 Neto

Qmax L/min=12 l/min (Pressure/Presión/Pression= 3 bar).

WASHBASIN / LAVABOS / LAVABOS

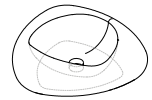
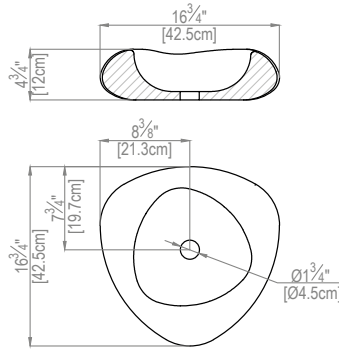

The set includes / El conjunto incluye / L'ensemble comprend les éléments suivants:
-Wash basin / Lavabo / Lavabo.



Casquillo Desagüe 2Cm Cromo
100043169 - N899393001
NOKEN



Vaciador Fijo Sin Rebosadero Cromo
100040383 - N299606001
NOKEN



Stone waste cover / Embellecedor Piedra / Élément Décoratif Pierre
Hidden-drain pedestals are available on order in the same material and with the same finish as that used for the wash basin. / Los embellecedores del desagüe pueden realizarse bajo pedido con el mismo material y acabado que el lavabo. / Sur demande, les éléments décoratifs du drain peuvent être fabriqués dans le même matériel et avec les mêmes finitions que le lavabo.
(See page / Ver página / Voir page 139).

Shape



MATT



WASHBASIN ON SUPPORT



BIOPROT

Description	Format	Codes	Group	Pcs	m2	Kg
Beige Classico	42,5x42,5x12 cm	100113817	G-182	1 x Cj	-	37 x Cj
	16 3/4"x16 3/4"x4 3/4"	L170302692		1 x Pal	-	33 Neto
Blanco Almeria Classico	42,5x42,5x12 cm	100113815	G-182	1 x Cj	-	37 x Cj
	16 3/4"x16 3/4"x4 3/4"	L170302684		1 x Pal	-	33 Neto
Persian White Classico	42,5x42,5x12 cm	100177093	G-182	1 x Cj	-	37 x Cj
	16 3/4"x16 3/4"x4 3/4"	L179702921		1 x Pal	-	33 Neto
Habana Dark Classico	42,5x42,5x12 cm	100113818	G-182	1 x Cj	-	37 x Cj
	16 3/4"x16 3/4"x4 3/4"	L170302691		1 x Pal	-	33 Neto
Crema Italia Classico	42,5x42,5x12 cm	100113819	G-182	1 x Cj	-	37 x Cj
	16 3/4"x16 3/4"x4 3/4"	L170302690		1 x Pal	-	33 Neto
Grey Stone Classico	42,5x42,5x12 cm	100113821	G-182	1 x Cj	-	37 x Cj
	16 3/4"x16 3/4"x4 3/4"	L170302694		1 x Pal	-	33 Neto

Qmax L/min=12 l/min (Pressure/Presión/Pression= 3 bar).

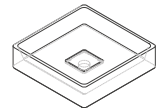
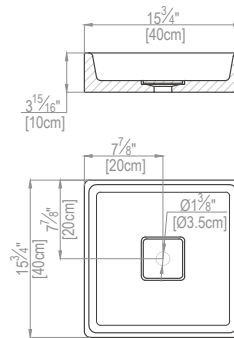

The set includes / El conjunto incluye / L'ensemble comprend les éléments suivants:
-Wash basin / Lavabo / Lavabo.
-Stone waste cover / Embellecedor piedra / Élément décoratif Pierre.



Casquillo Desagüe 2Cm Cromo
100043169 - N899393001
NOKEN



Vaciador Fijo Sin Rebosadero Cromo
100040383 - N299606001
NOKEN

Basic



MATT



WASHBASIN ON SUPPORT



BIOPROT

Description	Format	Codes	Group	Pcs	m2	Kg
Beige Classico	40x40x10 cm	100113807	G-179	1 x Cj	-	26 x Cj
	15 3/4"x15 3/4"x3 15/16"	L170302688		1 x Pal	-	22 Neto
Blanco Almeria Classico	40x40x10 cm	100113790	G-179	1 x Cj	-	26 x Cj
	15 3/4"x15 3/4"x3 15/16"	L170302681		1 x Pal	-	22 Neto
Persian White Classico	40x40x10 cm	100177073	G-179	1 x Cj	-	26 x Cj
	15 3/4"x15 3/4"x3 15/16"	L179702910		1 x Pal	-	22 Neto
Habana Dark Classico	40x40x10 cm	100113791	G-179	1 x Cj	-	26 x Cj
	15 3/4"x15 3/4"x3 15/16"	L170302676		1 x Pal	-	22 Neto
Crema Italia Classico	40x40x10 cm	100113792	G-179	1 x Cj	-	26 x Cj
	15 3/4"x15 3/4"x3 15/16"	L170302674		1 x Pal	-	22 Neto
Grey Stone Classico	40x40x10 cm	100113794	G-179	1 x Cj	-	26 x Cj
	15 3/4"x15 3/4"x3 15/16"	L170302679		1 x Pal	-	22 Neto

Qmax L/min=12 l/min (Pressure/Presión/Pression= 3 bar).

WASHBASIN / LAVABOS / LAVABOS

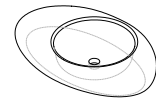
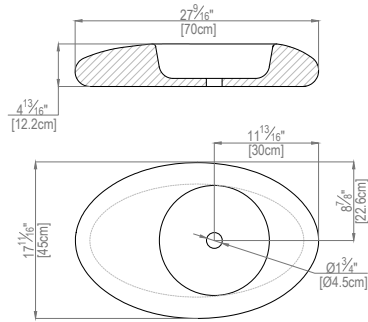

The set includes / El conjunto incluye / L'ensemble comprend les éléments suivants:
-Wash basin / Lavabo / Lavabo.



Casquillo Desagüe 2Cm Cromo
100043169 - N899393001
NOKEN



Vaciador Fijo Sin Rebosadero Cromo
100040383 - N299606001
NOKEN



Stone waste cover / Embellecedor Piedra / Élément Décoratif Pierre
Hidden-drain pedestals are available on order in the same material and with the same finish as that used for the wash basin. / Los embellecedores del desagüe pueden realizarse bajo pedido con el mismo material y acabado que el lavabo. / Sur demande, les éléments décoratifs du drain peuvent être fabriqués dans le même matériel et avec les mêmes finitions que le lavabo.
(See page / Ver página / Voir page 139).

Maya



Description	Format	Codes	Group	Pcs	m2	Kg
Beige Classico	70x45x12.2 cm	100046874	G-182	1 x Cj	-	80 x Cj
	27 9/16x17 11/16x4 13/16"	L171801004		1 x Pal	-	56 Neto
Blanco Almeria Classico	70x45x12.2 cm	100046908	G-182	1 x Cj	-	80 x Cj
	27 9/16x17 11/16x4 13/16"	L171301063		1 x Pal	-	56 Neto
Persian White Classico	70x45x12.2 cm	100177084	G-182	1 x Cj	-	80 x Cj
	27 9/16x17 11/16x4 13/16"	L179702886		1 x Pal	-	56 Neto
Habana Dark Classico	70x45x12.2 cm	100068905	G-182	1 x Cj	-	80 x Cj
	27 9/16x17 11/16x4 13/16"	L170302378		1 x Pal	-	56 Neto
Crema Italia Classico	70x45x12.2 cm	100046872	G-182	1 x Cj	-	80 x Cj
	27 9/16x17 11/16x4 13/16"	L171801003		1 x Pal	-	56 Neto
Grey Stone Classico	70x45x12.2 cm	100003572	G-182	1 x Cj	-	80 x Cj
	27 9/16x17 11/16x4 13/16"	L171801001		1 x Pal	-	56 Neto

Qmax L/min=12 l/min (Pressure/Presión/Pression= 3 bar).

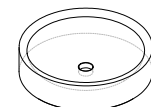
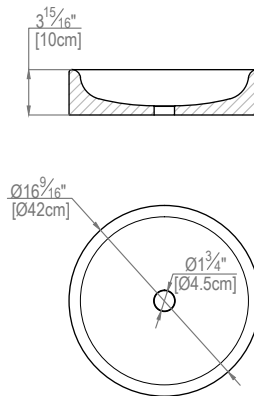

The set includes / El conjunto incluye / L'ensemble comprend les éléments suivants:
-Wash basin / Lavabo / Lavabo.



Casquillo Desagüe 2Cm Cromo
100043169 - N899393001
NOKEN



Vaciador Fijo Sin Rebosadero Cromo
100040383 - N299606001
NOKEN

Round



Description	Format	Codes	Group	Pcs	m2	Kg
Beige Classico	42x10 cm	100092832	G-178	1 x Cj	-	25 x Cj
	16 9/16"x16 9/16"x3 15/16"	L171301191		6 x Pal	-	21 Neto
Blanco Almeria Classico	42x10 cm	100092828	G-178	1 x Cj	-	25 x Cj
	16 9/16"x16 9/16"x3 15/16"	L171301184		6 x Pal	-	21 Neto
Persian White Classico	42x10 cm	100177075	G-178	1 x Cj	-	25 x Cj
	16 9/16"x16 9/16"x3 15/16"	L170302907		6 x Pal	-	21 Neto
Habana Dark Classico	42x10 cm	100092840	G-178	1 x Cj	-	25 x Cj
	16 9/16"x16 9/16"x3 15/16"	L171301192		6 x Pal	-	21 Neto
Crema Italia Classico	42x10 cm	100092829	G-178	1 x Cj	-	25 x Cj
	16 9/16"x16 9/16"x3 15/16"	L171301183		6 x Pal	-	21 Neto
Grey Stone Classico	42x10 cm	100092841	G-178	1 x Cj	-	25 x Cj
	16 9/16"x16 9/16"x3 15/16"	L171301195		6 x Pal	-	21 Neto

Qmax L/min=12 l/min (Pressure/Presión/Pression= 3 bar).

WASHBASIN / LAVABOS / LAVABOS

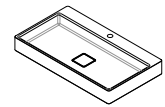
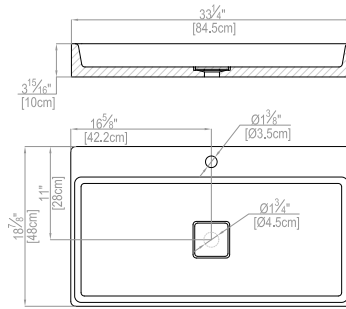

The set includes / El conjunto incluye / L'ensemble comprend les éléments suivants:
 -Wash basin / Lavabo / Lavabo.
 -Stone waste cover / Embellecedor piedra / Élément décoratif Pierre.

Basic H84



Description	Format	Codes	Group	Pcs	m2	Kg
Beige Classico	84,5x48x10 cm	100146408	G-185	1 x Cj	-	84 x Cj
	33 1/4"x18 7/8"x3 15/16"	L179702396		1 x Pal	-	58 Neto
Blanco Almeria Classico	84,5x48x10 cm	100146405	G-185	1 x Cj	-	84 x Cj
	33 1/4"x18 7/8"x3 15/16"	L179702391		1 x Pal	-	58 Neto
Persian White Classico	84,5x48x10 cm	100177090	G-185	1 x Cj	-	84 x Cj
	33 1/4"x18 7/8"x3 15/16"	L179702883		1 x Pal	-	58 Neto
Habana Dark Classico	84,5x48x10 cm	100146407	G-185	1 x Cj	-	84 x Cj
	33 1/4"x18 7/8"x3 15/16"	L179702393		1 x Pal	-	58 Neto
Crema Italia Classico	84,5x48x10 cm	100146410	G-185	1 x Cj	-	84 x Cj
	33 1/4"x18 7/8"x3 15/16"	L179702395		1 x Pal	-	58 Neto
Grey Stone Classico	84,5x48x10 cm	100146409	G-185	1 x Cj	-	84 x Cj
	33 1/4"x18 7/8"x3 15/16"	L179702397		1 x Pal	-	58 Neto

Qmax L/min=12 l/min (Pressure/Presión/Pression= 3 bar).



Casquillo Desagüe 2Cm Cromo
 100043169 - N899393001
 NOKEN



Vaciador Fijo Sin Rebosadero Cromo
 100040383 - N299606001
 NOKEN

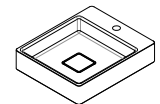
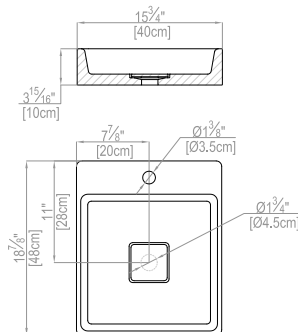

The set includes / El conjunto incluye / L'ensemble comprend les éléments suivants:
 -Wash basin / Lavabo / Lavabo.
 -Stone waste cover / Embellecedor piedra / Élément décoratif Pierre.

Basic H40



Description	Format	Codes	Group	Pcs	M2	Kg
Beige Classico	40x48x10 cm	100146400	G-183	1 x Cj	-	32 x Cj
	33 1/4"x18 7/8"x3 15/16"	L179702440		1 x Pal	-	28 Neto
Blanco Almeria Classico	40x48x10 cm	100146347	G-183	1 x Cj	-	32 x Cj
	33 1/4"x18 7/8"x3 15/16"	L179702425		1 x Pal	-	28 Neto
Persian White Classico	40x48x10 cm	100177039	G-183	1 x Cj	-	32 x Cj
	33 1/4"x18 7/8"x3 15/16"	L179702882		1 x Pal	-	28 Neto
Habana Dark Classico	40x48x10 cm	100146349	G-183	1 x Cj	-	32 x Cj
	33 1/4"x18 7/8"x3 15/16"	L179702411		1 x Pal	-	28 Neto
Crema Italia Classico	40x48x10 cm	100146402	G-183	1 x Cj	-	32 x Cj
	33 1/4"x18 7/8"x3 15/16"	L179702410		1 x Pal	-	28 Neto
Grey Stone Classico	40x48x10 cm	100146401	G-183	1 x Cj	-	32 x Cj
	33 1/4"x18 7/8"x3 15/16"	L179702457		1 x Pal	-	28 Neto

Qmax L/min=12 l/min (Pressure/Presión/Pression= 3 bar).



Casquillo Desagüe 2Cm Cromo
 100043169 - N899393001
 NOKEN



Vaciador Fijo Sin Rebosadero Cromo
 100040383 - N299606001
 NOKEN

WASHBASIN / LAVABOS / LAVABOS

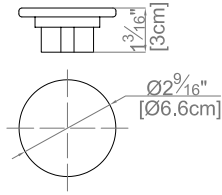

Embellecedor Lavabo



MATT



BIOPROT

Description	Format	Codes	Group	Pcs	m2	Kg
Beige Classico	6,6x3 cm 2 9/16" x1 3/16"	100155002 LI79702537	G-163	1 x Cj 50 x Pal	- -	3,10 x Cj 155,25 x Pal
Blanco Almeria Classico	6,6x3 cm 2 9/16" x1 3/16"	100154997 LI79702529	G-163	1 x Cj 50 x Pal	- -	3,10 x Cj 155,25 x Pal
Persian White Classico	6,6x3 cm 2 9/16" x1 3/16"	100177129 LI79702890	G-163	1 x Cj 50 x Pal	- -	3,10 x Cj 155,25 x Pal
Habana Dark Classico	6,6x3 cm 2 9/16" x1 3/16"	100155005 LI79702532	G-163	1 x Cj 50 x Pal	- -	3,10 x Cj 155,25 x Pal
Crema Italia Classico	6,6x3 cm 2 9/16" x1 3/16"	100155000 LI79702524	G-163	1 x Cj 50 x Pal	- -	3,10 x Cj 155,25 x Pal
Grey Stone Classico	6,6x3 cm 2 9/16" x1 3/16"	100155003 LI79702527	G-163	1 x Cj 50 x Pal	- -	3,10 x Cj 155,25 x Pal



Complementary products Shape Crema Italia



Complementary products Basic Stand Persian White, Basic Persian White



SHOWER TRAYS PLATOS DE DUCHA RECEVEURS DE DOUCHE

.....

Samui
Essence
Basic
Zen

SHOWER TRAYS / PLATOS DE DUCHA / RECEVEURS DE DOUCHE

Bathrooms

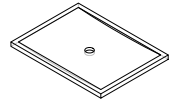
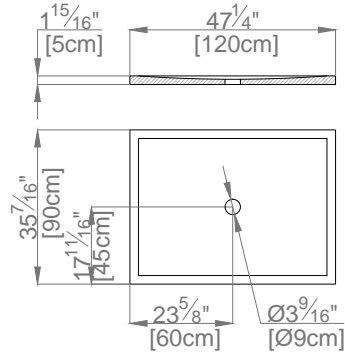

The set includes / El conjunto incluye / L'ensemble comprend les éléments suivants:
-Shower tray / Plato de ducha / Receveur de douche.

Samui



Kit Desagüe S/Pip. Project D.90 Cromo
100060526 - S904410002
SYSTEMPOOL

Description	Format	Codes	Group	Pcs	m2	Kg
Beige Classico	120x90x5 cm 47 1/4"x35 7/16"x1 15/16"	100068936 L173202020	G-185	1 x Cj 1 x Pal	-	174 x Cj 123 Neto
Blanco Almeria Classico	120x90x5 cm 47 1/4"x35 7/16"x1 15/16"	100068931 L173202023	G-185	1 x Cj 1 x Pal	-	174 x Cj 123 Neto
Persian White Classico	120x90x5 cm 47 1/4"x35 7/16"x1 15/16"	100177160 L173300469	G-185	1 x Cj 1 x Pal	-	174 x Cj 123 Neto
Habana Dark Classico	120x90x5 cm 47 1/4"x35 7/16"x1 15/16"	100057403 L173300082	G-185	1 x Cj 1 x Pal	-	174 x Cj 123 Neto
Crema Italia Classico	120x90x5 cm 47 1/4"x35 7/16"x1 15/16"	100068932 L173202021	G-185	1 x Cj 1 x Pal	-	174 x Cj 123 Neto
Grey Stone Classico	120x90x5 cm 47 1/4"x35 7/16"x1 15/16"	100068933 L173202022	G-185	1 x Cj 1 x Pal	-	174 x Cj 123 Neto



Stone waste cover / Embellecedor Piedra / Élément Décoratif Pierre

Hidden-drain pedestals are available on order in the same material and with the same finish as that used for the shower tray. / Los embellecedores del desagüe pueden realizarse bajo pedido con el mismo material y acabado que el plato de ducha. / Sur demande, les éléments décoratifs du drain peuvent être fabriqués dans le même matériel et avec les mêmes finitions que le receveur de douche. (See page / Ver página / Voir page 144).

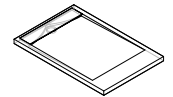
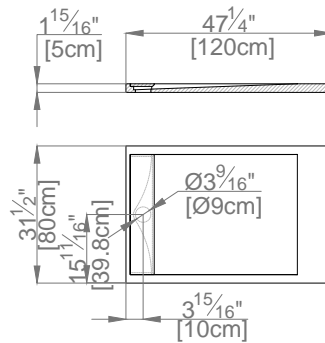

The set includes / El conjunto incluye / L'ensemble comprend les éléments suivants:
-Shower tray / Plato de ducha / Receveur de douche.

Essence



Kit Desagüe S/Pip. Project D.90 Cromo
100060526 - S904410002
SYSTEMPOOL

Description	Format	Codes	Group	Pcs	m2	Kg
Beige Classico	120x80x5 cm 47 1/4"x31 1/2"x1 15/16"	100032061 L179702036	G-186	1 x Cj 1 x Pal	-	172 x Cj 121 Neto
Blanco Almeria Classico	120x80x5 cm 47 1/4"x31 1/2"x1 15/16"	100032057 L179702021	G-186	1 x Cj 1 x Pal	-	172 x Cj 121 Neto
Persian White Classico	120x80x5 cm 47 1/4"x31 1/2"x1 15/16"	100177117 L173300467	G-186	1 x Cj 1 x Pal	-	172 x Cj 121 Neto
Habana Dark Classico	120x80x5 cm 47 1/4"x31 1/2"x1 15/16"	100068930 L173500004	G-186	1 x Cj 1 x Pal	-	172 x Cj 121 Neto
Crema Italia Classico	120x80x5 cm 47 1/4"x31 1/2"x1 15/16"	100032060 L179702026	G-186	1 x Cj 1 x Pal	-	172 x Cj 121 Neto
Grey Stone Classico	120x80x5 cm 47 1/4"x31 1/2"x1 15/16"	100068929 L173500002	G-186	1 x Cj 1 x Pal	-	172 x Cj 121 Neto

SHOWER TRAYS / PLATOS DE DUCHA / RECEVEURS DE DOUCHE

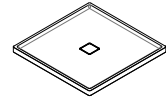
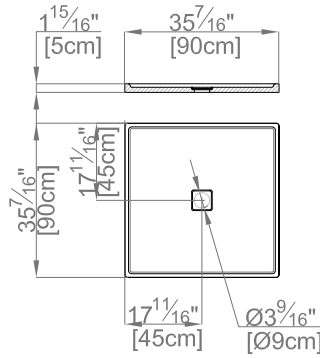

The set includes / El conjunto incluye / L'ensemble comprend les éléments suivants:
 -Shower tray / Plato de ducha / Receveur de douche.
 -Stone waste cover / Embellecedor piedra / Élément décoratif Pierre.



Kit Desagüe S/Pip. Project D.90 Cromo
 100060526 - S904410002
 SYSTEMPOOL

Basic



Description	Format	Codes	Group	Pcs	m2	Kg
Beige Classico	90x90x5 cm	100146416	G-188	1 x Cj	-	127 x Cj
	35 7/16"x35 7/16"x1 15/16"	L173300373		1 x Pal	-	76 Neto
Blanco Almeria Classico	90x90x5 cm	100146413	G-188	1 x Cj	-	127 x Cj
	35 7/16"x35 7/16"x1 15/16"	L173300374		1 x Pal	-	76 Neto
Persian White Classico	90x90x5 cm	100177136	G-188	1 x Cj	-	127 x Cj
	35 7/16"x35 7/16"x1 15/16"	L179702919		1 x Pal	-	76 Neto
Habana Dark Classico	90x90x5 cm	100146415	G-188	1 x Cj	-	127 x Cj
	35 7/16"x35 7/16"x1 15/16"	L173300375		1 x Pal	-	76 Neto
Crema Italia Classico	90x90x5 cm	100146421	G-188	1 x Cj	-	127 x Cj
	35 7/16"x35 7/16"x1 15/16"	L173300377		1 x Pal	-	76 Neto
Grey Stone Classico	90x90x5 cm	100146420	G-188	1 x Cj	-	127 x Cj
	35 7/16"x35 7/16"x1 15/16"	L173300380		1 x Pal	-	76 Neto

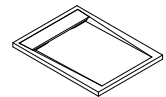
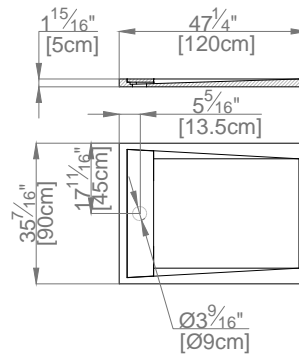

The set includes / El conjunto incluye / L'ensemble comprend les éléments suivants:
 -Shower tray / Plato de ducha / Receveur de douche.



Kit Desagüe S/Pip. Project D.90 Cromo
 100060526 - S904410002
 SYSTEMPOOL

Zen



Description	Format	Codes	Group	Pcs	m2	Kg
Beige Classico	120x90x5 cm	100174208	G-188	1 x Cj	-	176 x Cj
	47 1/4"x35 7/16"x1 15/16"	L173300460		1 x Pal	-	125 Neto
Blanco Almeria Classico	120x90x5 cm	100174423	G-188	1 x Cj	-	176 x Cj
	47 1/4"x35 7/16"x1 15/16"	L173300458		1 x Pal	-	125 Neto
Persian White Classico	120x90x5 cm	100177170	G-188	1 x Cj	-	176 x Cj
	47 1/4"x35 7/16"x1 15/16"	L173300468		1 x Pal	-	125 Neto
Habana Dark Classico	120x90x5 cm	100174426	G-188	1 x Cj	-	176 x Cj
	47 1/4"x35 7/16"x1 15/16"	L173300463		1 x Pal	-	125 Neto
Crema Italia Classico	120x90x5 cm	100174427	G-188	1 x Cj	-	176 x Cj
	47 1/4"x35 7/16"x1 15/16"	L173300462		1 x Pal	-	125 Neto
Grey Stone Classico	120x90x5 cm	100174425	G-188	1 x Cj	-	176 x Cj
	47 1/4"x35 7/16"x1 15/16"	L173300461		1 x Pal	-	125 Neto

SHOWER TRAYS / PLATOS DE DUCHA / RECEVEURS DE DOUCHE

Bathrooms

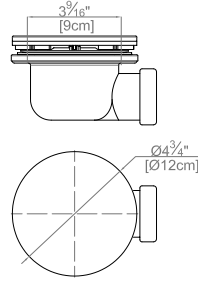







Embellecedores Piedra



MATT



BIOPROT

Description	Format	Codes	Group	Pcs	m2	Kg
 Beige Classico	ø 12 cm ø 4 3/4"	100092781 L179702065	G-163	1 x Cj 50 x Pal	- -	3,10 x Cj 155,25 x Pal
 Blanco Almeria Classico	ø 12 cm ø 4 3/4"	100092773 L179702064	G-163	1 x Cj 50 x Pal	- -	3,10 x Cj 155,25 x Pal
 Persian White Classico	ø 12 cm ø 4 3/4"	100177140 L179702911	G-163	1 x Cj 50 x Pal	- -	3,10 x Cj 155,25 x Pal
 Habana Dark Classico	ø 12 cm ø 4 3/4"	100092779 L179702069	G-163	1 x Cj 50 x Pal	- -	3,10 x Cj 155,25 x Pal
 Crema Italia Classico	ø 12 cm ø 4 3/4"	100092775 L179702070	G-163	1 x Cj 50 x Pal	- -	3,10 x Cj 155,25 x Pal
 Grey Stone Classico	ø 12 cm ø 4 3/4"	100092777 L179702073	G-163	1 x Cj 50 x Pal	- -	3,10 x Cj 155,25 x Pal

SHOWER TRAYS / PLATOS DE DUCHA / RECEVEURS DE DOUCHE



Floor Coverings Nepal Natural / Wall Coverings Nepal Natural / Complementary products Samui Persian White



Floor Coverings Paradise Baia Stone Blanco / Complementary products Conjunto Zen Crema Italia / Nogal Intense, Samara Crema Italia

BATHTUBS BAÑERAS BAIGNOIRES

.....

Samara
Khoa
Future



BATHTUBS / BAÑERAS / BAIGNOIRES

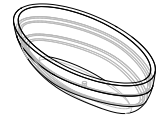
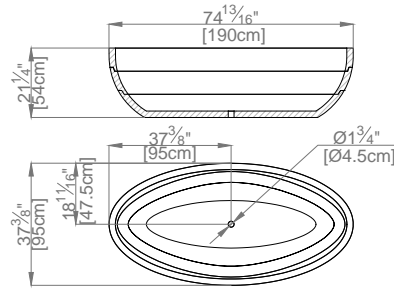

The set includes / El conjunto incluye / L'ensemble comprend les éléments suivants:
 -Bathtub / Bañera / Baignoires.
 -Installation kit / Kit de instalación / Kit d'installation.
 -Gasket / Junta de montaje / Joint de montage.
 -Maintenance kit / Kit de mantenimiento / Kit d'entretien.

Samara



Vaciador Pulsador Cliker Sin Rebosadero
 100110743 - N698350001
 NOKEN

Description	Format	Codes	Group	Pcs	m2	Kg
Persian White Classico	190x95x54 cm	100177312	G-199	1 x Cj	-	653 x Cj
	74 13/16"x37 3/8"x21 1/4"	L173300471		1 x Pal	-	503 Neto
Crema Italia Classico	190x95x54 cm	100177306	G-198	1 x Cj	-	580 x Cj
	74 13/16"x37 3/8"x21 1/4"	L173300470		1 x Pal	-	430 Neto
Habana Dark Classico	190x95x54 cm	100177307	G-199	1 x Cj	-	653 x Cj
	74 13/16"x37 3/8"x21 1/4"	L173300473		1 x Pal	-	503 Neto



Stone waste cover / Embellecedor Piedra / Élément Décoratif Pierre
 Hidden-drain pedestals are available on order in the same material and with the same finish as that used for the bathtubs. / Los embellecedores del desagüe pueden realizarse bajo pedido con el mismo material y acabado que la bañera. / Sur demande, les éléments décoratifs du drain peuvent être fabriqués dans le même matériel et avec les mêmes nitions que le baignoires.
 (See page / Ver página / Voir page 149).

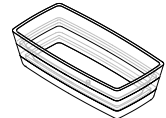
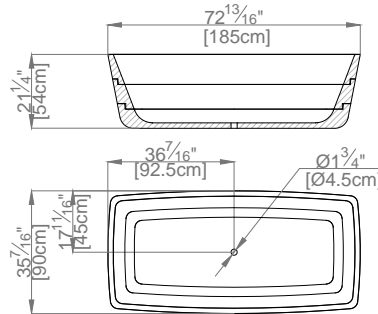

The set includes / El conjunto incluye / L'ensemble comprend les éléments suivants:
 -Bathtub / Bañera / Baignoires.
 -Installation kit / Kit de instalación / Kit d'installation.
 -Gasket / Junta de montaje / Joint de montage.
 -Maintenance kit / Kit de mantenimiento / Kit d'entretien.

Khoa



Vaciador Pulsador Cliker Sin Rebosadero
 100110743 - N698350001
 NOKEN

Description	Format	Codes	Group	Pcs	m2	Kg
Persian White Classico	185x90x54 cm	100177311	G-199	1 x Cj	-	675 x Cj
	72 13/16"x35 7/16"x21 1/4"	L179702923		1 x Pal	-	525 Neto
Crema Italia Classico	185x90x54 cm	100177310	G-198	1 x Cj	-	600 x Cj
	72 13/16"x35 7/16"x21 1/4"	L179702936		1 x Pal	-	450 Neto
Habana Dark Classico	185x90x54 cm	100177305	G-199	1 x Cj	-	675 x Cj
	72 13/16"x35 7/16"x21 1/4"	L179702924		1 x Pal	-	525 Neto



Stone waste cover / Embellecedor Piedra / Élément Décoratif Pierre
 Hidden-drain pedestals are available on order in the same material and with the same finish as that used for the bathtubs. / Los embellecedores del desagüe pueden realizarse bajo pedido con el mismo material y acabado que la bañera. / Sur demande, les éléments décoratifs du drain peuvent être fabriqués dans le même matériel et avec les mêmes nitions que le baignoires.
 (See page / Ver página / Voir page 149).

BATHTUBS / BAÑERAS / BAIGNOIRES

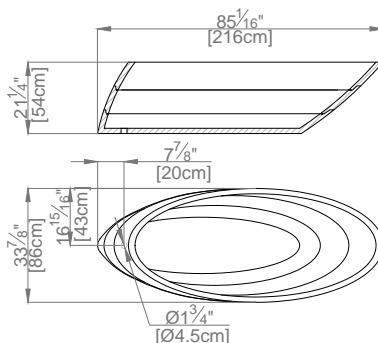

The set includes / El conjunto incluye / L'ensemble comprend les éléments suivants:
 -Bathtub / Bañera / Baignoires.
 -Installation kit / Kit de instalación / Kit d'installation.
 -Gasket / Junta de montaje / Joint de montage.
 -Maintenance kit / Kit de mantenimiento / Kit d'entretien.

Future



Vaciador Pulsador Cliker Sin Rebosadero
 100110743 - N698350001
 NOKEN

Description	Format	Codes	Group	Pcs	m2	Kg
Persian White Classico	216x86x54 cm 85 1/16"x33 7/8"x21 1/4"	100177279 L179702934	G-199	1 x Cj 1 x Pal	-	675 x Cj 525 Neto
Crema Italia Classico	216x86x54 cm 85 1/16"x33 7/8"x21 1/4"	100177278 L179702917	G-198	1 x Cj 1 x Pal	-	600 x Cj 450 Neto
Habana Dark Classico	216x86x54 cm 85 1/16"x33 7/8"x21 1/4"	100177304 L173300472	G-199	1 x Cj 1 x Pal	-	675 x Cj 525 Neto



Stone waste cover / Embellecedor Piedra / Élémt Décoratif Pierre
 Hidden-drain pedestals are available on order in the same material and with the same finish as that used for the bathtubs. / Los embellecedores del desagüe pueden realizarse bajo pedido con el mismo material y acabado que la bañera. / Sur demande, les éléments décoratifs du drain peuvent être fabriqués dans le même matériel et avec les mêmes nitions que le baignoires.
 (See page / Ver página / Voir page 149).

More baths can be found on pages 169, 179 and 225.

Pueden encontrar más modelos de bañeras en las páginas 169, 179 y 225.

Vous trouverez d'autres modèles de baignoires aux pages 169, 179 et 225.

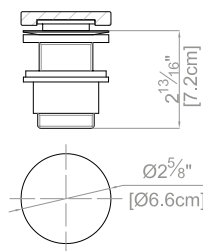

Embellecedores piedra



Description	Format	Codes	Group	Pcs	m2	Kg
Persian White Classico	ø6,6x7,2cm ø2 5/8"x2 13/16"	100177128 L179702891	G-163	1 x Cj 50 x Pal	-	3,10 x Cj 155,25 x Pal
Crema Italia Classico	ø6,6x7,2cm ø2 5/8"x2 13/16"	100154992 L179702534	G-163	1 x Cj 50 x Pal	-	3,10 x Cj 155,25 x Pal
Habana Dark Classico	ø6,6x7,2cm ø2 5/8"x2 13/16"	100154996 L179702535	G-163	1 x Cj 50 x Pal	-	3,10 x Cj 155,25 x Pal



Floor Coverings Linkfloor Hotel Air Silver / Wall Coverings Denia Blanco, Calpe Blanco, Javea Seagreen / Complementary products Vintage Crema Italia, Wood Top Nogal Warm, Hampton Nogal Warm, Boston Nogal Warm, Basic Persian White

WORKTOPS ENCIMERAS TABLETTES

.....

Natural Stone
Natural Wood



WORKTOPS / ENCIMERAS / TABLETTES

Bathrooms

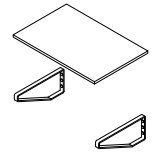
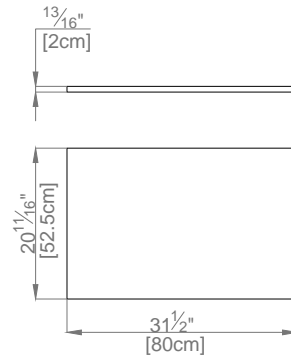

The set includes / El conjunto incluye / L'ensemble comprend les éléments suivants:
 -Countertop / Encimera / Tablettes.
 -Bracket / Escuadra de sujeción / Équerre de fixation.
 -Screws / Tornillería / Visserie.

Encimera 80x52,5x2 cm



Description	Format	Codes	Group	Pcs	m2	Kg
Blanco Almeria Classico	80x52.5x2 cm	100129000	G-173	1 x Cj	-	28 x Cj
	31 1/2"x20 11/16"x3/4"	L179702250		10 x Pal	-	23.50 Neto
Crema Italia Classico	80x52.5x2 cm	100129002	G-173	1 x Cj	-	27 x Cj
	31 1/2"x20 11/16"x3/4"	L179702256		10 x Pal	-	22.50 Neto
Moka Classico	80x52.5x2 cm	100129004	G-173	1 x Cj	-	26 x Cj
	31 1/2"x20 11/16"x3/4"	L179702254		10 x Pal	-	21.50 Neto
Pampa Home	80x52.5x2 cm	100129008	G-173	1 x Cj	-	26 x Cj
	31 1/2"x20 11/16"x3/4"	L172111101		10 x Pal	-	24.50 Neto
Tukiman Home	80x52.5x2 cm	100129014	G-173	1 x Cj	-	28 x Cj
	31 1/2"x20 11/16"x3/4"	L179702247		10 x Pal	-	23.50 Neto
Patagonia Home	80x52.5x2 cm	100129011	G-173	1 x Cj	-	27 x Cj
	31 1/2"x20 11/16"x3/4"	L179702245		10 x Pal	-	22.50 Neto
Bhutan Natural	80x52.5x2 cm	100128998	G-173	1 x Cj	-	26 x Cj
	31 1/2"x20 11/16"x3/4"	L179702253		10 x Pal	-	20.50 Neto

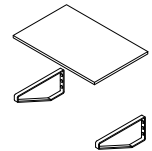
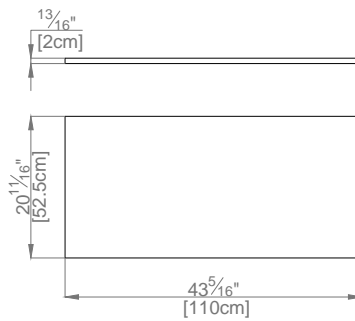

The set includes / El conjunto incluye / L'ensemble comprend les éléments suivants:
 -Countertop / Encimera / Tablettes.
 -Bracket / Escuadra de sujeción / Équerre de fixation.
 -Screws / Tornillería / Visserie.

Encimera 110x52,5x2 cm



Description	Format	Codes	Group	Pcs	m2	Kg
Pampa Home	110x52.5x2 cm	100129006	G-176	1 x Cj	-	37.50 x Cj
	43 5/16"x20 11/16"x3/4"	L172111061		1 x Pal	-	34 Neto
Tukiman Home	110x52.5x2 cm	100129012	G-176	1 x Cj	-	36.50 x Cj
	43 5/16"x20 11/16"x3/4"	L172111081		1 x Pal	-	32 Neto
Patagonia Home	110x52.5x2 cm	100129009	G-176	1 x Cj	-	35.50 x Cj
	43 5/16"x20 11/16"x3/4"	L172111071		1 x Pal	-	31 Neto
Bhutan Natural	110x52.5x2 cm	100128999	G-176	1 x Cj	-	32 x Cj
	43 5/16"x20 11/16"x3/4"	L172111091		1 x Pal	-	27.50 Neto

WORKTOPS / ENCIMERAS / TABLETTES

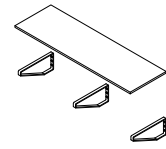
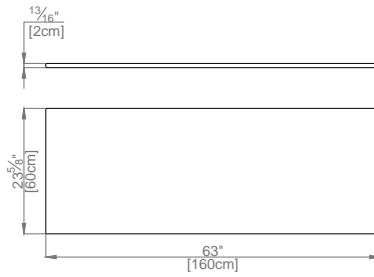

The set includes / El conjunto incluye / L'ensemble comprend les éléments suivants:
 -Countertop / Encimera / Tablettes.
 -Bracket / Escuadra de sujeción / Équerre de fixation.
 -Screws / Tornillería / Visserie.

Encimera 160x60x2 cm



Description	Format	Codes	Group	Pcs	m2	Kg
Pampa Home	160x60x2 cm	100129007	G-176	1 x Cj	-	61 x Cj
	63 1/2"x23 5/8"x3/4"	L172111051		1 x Pal	-	56,50 Neto
Tukuman Home	160x60x2 cm	100129013	G-176	1 x Cj	-	58 x Cj
	63 1/2"x23 5/8"x3/4"	L172111041		1 x Pal	-	53,50 Neto
Patagonia Home	160x60x2 cm	100129010	G-176	1 x Cj	-	55,50 x Cj
	63 1/2"x23 5/8"x3/4"	L172111021		1 x Pal	-	51 Neto

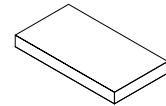
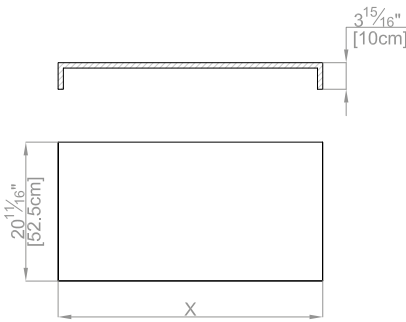

The set includes / El conjunto incluye / L'ensemble comprend les éléments suivants:
 -Countertop / Encimera / Tablettes.

Encimera Faldon MLx52,5x10 cm



Description	Format	Codes	Group	Pcs	m2	Kg
Persian White Classico	MLx52,5x10cm	Pedido Especial	G-175	-	-	-
	MLx20 11/16"x3 15/16"	Special Order		-	-	-
Habana Dark Classico	MLx52,5x10cm	Pedido Especial	G-175	-	-	-
	MLx20 11/16"x3 15/16"	Special Order		-	-	-
Crema Italia Classico	MLx52,5x10cm	Pedido Especial	G-175	-	-	-
	MLx20 11/16"x3 15/16"	Special Order		-	-	-
Grey Stone Classico	MLx52,5x10cm	Pedido Especial	G-175	-	-	-
	MLx20 11/16"x3 15/16"	Special Order		-	-	-

WORKTOPS / ENCIMERAS / TABLETTES

Bathrooms

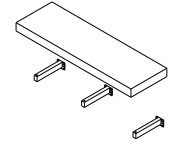
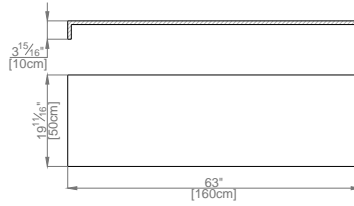

The set includes / El conjunto incluye / L'ensemble comprend les éléments suivants:
 -Countertop / Encimera / Tablettes.
 -Bracket / Escuadra de sujeción / Équerre de fixation.
 -Screws / Tornillería / Visserie.

Wood Top 160



Description	Format	Codes	Group	Pcs	m2	Kg
Nogal Intense	160x50x10	100114119	G-178	1 x Cj	-	17 x Cj
	63 1/2"x19 11/16"x3 15/16"	L172108791		1 x Pal	-	16 x Neto
Nogal Warm	160x50x10	100114122	G-178	1 x Cj	-	17 x Cj
	63 1/2"x19 11/16"x3 15/16"	L172108731		1 x Pal	-	16 x Neto

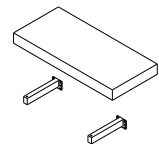
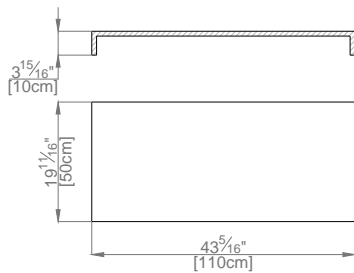

The set includes / El conjunto incluye / L'ensemble comprend les éléments suivants:
 -Countertop / Encimera / Tablettes.
 -Bracket / Escuadra de sujeción / Équerre de fixation.
 -Screws / Tornillería / Visserie.

Wood Top 110



Description	Format	Codes	Group	Pcs	m2	Kg
Nogal Intense	110x50x10	100114118	G-178	1 x Cj	-	12 x Cj
	43 5/16"x19 11/16"x3 15/16"	L172108771		1 x Pal	-	12 x Neto
Nogal Warm	110x50x10	100114121	G-178	1 x Cj	-	13 x Cj
	43 5/16"x19 11/16"x3 15/16"	L172108721		1 x Pal	-	13 x Neto

WORKTOPS / ENCIMERAS / TABLETTES

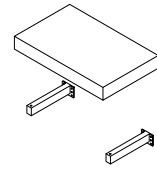
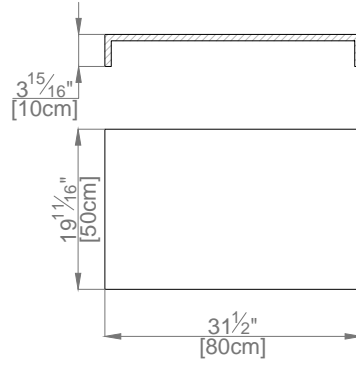



The set includes / El conjunto incluye / L'ensemble comprend les éléments suivants:
 -Countertop / Encimera / Tablettes.
 -Bracket / Escudra de sujeción / Équerre de fixation.
 -Screws / Tornillería / Visserie.

Bathrooms

Wood Top 80



MATT

Description	Format	Codes	Group	Pcs	m2	Kg
 Nogal Intense	80x50x10 cm	100114120	G-176	1 x Cj	-	10 x Cj
	31 1/2" x 19 1/16" x 3 15/16"	L172108781		1 x Pal	-	9 Neto
 Nogal Warm	80x50x10 cm	100114123	G-176	1 x Cj	-	10 x Cj
	31 1/2" x 19 1/16" x 3 15/16"	L172108811		1 x Pal	-	9 Neto



Wall Coverings Faces S3 Negro, Faces S4 Negro / Complementary products Faces Grey Stone, Wood Top Nogal Intense

WORKTOPS / ENCIMERAS / TABLETTES

Bathrooms

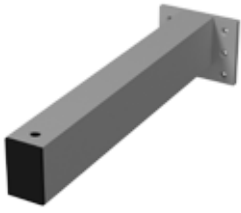

Soporte Encimera Recto

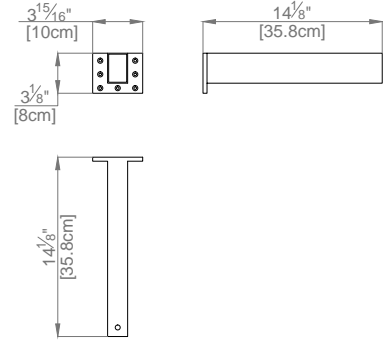

Soporte Encimera con Forma

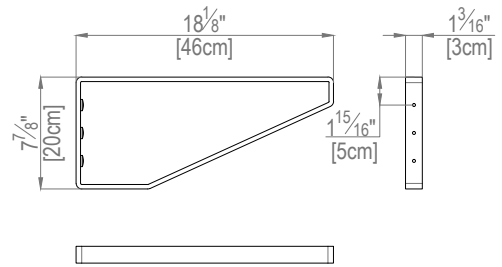

Soporte Encimera 70x47,5 cm

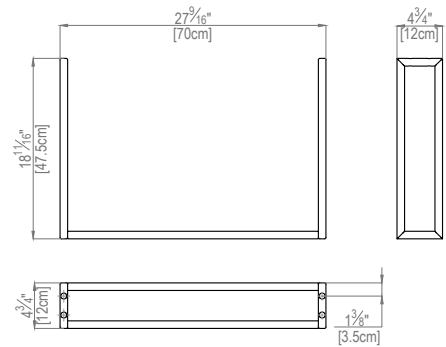

Soporte Encimera 150x55 cm

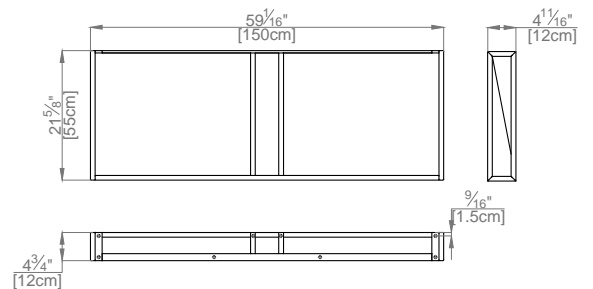

Description	Format	Codes	Group	Pcs	m2	Kg
Soporte Encimera Recto	35,8x8x10 cm 14 1/8"x3 1/8"x3 15/16"	100125549 LI09002091	G-165	1 x Cj 240 x Pal	- -	2 x Cj 1,5 Neto
Soporte Encimera Con Forma	46x20 cm 18 1/8"x7 7/8"	100153032 LI79702506	G-165	1 x Cj 160 x Pal	- -	3 x Cj 2,2 Neto
Soporte + Tornillos Encimera	70x47,5 cm 27 9/16"x18 11/16"	100151936 LI79702489	G-173	1 x Cj 20 x Pal	- -	5 x Cj 4,2 Neto
Soporte Encimera	150x55 cm 59"x21 5/8"	100059780 LI79702040	G-165	1 x Cj 5 x Pal	- -	8 x Cj 7,5 Neto

WORKTOPS / ENCIMERAS / TABLETTES

Examples of custom worktops / Ejemplos de encimeras a medida / exemples de tablettes personnalisés



*Special countertops do not include brackets / Las encimeras especiales no incluyen soportes / Les tablettes spéciales sont fournies sans supports



Floor Coverings Amsterdam Hexagon Grey / Wall Coverings Persian White Classico / Complementary products W-Tower Roble Cloudy

FURNITURE MUEBLES MEUBLES

.....

Hamptom
Boston
W-Tower



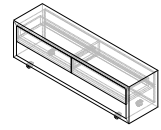
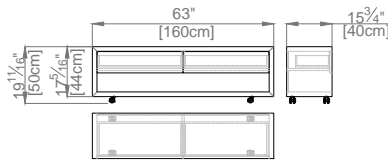

FURNITURE / MUEBLES / MEUBLES



The set includes / El conjunto incluye /
L'ensemble comprend les éléments suivants:
-Furniture / Mueble / Meuble.
-Screws / Tornillería / Visserie.
-Wheels / Ruedas / Roues.

Hampton





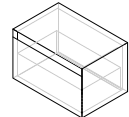
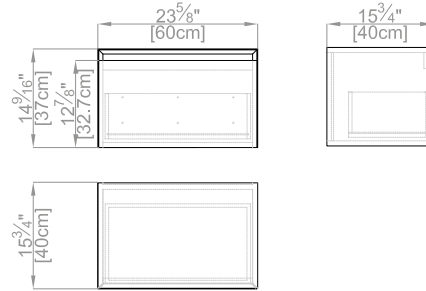

	Description	Format	Codes	Group	Pcs	m2	Kg
	Nogal Intense	160x44x40 cm 63"x17 3/8"x15 3/4"	I00081288 L175000012	G-184	1 x Cj 4 x Pal	-	72,45 x Cj 289,80 x Pal
	Nogal Warm	160x44x40 cm 63"x17 3/8"x15 3/4"	I00081289 L175000004	G-184	1 x Cj 4 x Pal	-	72,45 x Cj 289,80 x Pal



The set includes / El conjunto incluye /
L'ensemble comprend les éléments suivants:
-Furniture / Mueble / Meuble.
-Screws / Tornillería / Visserie.

W-Tower



	Description	Format	Codes	Group	Pcs	m2	Kg
	Nogal Intense	60x37x40 cm 23 5/8"x14 9/16"x15 3/4"	I00155860 L179702584	G-178	1 x Cj 1 x Pal	-	19,15 x Cj 18,50 Neto
	Roble Sunset	60x37x40 cm 23 5/8"x14 9/16"x15 3/4"	I00155875 L179702569	G-178	1 x Cj 1 x Pal	-	19,15 x Cj 18,50 Neto
	Nogal Warm	60x37x40 cm 23 5/8"x14 9/16"x15 3/4"	I00155865 L179702572	G-178	1 x Cj 1 x Pal	-	19,15 x Cj 18,50 Neto
	Roble Cloudy	60x37x40 cm 23 5/8"x14 9/16"x15 3/4"	I00155870 L179702576	G-178	1 x Cj 1 x Pal	-	19,15 x Cj 18,50 Neto

FURNITURE / MUEBLES / MEUBLES

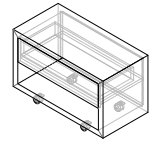
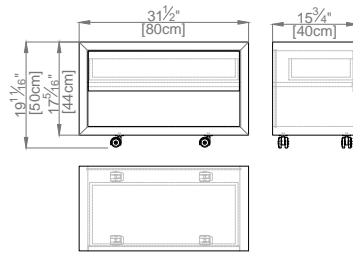



The set includes / El conjunto incluye /
L'ensemble comprend les éléments suivants:
-Furniture / Mueble / Meuble.
-Screws / Tornillería / Visserie.
-Wheels / Ruedas / Roues.

Bathrooms

Boston



MATT

Description	Format	Codes	Group	Pcs	m2	Kg
 Nogal Intense	80x44x40 cm 31 1/2"x17 3/8"x15 3/4"	I00153000 L175000084	G-181	1 x Cj 1 x Pal	- -	38,81 x Cj 38,81 x Pal
 Nogal Warm	80x44x40 cm 31 1/2"x17 3/8"x15 3/4"	I00153001 L175000081	G-181	1 x Cj 1 x Pal	- -	38,81 x Cj 38,81 x Pal



Floor Coverings Linkfloor Hotel Air Silver / Wall Coverings Javea Seagreen / Complementary products Boston Nogal Warm, Basic Persian White



Complementary products Conjunto Lavabo + Encimera + Plato de Ducha 90cm Crema Italia.



**COMPLETE
SETS
CONJUNTOS
COMPLETOS
ESEMBLES
COMPLETS**
.....

COMPLETE SETS / CONJUNTOS COMPLETOS / ENSEMBLES COMPLETS

Bathrooms

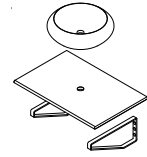
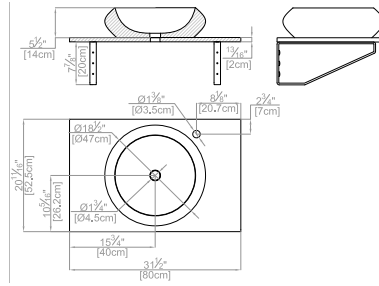

The set includes / El conjunto incluye / L'ensemble comprend les éléments suivants:
 -Wash basin / Lavabo / Lavabo.
 -Countertop / Encimera / Tablette.
 -Bracket / Escuadra de sujeción / Équerre de fixation.
 -Screws / Tornillería / Visserie.

Lavabo + Encimera Crema Italia



Casquillo Desagüe 2cm Cromo
 100043169 - N899393001
 NOKEN



Vaciador Fijo Sin Rebosadero Cromo
 100040383 - N299606001
 NOKEN

Description	Format	Codes	Group	Pcs	m2	Kg
Lavabo+Encimera Cr:Italia	-	100151804 LI79702484	G-181	-	-	64 x Cj 58.5 Neto

Qmax L/min=12 l/min (Pressure/Presión/Pression= 3 bar).

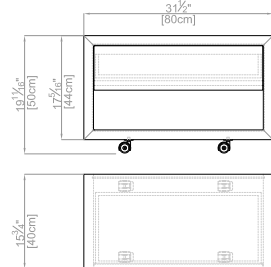
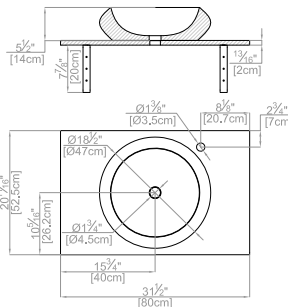

The set includes / El conjunto incluye / L'ensemble comprend les éléments suivants:
 -Wash basin / Lavabo / Lavabo.
 -Countertop / Encimera / Tablette.
 -Bracket / Escuadra de sujeción / Équerre de fixation.
 -Screws / Tornillería / Visserie.
 -Furniture / Mueble / Meuble.

Lavabo + Encimera + Boston



Casquillo Desagüe 2cm Cromo
 100043169 - N899393001
 NOKEN



Vaciador Fijo Sin Rebosadero Cromo
 100040383 - N299606001
 NOKEN

Description	Format	Codes	Group	Pcs	m2	Kg
Lavabo+Encimera+Boston Nogal Intense	-	100153725 LI70302865	G-184	-	-	102,81 x Cj 97,50 Neto
Lavabo+Encimera+Boston Nogal Warm	-	100153726 LI70302864	G-184	-	-	102,81 x Cj 97,50 Neto

Qmax L/min=12 l/min (Pressure/Presión/Pression= 3 bar).

COMPLETE SETS / CONJUNTOS COMPLETOS / ENSEMBLES COMPLETS

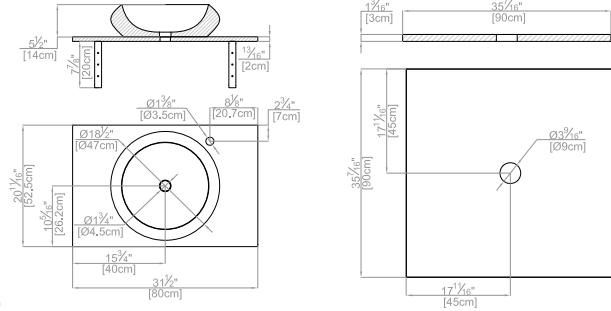

Lavabo + Encimera + P.ducha 90 Cr. Italia



The set includes / El conjunto incluye / L'ensemble comprend les éléments suivants:
 -Wash basin / Lavabo / Lavabo.
 -Countertop / Encimera / Tablettes.
 -Bracket / Escuadra de sujeción / Équerre de fixation.
 -Screws / Tornillería / Visserie.
 -Shower tray / Plato de ducha / Receveur de douche.

Description	Format	Codes	Group	Pcs	m2	Kg
Lavabo+Encimera+Pducha 90 Cr. Italia	-	100151803 LI79702486	G-184	-	-	223.81 x Cj 167.50 Neto

Qmax L/min=12 l/min (Pressure/Presión/Pression= 3 bar).



Casquillo Desagüe 2cm Cromo
100043169 - N899393001
NOKEN



Vaciador Fijo Sin Rebosadero Cromo
100040383 - N299606001
NOKEN



Kit Desagüe S/Pip. Project D.90 Cromo
100060526 - S904410002
SYSTEMPOOL

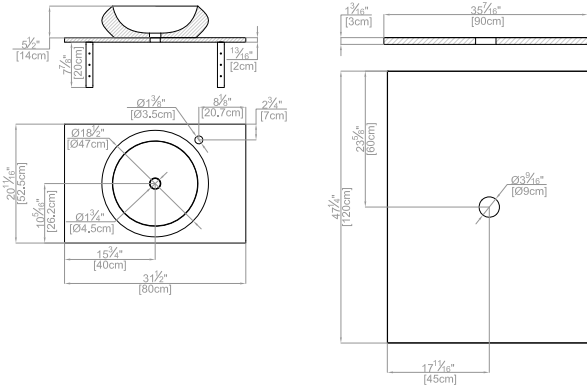

Lavabo + Encimera + P.ducha 120 Cr. Italia



The set includes / El conjunto incluye / L'ensemble comprend les éléments suivants:
 -Wash basin / Lavabo / Lavabo.
 -Countertop / Encimera / Tablettes.
 -Bracket / Escuadra de sujeción / Équerre de fixation.
 -Screws / Tornillería / Visserie.
 -Shower tray / Plato de ducha / Receveur de douche.

Description	Format	Codes	Group	Pcs	m2	Kg
Lavabo+Encimera+Pducha 120 Cr. Italia	-	100151802 LI79702485	G-184	-	-	244.81 x Cj 189.50 Neto

Qmax L/min=12 l/min (Pressure/Presión/Pression= 3 bar).



Casquillo Desagüe 2cm Cromo
100043169 - N899393001
NOKEN



Vaciador Fijo Sin Rebosadero Cromo
100040383 - N299606001
NOKEN



Kit Desagüe S/Pip. Project D.90 Cromo
100060526 - S904410002
SYSTEMPOOL



Complementary products Men{H}ir Crema Italia, Men{H}ir Encimera S Roble Antracita, Men{H}ir Mueble S Crema Italia-Roble Antracita, Men{H}ir Espejo Roble Antracita, Men{H}ir Estante Vertical I Roble Antracita, Men{h}ir Bañera Crema Italia Roble Antracita

MENHIR

.....

by EstudiHac

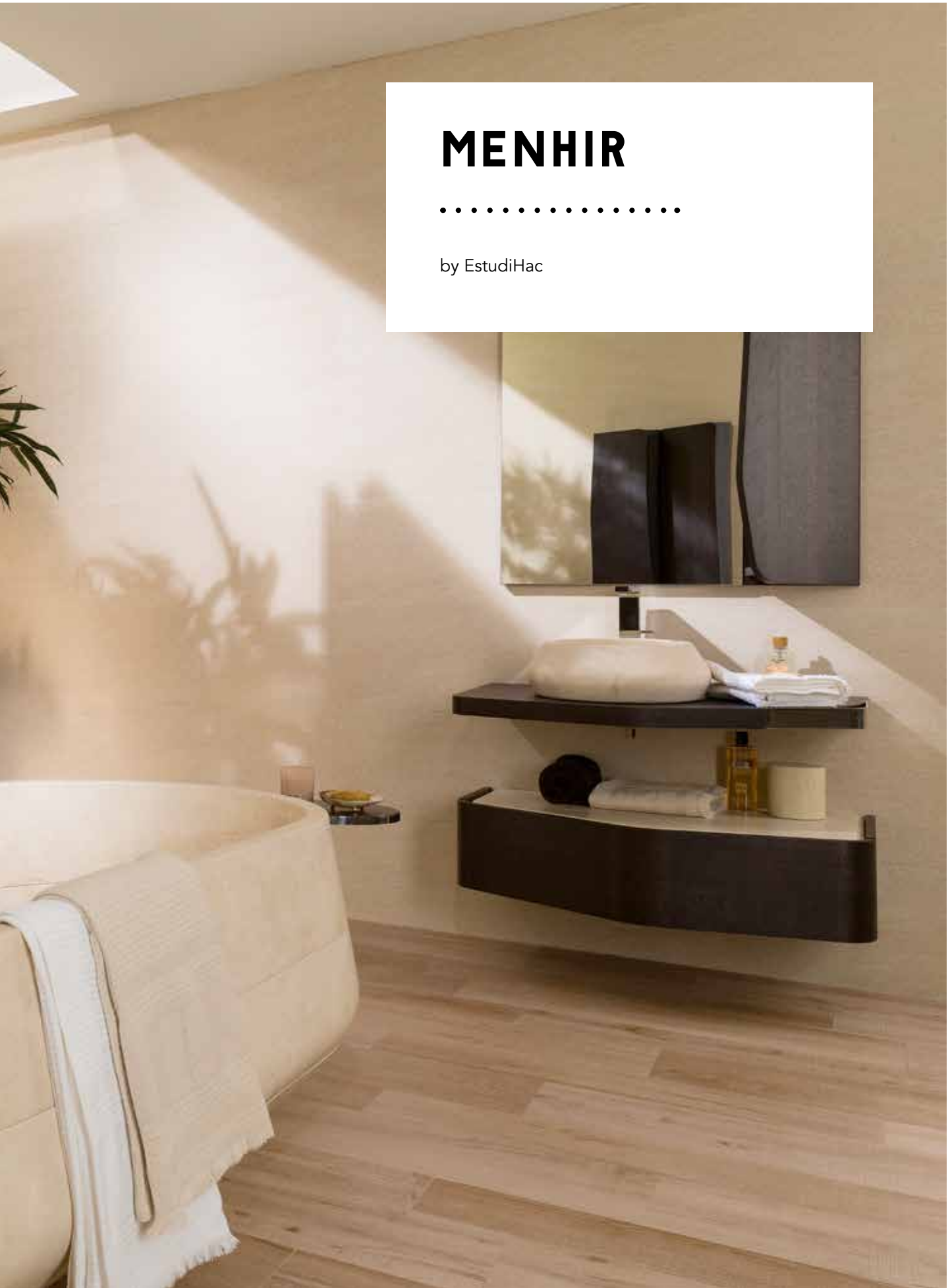

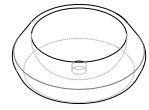
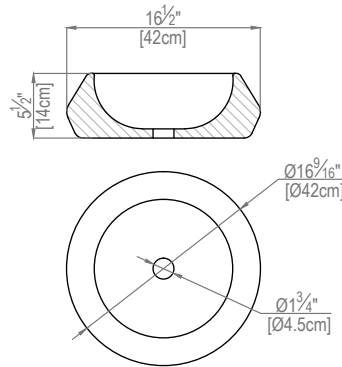

MENHIR



The set includes / El conjunto incluye / L'ensemble comprend les éléments suivants:
-Wash basin / Lavabo / Lavabo.

Men{H}ir



Description	Format	Codes	Group	Pcs	m2	Kg
 Persian White Classico	42x42x14 cm	I00177137	G-178	1 x Cj	-	31 x Cj
	16 9/16"x16 9/16"x5 1/2"	L179702893		6 x Pal	-	27 Neto
 Crema Italia Classico	42x42x14 cm	I00120627	G-178	1 x Cj	-	31 x Cj
	16 9/16"x16 9/16"x5 1/2"	L170302838		6 x Pal	-	27 Neto
 Habana Dark Classico	42x42x14 cm	I00161292	G-178	1 x Cj	-	31 x Cj
	16 9/16"x16 9/16"x5 1/2"	L179702679		6 x Pal	-	27 Neto

STOCK 2017

Qmax L/min= 12 l/min (Pressure/Presión/Pression= 3 bar).



Casquillo Desagüe 2Cm Cromo
I00043169 - N899393001
NOKEN



Vaciador Fijo Sin Rebosadero Cromo
I00040383 - N299606001
NOKEN





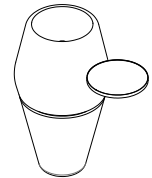
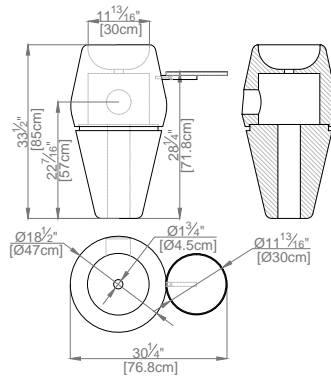





Stone waste cover / Embellecedor Piedra / Élément Décoratif Pierre
Hidden-drain pedestals are available on order in the same material and with the same finish as that used for the wash basin. / Los embellecedores del desagüe pueden realizarse bajo pedido con el mismo material y acabado que el lavabo. / Sur demande, les éléments décoratifs du drain peuvent être fabriqués dans le même matériel et avec les mêmes finitions que le lavabo.
(See page / Ver página / Voir page 139).



The set includes / El conjunto incluye / L'ensemble comprend les éléments suivants:
-Wash basin / Lavabo / Lavabo.
-Shelf / Estante / Etagère.
-Maintenance kit / Kit de mantenimiento / Kit d'entretien.

Men{H}ir Stand



Description	Format	Codes	Group	Pcs	m2	Kg
 Persian White / Roble Antracita	76,8x47x85 cm	I00177301	G-190	1 x Cj	-	195 x Cj
	30 1/4"x18 1/2"x33 1/2"	L179702926		1 x Pal	-	132 Neto
 Persian White / Roble Natural	76,8x47x85 cm	I00177284	G-190	1 x Cj	-	195 x Cj
	30 1/4"x18 1/2"x33 1/2"	L179702913		1 x Pal	-	132 Neto
 Persian White / Nogal Americano	76,8x47x85 cm	I00177300	G-190	1 x Cj	-	195 x Cj
	30 1/4"x18 1/2"x33 1/2"	L179702930		1 x Pal	-	132 Neto
 Crema Italia / Roble Antracita	76,8x47x85 cm	I00121770	G-190	1 x Cj	-	195 x Cj
	30 1/4"x18 1/2"x33 1/2"	L179702179		1 x Pal	-	132 Neto
 Crema Italia / Roble Natural	76,8x47x85 cm	I00120654	G-190	1 x Cj	-	195 x Cj
	30 1/4"x18 1/2"x33 1/2"	L179702160		1 x Pal	-	132 Neto
 Crema Italia / Nogal Americano	76,8x47x85 cm	I00161299	G-190	1 x Cj	-	195 x Cj
	30 1/4"x18 1/2"x33 1/2"	L179702678		1 x Pal	-	132 Neto
 Habana Dark / Roble Antracita	76,8x47x85 cm	I00161313	G-190	1 x Cj	-	195 x Cj
	30 1/4"x18 1/2"x33 1/2"	L179702704		1 x Pal	-	132 Neto
 Habana Dark / Roble Natural	76,8x47x85 cm	I00161308	G-190	1 x Cj	-	195 x Cj
	30 1/4"x18 1/2"x33 1/2"	L179702684		1 x Pal	-	132 Neto
 Habana Dark / Nogal Americano	76,8x47x85 cm	I00161314	G-190	1 x Cj	-	195 x Cj
	30 1/4"x18 1/2"x33 1/2"	L179702688		1 x Pal	-	132 Neto

Qmax L/min= 12 l/min (Pressure/Presión/Pression= 3 bar).



Casquillo Desagüe 2Cm Cromo
I00043169 - N899393001
NOKEN



Vaciador Fijo Sin Rebosadero Cromo
I00040383 - N299606001
NOKEN



Stone waste cover / Embellecedor Piedra / Élément Décoratif Pierre
Hidden-drain pedestals are available on order in the same material and with the same finish as that used for the wash basin. / Los embellecedores del desagüe pueden realizarse bajo pedido con el mismo material y acabado que el lavabo. / Sur demande, les éléments décoratifs du drain peuvent être fabriqués dans le même matériel et avec les mêmes finitions que le lavabo.
(See page / Ver página / Voir page 139).

MENHIR

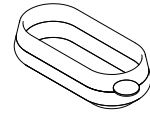
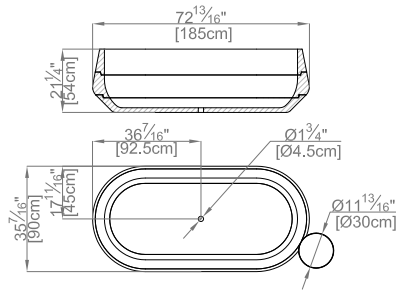

The set includes / El conjunto incluye / L'ensemble comprend les éléments suivants:
 -Bathtub / Bañera / Baignoires.
 -Installation kit / Kit de instalación / Kit d'installation.
 -Shelf / Estante / Etagère.
 -Gasket / Junta de montaje / Joint de montage.
 -Maintenance kit / Kit de mantenimiento / Kit d'entretien.

Bathrooms

Men{H}ir Bañera



Description	Format	Codes	Group	Pcs	m2	Kg
Persian White / Roble Antracita	185x90x54 cm	100177297	G-199	1 x Cj	-	775 x Cj
	72 13/16"x35 7/16"x21 1/4"	L179702904		1 x Pal	-	575 Neto
Persian White / Roble Natural	185x90x54 cm	100177314	G-199	1 x Cj	-	775 x Cj
	72 13/16"x35 7/16"x21 1/4"	L179702908		1 x Pal	-	575 Neto
Persian White / Nogal Americano	185x90x54 cm	100177287	G-199	1 x Cj	-	775 x Cj
	72 13/16"x35 7/16"x21 1/4"	L179702909		1 x Pal	-	575 Neto
Crema Italia / Roble Antracita	185x90x54 cm	100147973	G-199	1 x Cj	-	775 x Cj
	72 13/16"x35 7/16"x21 1/4"	L179702451		1 x Pal	-	575 Neto
Crema Italia / Roble Natural	185x90x54 cm	100146457	G-199	1 x Cj	-	775 x Cj
	72 13/16"x35 7/16"x21 1/4"	L179702448		1 x Pal	-	575 Neto
Crema Italia / Nogal Americano	185x90x54 cm	100161281	G-199	1 x Cj	-	775 x Cj
	72 13/16"x35 7/16"x21 1/4"	L179702658		1 x Pal	-	575 Neto
Habana Dark / Roble Antracita	185x90x54 cm	100161280	G-199	1 x Cj	-	775 x Cj
	72 13/16"x35 7/16"x21 1/4"	L179702655		1 x Pal	-	575 Neto
Habana Dark / Roble Natural	185x90x54 cm	100161290	G-199	1 x Cj	-	775 x Cj
	72 13/16"x35 7/16"x21 1/4"	L179702656		1 x Pal	-	575 Neto
Habana Dark / Nogal Americano	185x90x54 cm	100161291	G-199	1 x Cj	-	775 x Cj
	72 13/16"x35 7/16"x21 1/4"	L179702657		1 x Pal	-	575 Neto



Vaciador Pulsador Clikier Sin Rebosadero
 100110743 - N698350001
 NOKEN



Stone waste cover / Embellecedor Piedra / Élément Décoratif Pierre
 Hidden-drain pedestals are available on order in the same material and with the same finish as that used for the bathtubs. / Los embellecedores del desagüe pueden realizarse bajo pedido con el mismo material y acabado que la bañera. / Sur demande, les éléments décoratifs du drain peuvent être fabriqués dans le même matériel et avec les mêmes nitions que le baignoires.
 (See page / Ver página / Voir page 149).



Floor Coverings Eden Texture 1L Almond / Wall Coverings Arctic White Pulido / Complementary products Men{H}ir Bañera Crema Italia Roble Natural

MENHIR

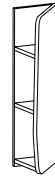
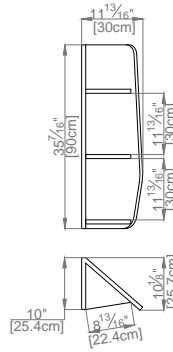

The set includes / El conjunto incluye /
L'ensemble comprend les éléments suivants:
-Shelf / Estante / Etagère.
-Screws / Tornillería / Visserie.

Men{H}ir Estante I



Description	Format	Codes	Group	Pcs	m2	Kg
Roble Antracita	90x30x25,7 cm 35 7/16"x11 13/16"x10 1/8"	100120599 L175000049	G-175	1 x Cj 4 x Pal	-	11 x Cj 7 Neto
Roble Natural	90x30x25,7 cm 35 7/16"x11 13/16"x10 1/8"	100120640 L175000053	G-175	1 x Cj 4 x Pal	-	11 x Cj 7 Neto
Nogal Americano	90x30x25,7 cm 35 7/16"x11 13/16"x10 1/8"	100161300 L179702694	G-175	1 x Cj 4 x Pal	-	11 x Cj 7 Neto

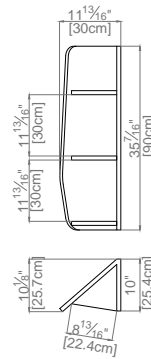

The set includes / El conjunto incluye /
L'ensemble comprend les éléments suivants:
-Shelf / Estante / Etagère.
-Screws / Tornillería / Visserie.

Men{H}ir Estante D



Description	Format	Codes	Group	Pcs	m2	Kg
Roble Antracita	90x30x25,7 cm 35 7/16"x11 13/16"x10 1/8"	100120598 L175000048	G-175	1 x Cj 4 x Pal	-	11 x Cj 7 Neto
Roble Natural	90x30x25,7 cm 35 7/16"x11 13/16"x10 1/8"	100120639 L175000055	G-175	1 x Cj 4 x Pal	-	11 x Cj 7 Neto
Nogal Americano	90x30x25,7 cm 35 7/16"x11 13/16"x10 1/8"	100161283 L179702690	G-175	1 x Cj 4 x Pal	-	11 x Cj 7 Neto

MENHIR

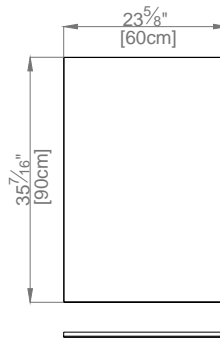

The set includes / El conjunto incluye /
L'ensemble comprend les éléments suivants:
-Mirrors / Espejo / Miroir.
-Screws / Tornillería / Visserie.

Men{H}ir Espejo



MATT

Description	Format	Codes	Group	Pcs	m2	Kg
Roble Antracita	90x60 cm 35 7/16"x23 5/8"	100153025 L175000082	G-173	1 x Cj 10 x Pal	- -	9,70 x Cj 5,70 Neto
Roble Natural	90x30x25,7 cm 35 7/16"x11 13/16"x10 1/8"	100153019 L175000083	G-173	1 x Cj 10 x Pal	- -	9,70 x Cj 5,70 Neto
Nogal Americano	90x60 cm 35 7/16"x23 5/8"	100161277 L179702674	G-173	1 x Cj 10 x Pal	- -	9,70 x Cj 5,70 Neto

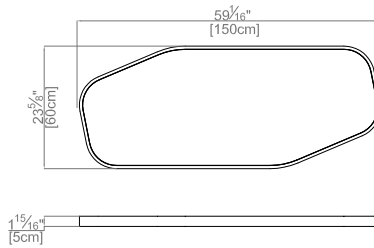

The set includes / El conjunto incluye /
L'ensemble comprend les éléments suivants:
-Mirrors / Espejo / Miroir.
-Screws / Tornillería / Visserie.

Men{H}ir Espejo L



MATT

Description	Format	Codes	Group	Pcs	m2	Kg
Roble Antracita	150x60x5 cm 59 1/16"x23 5/8"x1 15/16"	100146458 L175000070	G-175	1 x Cj 1 x Pal	- -	31,50 x Cj 26,50 Neto
Roble Natural	150x60x5 cm 59 1/16"x23 5/8"x1 15/16"	100146437 L175000069	G-175	1 x Cj 1 x Pal	- -	31,50 x Cj 26,50 Neto
Nogal Americano	150x60x5 cm 59 1/16"x23 5/8"x1 15/16"	100161238 L179702714	G-175	1 x Cj 1 x Pal	- -	31,50 x Cj 26,50 Neto

MENHIR

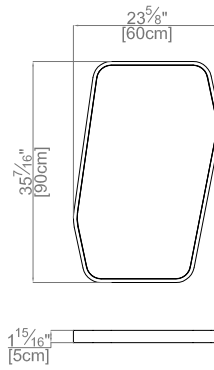

The set includes / El conjunto incluye /
L'ensemble comprend les éléments suivants:
-Mirrors / Espejo / Miroir.
-Screws / Tornillería / Visserie.

Men{H}ir Espejo S



Description	Format	Codes	Group	Pcs	m2	Kg
Roble Antracita	60x90x5 cm	100146438	G-173	1 x Cj	-	19 x Cj
	23 5/8"x35 7/16"x1 15/16"	L175000064		1 x Pal	-	14 Neto
Roble Natural	60x90x5 cm	100146439	G-173	1 x Cj	-	19 x Cj
	23 5/8"x35 7/16"x1 15/16"	L175000071		1 x Pal	-	14 Neto
Nogal Americano	60x90x5 cm	100161278	G-173	1 x Cj	-	19 x Cj
	23 5/8"x35 7/16"x1 15/16"	L179702713		1 x Pal	-	14 Neto

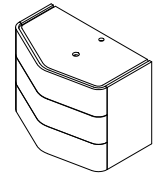
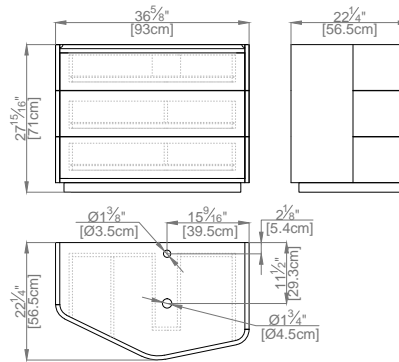

The set includes / El conjunto incluye /
L'ensemble comprend les éléments suivants:
-Furniture / Mueble / Meuble.
-Screws / Tornillería / Visserie.
-Stone countertop / Encimera de piedra /
Plan de toilette en pierre.

Men{H}ir Mueble S 3C



Description	Format	Codes	Group	Pcs	m2	Kg
Persian White / Roble Antracita	94x56,5x71 cm	100177293	G-192	1 x Cj	-	96 x Cj
	37"x22 1/4"x28"	L179702929		1 x Pal	-	61 Neto
Persian White / Roble Natural	94x56,5x71 cm	100177275	G-192	1 x Cj	-	96 x Cj
	37"x22 1/4"x28"	L179702935		1 x Pal	-	61 Neto
Persian White / Nogal Americano	94x56,5x71 cm	100177274	G-192	1 x Cj	-	96 x Cj
	37"x22 1/4"x28"	L179702927		1 x Pal	-	61 Neto
Crema Italia / Roble Antracita	94x56,5x71 cm	100146534	G-192	1 x Cj	-	96 x Cj
	37"x22 1/4"x28"	L175000078		1 x Pal	-	61 Neto
Crema Italia / Roble Natural	94x56,5x71 cm	100146504	G-192	1 x Cj	-	96 x Cj
	37"x22 1/4"x28"	L175000079		1 x Pal	-	61 Neto
Crema Italia / Nogal Americano	94x56,5x71 cm	100161285	G-192	1 x Cj	-	96 x Cj
	37"x22 1/4"x28"	L179702663		1 x Pal	-	61 Neto
Habana Dark / Roble Antracita	94x56,5x71 cm	100161294	G-192	1 x Cj	-	96 x Cj
	37"x22 1/4"x28"	L179702660		1 x Pal	-	61 Neto
Habana Dark / Roble Natural	94x56,5x71 cm	100161284	G-192	1 x Cj	-	96 x Cj
	37"x22 1/4"x28"	L179702661		1 x Pal	-	61 Neto
Habana Dark / Nogal Americano	94x56,5x71 cm	100161295	G-192	1 x Cj	-	96 x Cj
	37"x22 1/4"x28"	L179702662		1 x Pal	-	61 Neto

MENHIR

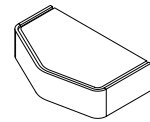
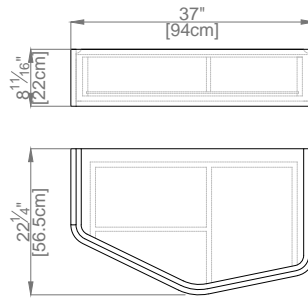

The set includes / El conjunto incluye /
L'ensemble comprend les éléments suivants:
-Furniture / Mueble / Meuble.
-Screws / Tornillería / Visserie.
-Stone countertop / Encimera de piedra /
Plan de toilette en pierre.

Men{H}ir Mueble S



Description	Format	Codes	Group	Pcs	m2	Kg
Persian White / Roble Antracita	94x56.5x22 cm 37"x22 1/4"x8 5/8"	100177267 L179702915	G-184	1 x Cj 1 x Pal	-	71 x Cj 48 Neto
Persian White / Roble Natural	94x56.5x22 cm 37"x22 1/4"x8 5/8"	100177268 L179702925	G-184	1 x Cj 1 x Pal	-	71 x Cj 48 Neto
Persian White / Nogal Americano	94x56.5x22 cm 37"x22 1/4"x8 5/8"	100177269 L179702912	G-184	1 x Cj 1 x Pal	-	71 x Cj 48 Neto
Crema Italia / Roble Antracita	94x56.5x22 cm 37"x22 1/4"x8 5/8"	100120648 L175000058	G-184	1 x Cj 1 x Pal	-	71 x Cj 48 Neto
Crema Italia / Roble Natural	94x56.5x22 cm 37"x22 1/4"x8 5/8"	100120649 L175000057	G-184	1 x Cj 1 x Pal	-	71 x Cj 48 Neto
Crema Italia / Nogal Americano	94x56.5x22 cm 37"x22 1/4"x8 5/8"	100161286 L179702669	G-184	1 x Cj 1 x Pal	-	71 x Cj 48 Neto
Habana Dark / Roble Antracita	94x56.5x22 cm 37"x22 1/4"x8 5/8"	100161305 L179702665	G-184	1 x Cj 1 x Pal	-	71 x Cj 48 Neto
Habana Dark / Roble Natural	94x56.5x22 cm 37"x22 1/4"x8 5/8"	100161312 L179702666	G-184	1 x Cj 1 x Pal	-	71 x Cj 48 Neto
Habana Dark / Nogal Americano	94x56.5x22 cm 37"x22 1/4"x8 5/8"	100161306 L179702668	G-184	1 x Cj 1 x Pal	-	71 x Cj 48 Neto

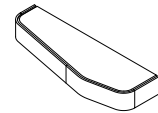
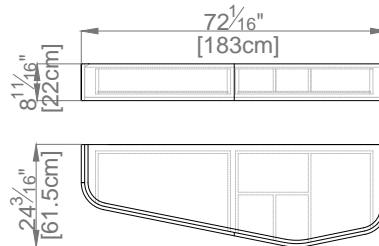

The set includes / El conjunto incluye /
L'ensemble comprend les éléments suivants:
-Furniture / Mueble / Meuble.
-Screws / Tornillería / Visserie.
-Stone countertop / Encimera de piedra /
Plan de toilette en pierre.

Men{H}ir Mueble L



Description	Format	Codes	Group	Pcs	m2	Kg
Persian White / Roble Antracita	183x59.5x22 cm 72 1/16"x23 7/16"x8 11/16"	100177273 L179702931	G-189	1 x Cj 1 x Pal	-	141 x Cj 90 Neto
Persian White / Roble Natural	183x59.5x22 cm 72 1/16"x23 7/16"x8 11/16"	100177266 L179702933	G-189	1 x Cj 1 x Pal	-	141 x Cj 90 Neto
Persian White / Nogal Americano	183x59.5x22 cm 72 1/16"x23 7/16"x8 11/16"	100177283 L179702918	G-189	1 x Cj 1 x Pal	-	141 x Cj 90 Neto
Crema Italia / Roble Antracita	183x59.5x22 cm 72 1/16"x23 7/16"x8 11/16"	100120629 L175000050	G-189	1 x Cj 1 x Pal	-	141 x Cj 90 Neto
Crema Italia / Roble Natural	183x59.5x22 cm 72 1/16"x23 7/16"x8 11/16"	100120647 L175000059	G-189	1 x Cj 1 x Pal	-	141 x Cj 90 Neto
Crema Italia / Nogal Americano	183x59.5x22 cm 72 1/16"x23 7/16"x8 11/16"	100161311 L179702682	G-189	1 x Cj 1 x Pal	-	141 x Cj 90 Neto
Habana Dark / Roble Antracita	183x59.5x22 cm 72 1/16"x23 7/16"x8 11/16"	100161310 L179702711	G-189	1 x Cj 1 x Pal	-	141 x Cj 90 Neto
Habana Dark / Roble Natural	183x59.5x22 cm 72 1/16"x23 7/16"x8 11/16"	100161302 L179702677	G-189	1 x Cj 1 x Pal	-	141 x Cj 90 Neto
Habana Dark / Nogal Americano	183x59.5x22 cm 72 1/16"x23 7/16"x8 11/16"	100161304 L179702706	G-189	1 x Cj 1 x Pal	-	141 x Cj 90 Neto

MENHIR

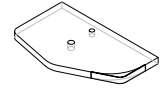
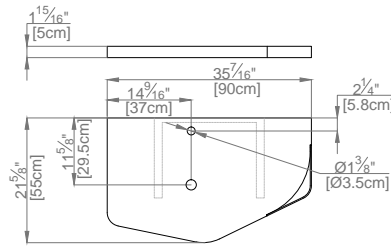

The set includes / El conjunto incluye / L'ensemble comprend les éléments suivants:
 -Countertop / Encimera / Tablette.
 -Bracket / Escuadras de sujeción / Équerre de fixation.
 -Screws / Tornillería / Visserie.

Men{H}ir Encimera S



Description	Format	Codes	Group	Pcs	m2	Kg
Roble Antracita	90x55x5 cm	100120628	G-175	1 x Cj	-	27.50 x Cj
	35 7/16"x21 5/8"x1 15/16"	L172109831		5 x Pal	-	20.50 Neto
Roble Natural	90x55x5 cm	100120634	G-175	1 x Cj	-	27.50 x Cj
	35 7/16"x21 5/8"x1 15/16"	L172109841		5 x Pal	-	20.50 Neto
Nogal Americano	90x55x5 cm	100161237	G-175	1 x Cj	-	27.50 x Cj
	35 7/16"x21 5/8"x1 15/16"	L172113701		5 x Pal	-	20.50 Neto

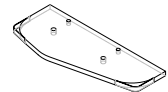
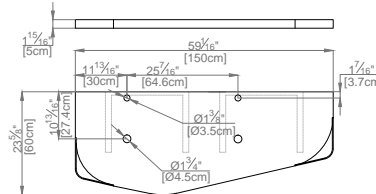

The set includes / El conjunto incluye / L'ensemble comprend les éléments suivants:
 -Countertop / Encimera / Tablette.
 -Bracket / Escuadras de sujeción / Équerre de fixation.
 -Screws / Tornillería / Visserie.

Men{H}ir Encimera L



Description	Format	Codes	Group	Pcs	m2	Kg
Roble Antracita	150x60x5 cm	100120596	G-183	1 x Cj	-	46.50 x Cj
	59 1/16"x23 5/8"x1 1/16"	L172109821		5 x Pal	-	37.50 Neto
Roble Natural	150x60x5 cm	100120643	G-183	1 x Cj	-	46.50 x Cj
	59 1/16"x23 5/8"x1 1/16"	L179702158		5 x Pal	-	37.50 Neto
Nogal Americano	150x60x5 cm	100161282	G-183	1 x Cj	-	46.50 x Cj
	59 1/16"x23 5/8"x1 1/16"	L179702659		5 x Pal	-	37.50 Neto

MENHIR



Complementary products Men{H}ir Persian White, Men{H}ir Encimera S Roble Roble Natural, Men{H}ir Mueble S Persian White-Roble Natural

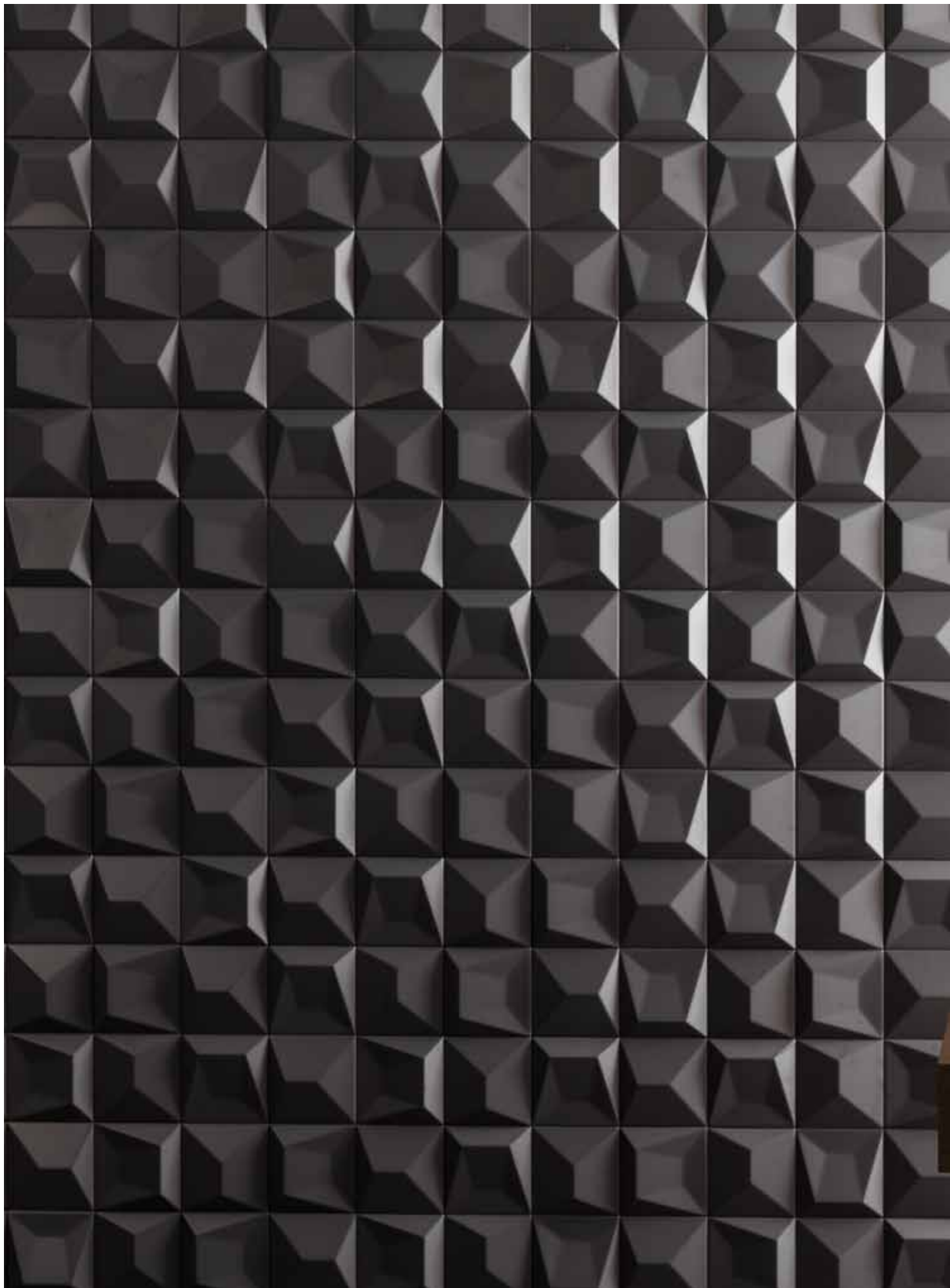

Wall Coverings Faces S3 Negro, Faces S4 Negro / Complementary products Faces Grey Stone, Wood Top Nogal Intense, Faces Espejo Vertical

FACES

.....

by Ramón Esteve

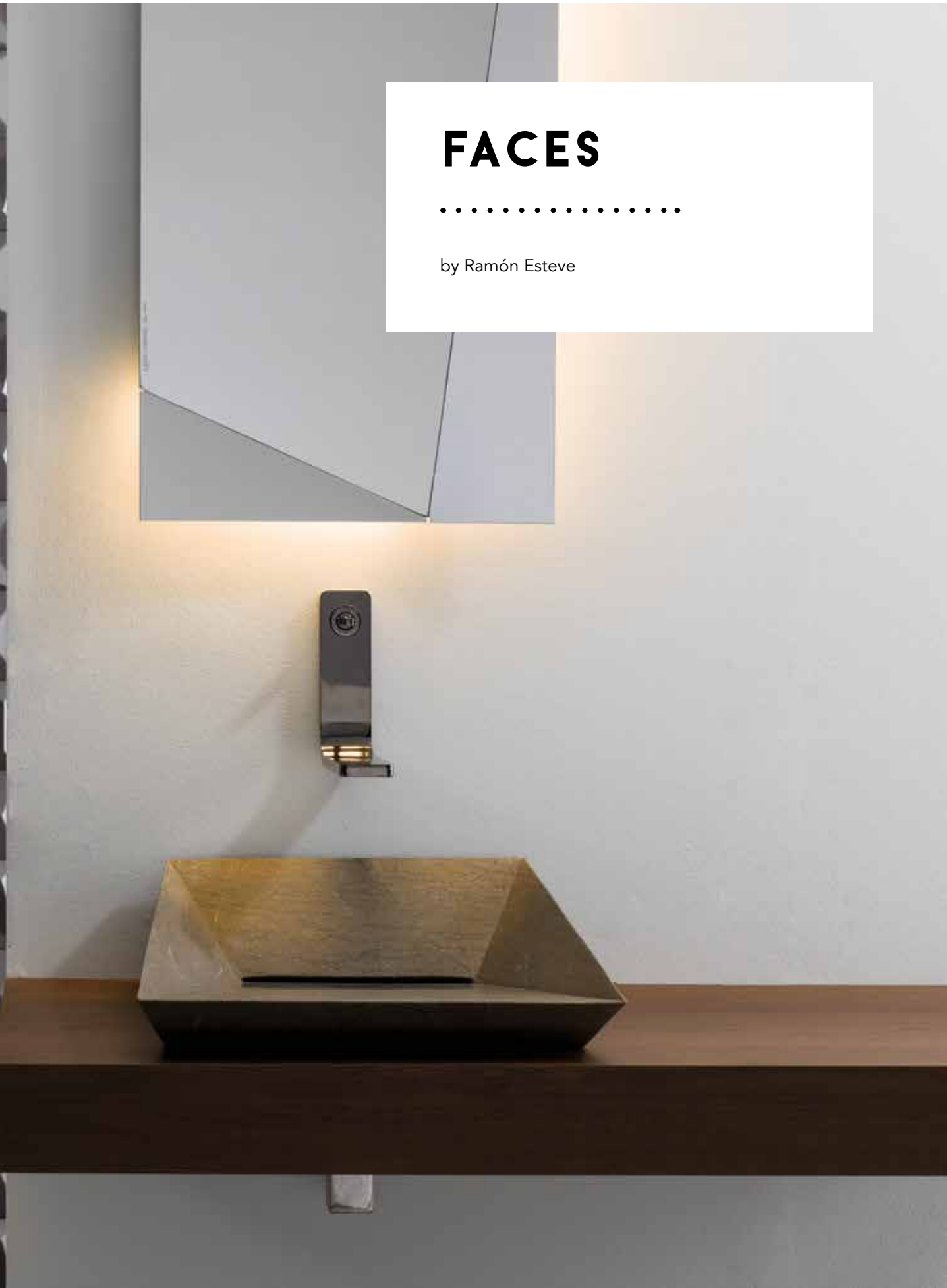

FACES

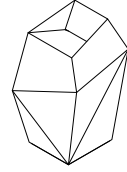
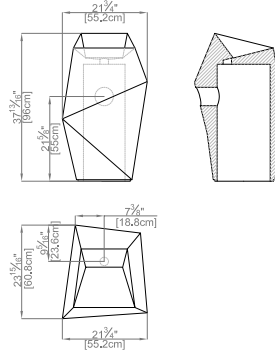

The set includes / El conjunto incluye / L'ensemble comprend les éléments suivants:
 -Wash basin / Lavabo / Lavabo.
 -Coupling / Junta de conexión / Joint de raccordement.
 -Maintenance kit / Kit de mantenimiento / Kit d'entretien.

Faces Stand



Description	Format	Codes	Group	Pcs	m2	Kg
Persian White Classico	55,2x50,7x96 cm	I00177109	G-196	1 x Cj	-	368 x Cj
	22 3/4"x20"x37 13/16"	L179702892		1 x Pal	-	308 Neto
Crema Italia Classico	55,2x50,7x96 cm	I00156522	G-196	1 x Cj	-	368 x Cj
	22 3/4"x20"x37 13/16"	L179702589		1 x Pal	-	308 Neto
Grey Stone Classico	55,2x50,7x96 cm	I00156523	G-196	1 x Cj	-	368 x Cj
	22 3/4"x20"x37 13/16"	L179702590		1 x Pal	-	308 Neto
Habana Dark Classico	55,2x50,7x96 cm	I00156524	G-196	1 x Cj	-	368 x Cj
	22 3/4"x20"x37 13/16"	L179702591		1 x Pal	-	308 Neto

Qmax L/min=6 l/min (Pressure/Presión/Pression= 3 bar).

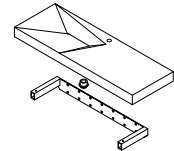
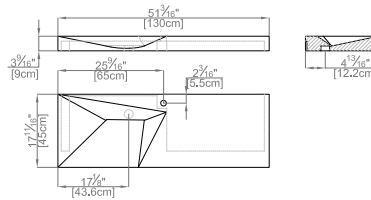

The set includes / El conjunto incluye / L'ensemble comprend les éléments suivants:
 -Wash basin / Lavabo / Lavabo.
 -Coupling / Junta de conexión / Joint de raccordement.
 -Bracket / Escuadra de sujeción / Équerre de fixation.
 -Screws / Tornillería / Visserie.
 -Maintenance kit / Kit de mantenimiento / Kit d'entretien.

Faces Mural



Description	Format	Codes	Group	Pcs	m2	Kg
Persian White Classico	130x45x9 cm	I00177118	G-188	1 x Cj	-	149 x Cj
	51 3/16"x17 11/16"x3 9/16"	L179702920		6 x Pal	-	96 Neto
Crema Italia Classico	130x45x9 cm	I00161235	G-186	1 x Cj	-	149 x Cj
	51 3/16"x17 11/16"x3 9/16"	L179702675		6 x Pal	-	96 Neto
Grey Stone Classico	130x45x9 cm	I00161137	G-186	1 x Cj	-	149 x Cj
	51 3/16"x17 11/16"x3 9/16"	L179702676		6 x Pal	-	96 Neto
Habana Dark Classico	130x45x9 cm	I00161276	G-188	1 x Cj	-	149 x Cj
	51 3/16"x17 11/16"x3 9/16"	L179702698		6 x Pal	-	96 Neto

Qmax L/min=6 l/min (Pressure/Presión/Pression= 3 bar).

FACES

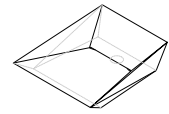
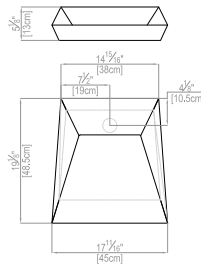

The set includes / El conjunto incluye / L'ensemble comprend les éléments suivants:
 -Wash basin / Lavabo / Lavabo.
 -Coupling / Junta de conexión / Joint de raccordement.

Bathrooms

Faces



Description	Format	Codes	Group	Pcs	m2	Kg
Persian White Classico	45x48,5x13 cm 17 11/16"x19 1/8"x5 1/8"	100177119 L179702914	G-182	1 x Cj 6 x Pal	- -	31 x Cj 27 Neto
Crema Italia Classico	45x48,5x13 cm 17 11/16"x19 1/8"x5 1/8"	100156488 L170302874	G-182	1 x Cj 6 x Pal	- -	31 x Cj 27 Neto
Grey Stone Classico	45x48,5x13 cm 17 11/16"x19 1/8"x5 1/8"	100156489 L170302873	G-182	1 x Cj 6 x Pal	- -	31 x Cj 27 Neto
Habana Dark Classico	45x48,5x13 cm 17 11/16"x19 1/8"x5 1/8"	100156520 L170302876	G-182	1 x Cj 6 x Pal	- -	31 x Cj 27 Neto

Qmax L/min=6 l/min (Pressure/Presión/Pression= 3 bar).

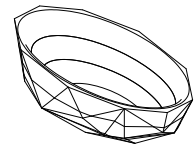
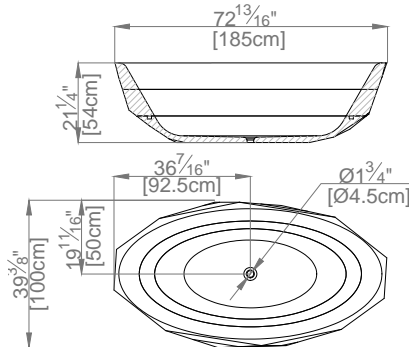

The set includes / El conjunto incluye / L'ensemble comprend les éléments suivants:
 -Bathtub / Bañera / Baignoire.
 -Installation kit / Kit de instalación / Kit d'installation.
 -Gasket / Junta de montaje / Joint de montage.
 -Maintenance kit / Kit de mantenimiento / Kit d'entretien.

Faces Bañera



Description	Format	Codes	Group	Pcs	m2	Kg
Persian White Classico	185x100x54 cm 72 13/16"x39 3/8"x21 1/4"	100179168 L179703014	G-199	1 x Cj 1 x Pal	- -	- -
Crema Italia Classico	185x100x54 cm 72 13/16"x39 3/8"x21 1/4"	100179166 L179703013	G-199	1 x Cj 1 x Pal	- -	- -
Grey Stone Classico	185x100x54 cm 72 13/16"x39 3/8"x21 1/4"	100179167 L179703012	G-199	1 x Cj 1 x Pal	- -	- -
Habana Dark Classico	185x100x54 cm 72 13/16"x39 3/8"x21 1/4"	100179190 L179703011	G-199	1 x Cj 1 x Pal	- -	- -



Vaciador Pulsador Clikler Sin Rebosadero
 100110743 - N698350001
 NOKEN



Stone waste cover / Embellecedor Piedra / Élément Décoratif Pierre

Hidden-drain pedestals are available on order in the same material and with the same finish as that used for the bathtubs. / Los embellecedores del desagüe pueden realizarse bajo pedido con el mismo material y acabado que la bañera. / Sur demande, les éléments décoratifs du drain peuvent être fabriqués dans le même matériel et avec les mêmes nitions que le baignoires.
 (See page / Ver página / Voir page 149).

FACES

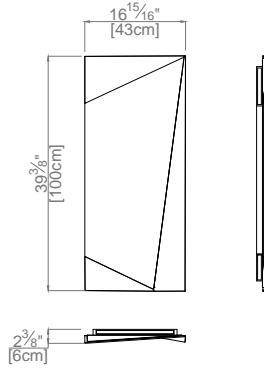

The set includes / El conjunto incluye /
L'ensemble comprend les éléments suivants:
-Mirrors / Espejo / Miroir.
-Screws / Tornillería / Visserie.

Faces Espejo Vertical



GLOSS

Description	Format	Codes	Group	Pcs	m2	Kg
Faces Espejo Vertical	43x100 cm 16 7/8" x 39 3/8"	100161527 LI79702721	G-176	1 x Cj 1 x Pal	- -	- -



Illuminated mirror fitted with LEDs on the perimeter.
/ Iluminado perimetralmente en los pliegues con
LEDs / Périmètre éclairé au niveau des plis avec
des LEDs.

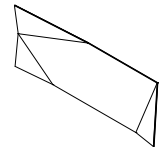
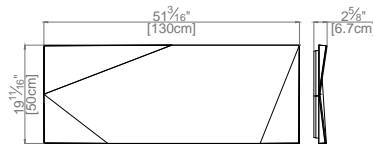

The set includes / El conjunto incluye /
L'ensemble comprend les éléments suivants:
-Mirrors / Espejo / Miroir.
-Screws / Tornillería / Visserie.

Faces Espejo Horizontal



GLOSS

Description	Format	Codes	Group	Pcs	m2	Kg
Faces Espejo Horizontal	130x50 cm 51 1/8" x 19 5/8"	100161508 LI79702719	G-178	1 x Cj 1 x Pal	- -	- -



Illuminated mirror fitted with LEDs on the perimeter.
/ Iluminado perimetralmente en los pliegues con
LEDs / Périmètre éclairé au niveau des plis avec
des LEDs.

FACES



Complementary products Faces Mural Habana Dark, Faces Espejo Horizontal



Complementary products Minimim Lavabo Stand Persian White, Minim Espejo 80x80 cm

MINIM

.....

by Ramón Esteve

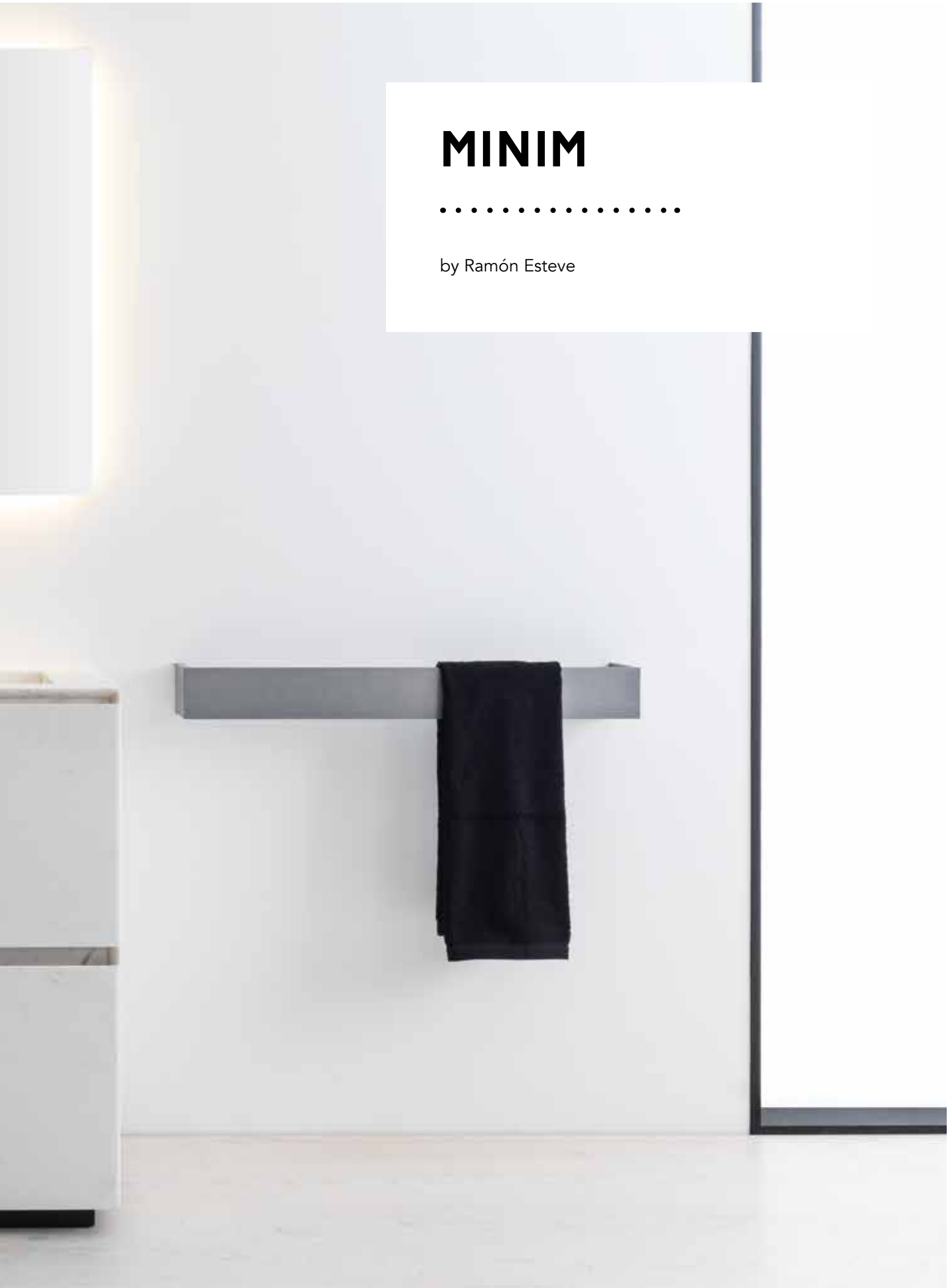

MINIM

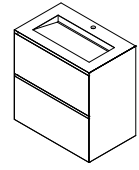
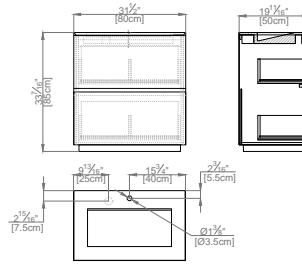

The set includes / El conjunto incluye / L'ensemble comprend les éléments suivants:

- Wash basin / Lavabo / Lavabo.
- Coupling / Junta de conexión / Joint de raccordement.
- Container box / Caja contenedora / Caisson.
- Screws / Tornillería / Visserie.
- Maintenance kit / Kit de mantenimiento / Kit d'entretien.

Minim Lavabo Stand



Description	Format	Codes	Group	Pcs	m2	Kg
Persian White Classico	80x85x50 cm	I00177150	G-193	1 x Cj	-	179 x Cj
	31 1/2"x33 7/16"x19 11/16"	L179702928		1 x Pal	-	119 Neto
Crema Italia Classico	80x85x50 cm	I00161324	G-193	1 x Cj	-	179 x Cj
	31 1/2"x33 7/16"x19 11/16"	L179702708		1 x Pal	-	119 Neto
Grey Stone Classico	80x85x50 cm	I00161288	G-193	1 x Cj	-	179 x Cj
	31 1/2"x33 7/16"x19 11/16"	L179702699		1 x Pal	-	119 Neto
Habana Dark Classico	80x85x50 cm	I00161333	G-193	1 x Cj	-	179 x Cj
	31 1/2"x33 7/16"x19 11/16"	L179702697		1 x Pal	-	119 Neto

Qmax L/min=7.5 l/min (Pressure/Presión/Pression= 3 bar).

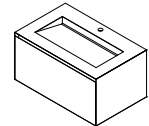
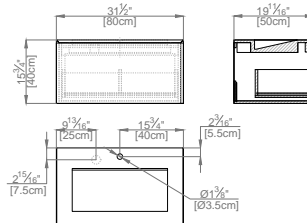

The set includes / El conjunto incluye / L'ensemble comprend les éléments suivants:

- Wash basin / Lavabo / Lavabo.
- Coupling / Junta de conexión / Joint de raccordement.
- Container box / Caja contenedora / Caisson.
- Screws / Tornillería / Visserie.
- Maintenance kit / Kit de mantenimiento / Kit d'entretien.

Minim Lavabo



Description	Format	Codes	Group	Pcs	m2	Kg
Persian White Classico	80x40x50 cm	I00177139	G-189	1 x Cj	-	135 x Cj
	31 1/2"x15 3/4"x19 11/16"	L179702896		1 x Pal	-	82 Neto
Crema Italia Classico	80x40x50 cm	I00161322	G-189	1 x Cj	-	135 x Cj
	31 1/2"x15 3/4"x19 11/16"	L179702687		1 x Pal	-	82 Neto
Grey Stone Classico	80x40x50 cm	I00161323	G-189	1 x Cj	-	135 x Cj
	31 1/2"x15 3/4"x19 11/16"	L179702712		1 x Pal	-	82 Neto
Habana Dark Classico	80x40x50 cm	I00161318	G-189	1 x Cj	-	135 x Cj
	31 1/2"x15 3/4"x19 11/16"	L179702695		1 x Pal	-	82 Neto

Qmax L/min=7.5 l/min (Pressure/Presión/Pression= 3 bar).

MINIM

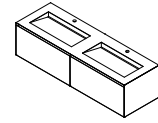
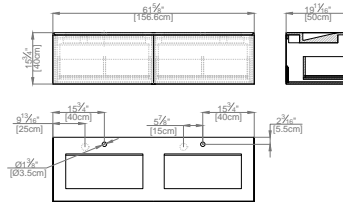

The set includes / El conjunto incluye / L'ensemble comprend les éléments suivants:

- Wash basin / Lavabo / Lavabo.
- Coupling / Junta de conexión / Joint de raccordement.
- Container box / Caja contenedora / Caisson.
- Screws / Tornillería / Visserie.
- Maintenance kit / Kit de mantenimiento / Kit d'entretien.

Minim Lavabo Doble



Description	Format	Codes	Group	Pcs	m2	Kg
Persian White Classico	156.6x40x50 cm 61 5/8"x15 3/4"x19 5/8"	100177141 L179702895	G-195	1 x Cj 1 x Pal	-	240 x Cj 180 Neto
Crema Italia Classico	156.6x40x50 cm 61 5/8"x15 3/4"x19 5/8"	100161316 L179702689	G-195	1 x Cj 1 x Pal	-	240 x Cj 180 Neto
Grey Stone Classico	156.6x40x50 cm 61 5/8"x15 3/4"x19 5/8"	100161317 L179702681	G-195	1 x Cj 1 x Pal	-	240 x Cj 180 Neto
Habana Dark Classico	156.6x40x50 cm 61 5/8"x15 3/4"x19 5/8"	100161287 L179702691	G-195	1 x Cj 1 x Pal	-	240 x Cj 180 Neto

Qmax L/min=7.5 l/min (Pressure/Presión/Pression= 3 bar).

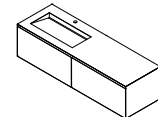
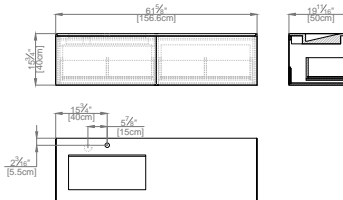

The set includes / El conjunto incluye / L'ensemble comprend les éléments suivants:

- Wash basin / Lavabo / Lavabo.
- Coupling / Junta de conexión / Joint de raccordement.
- Container box / Caja contenedora / Caisson.
- Screws / Tornillería / Visserie.
- Maintenance kit / Kit de mantenimiento / Kit d'entretien.

Minim Lavabo + Encimera



Description	Format	Codes	Group	Pcs	m2	Kg
Persian White Classico	156.6x40x50 cm 61 5/8"x15 3/4"x19 5/8"	100177142 L179702897	G-194	1 x Cj 1 x Pal	-	218 x Cj 158 Neto
Crema Italia Classico	156.6x40x50 cm 61 5/8"x15 3/4"x19 5/8"	100161289 L179702692	G-194	1 x Cj 1 x Pal	-	218 x Cj 158 Neto
Grey Stone Classico	156.6x40x50 cm 61 5/8"x15 3/4"x19 5/8"	100161340 L179702671	G-194	1 x Cj 1 x Pal	-	218 x Cj 158 Neto
Habana Dark Classico	156.6x40x50 cm 61 5/8"x15 3/4"x19 5/8"	100161334 L179702705	G-194	1 x Cj 1 x Pal	-	218 x Cj 158 Neto

Qmax L/min=7.5 l/min (Pressure/Presión/Pression= 3 bar).

MINIM

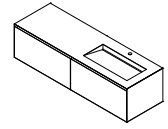
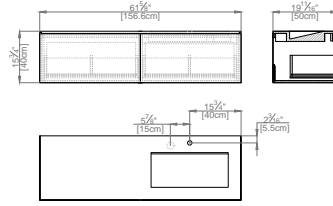

The set includes / El conjunto incluye / L'ensemble comprend les éléments suivants:
 -Wash basin / Lavabo / Lavabo.
 -Coupling / Junta de conexión / Joint de raccordement.
 -Container box / Caja contenedora / Caisson.
 -Screws / Tornillería / Visserie.
 -Maintenance kit / Kit de mantenimiento / Kit d'entretien.

Minim Encimera + Lavabo



Description	Format	Codes	Group	Pcs	M2	Kg
Persian White Classico	156,6x40x50 cm	I00177138	G-194	1 x Cj	-	218 x Cj
	61 5/8"x15 3/4"x19 5/8"	L179702894		1 x Pal	-	158 Neto
Crema Italia Classico	156,6x40x50 cm	I00161320	G-194	1 x Cj	-	218 x Cj
	61 5/8"x15 3/4"x19 5/8"	L179702680		1 x Pal	-	158 Neto
Grey Stone Classico	156,6x40x50 cm	I00161330	G-194	1 x Cj	-	218 x Cj
	61 5/8"x15 3/4"x19 5/8"	L179702710		1 x Pal	-	158 Neto
Habana Dark Classico	156,6x40x50 cm	I00161321	G-194	1 x Cj	-	218 x Cj
	61 5/8"x15 3/4"x19 5/8"	L179702702		1 x Pal	-	158 Neto

Qmax L/min=7.5 l/min (Pressure/Presión/Pression= 3 bar).



Wall Coverings Habana Grey Classico / Complementary products Minim Encimera + Lavabo Grey Stone

MINIM

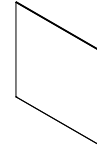
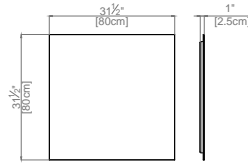

The set includes / El conjunto incluye /
L'ensemble comprend les éléments suivants:
-Mirrors / Espejo / Miroir.
-Screws / Tornillería / Visserie.



Mirror with LED lit perimeter / Iluminado
perimetralmente con LEDs. / Illuminé sur le
périmètre avec des LEDs. LEDs 2800°K. 9.8 V.

Minim Espejo 80x80 cm



GLOSS

Description	Format	Codes	Group	Pcs	M2	Kg
Minim Espejo	80x80 cm 31 1/2"x31 1/2"	100161542 L179702720	G-175	1 x Cj 10 x Pal	- -	- -

Steam free mirror with built-in demister / Espejo
con Sistema Antivaho incorporado que evita que se
empañe. / Miroir avec système anti-buée intégré qui
empêche que s'embue.

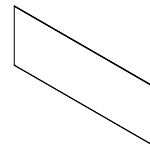
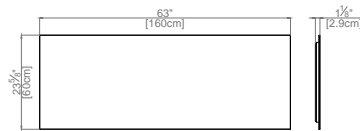

The set includes / El conjunto incluye /
L'ensemble comprend les éléments suivants:
-Mirrors / Espejo / Miroir.
-Screws / Tornillería / Visserie.



Mirror with LED lit perimeter / Iluminado
perimetralmente con LEDs. / Illuminé sur le
périmètre avec des LEDs. LEDs 2800°K. 9.8 V.

Minim Espejo 160x60 cm



GLOSS

Description	Format	Codes	Group	Pcs	M2	Kg
Minim Espejo	160x60 cm 63"x23 5/8"	100161560 L179702722	G-178	1 x Cj 1 x Pal	- -	- -

Steam free mirror with built-in demister / Espejo
con Sistema Antivaho incorporado que evita que se
empañe. / Miroir avec système anti-buée intégré qui
empêche que s'embue.

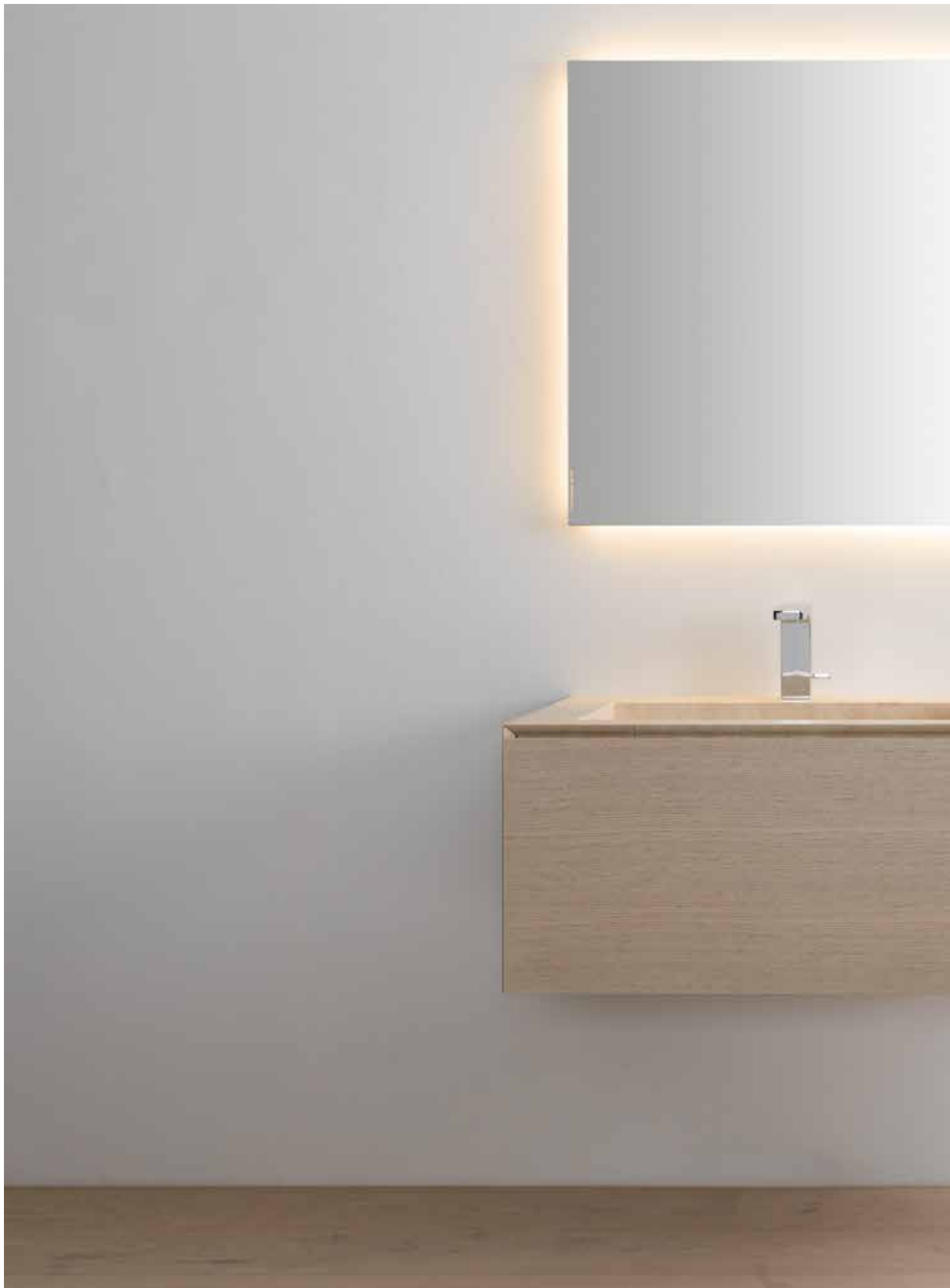

Complementary products Minimim Wood Roble Beige - Crema Italia, Minim Espejo 80x80 cm

MINIM WOOD

.....

by Ramón Esteve

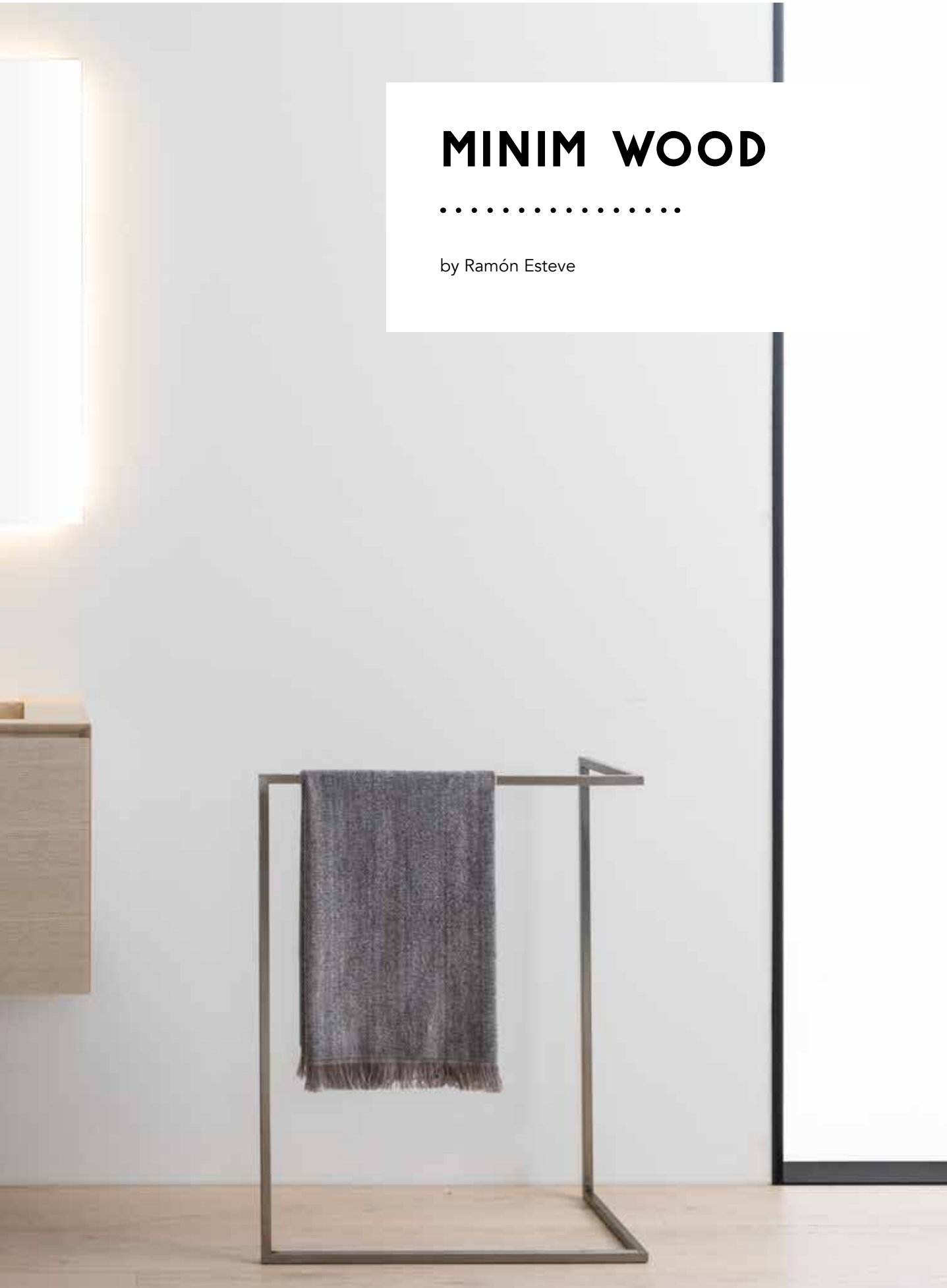

MINIM WOOD

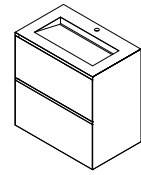
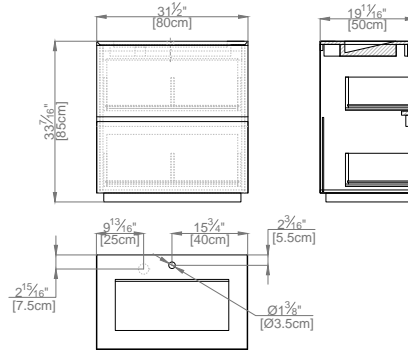

The set includes / El conjunto incluye / L'ensemble comprend les éléments suivants:
 -Wash basin / Lavabo / Lavabo.
 -Coupling / Junta de conexión / Joint de raccordement.
 -Container box / Caja contenedora / Caisson.
 -Screws / Tornillería / Visserie.
 -Maintenance kit / Kit de mantenimiento / Kit d'entretien.

Minim Wood Stand



Description	Format	Codes	Group	Pcs	m2	Kg
Roble Snow / Persian White Classico	80x52x85 cm 31 1/2"x19 11/16"x33 7/16"	100179676 L179702997	G-193	1 x Cj 1 x Pal	-	165.6 x Cj 165.6 x Pal
Roble Beige / Crema Italia Classico	80x52x85 cm 31 1/2"x19 11/16"x33 7/16"	100179675 L179702994	G-193	1 x Cj 1 x Pal	-	165.6 x Cj 165.6 x Pal
Roble Grey / Grey Stone Classico	80x52x85 cm 31 1/2"x19 11/16"x33 7/16"	100179656 L179702993	G-193	1 x Cj 1 x Pal	-	165.6 x Cj 165.6 x Pal
Roble Earth / Habana Dark Classico	80x52x85 cm 31 1/2"x19 11/16"x33 7/16"	100179657 L179702996	G-193	1 x Cj 1 x Pal	-	165.6 x Cj 165.6 x Pal

Qmax L/min=7.5 l/min (Pressure/Presión/Pression= 3 bar).

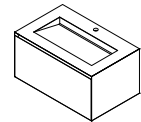
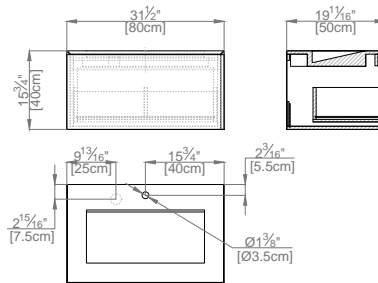

The set includes / El conjunto incluye / L'ensemble comprend les éléments suivants:
 -Wash basin / Lavabo / Lavabo.
 -Coupling / Junta de conexión / Joint de raccordement.
 -Container box / Caja contenedora / Caisson.
 -Screws / Tornillería / Visserie.
 -Maintenance kit / Kit de mantenimiento / Kit d'entretien.

Minim Wood



Description	Format	Codes	Group	Pcs	m2	Kg
Roble Snow / Persian White Classico	80x50x40 cm 31 1/2"x19 11/16"x15 3/4"	100179674 L179703017	G-189	1 x Cj 1 x Pal	-	77.93 x Cj 77.93 x Pal
Roble Beige / Crema Italia Classico	80x50x40 cm 31 1/2"x19 11/16"x15 3/4"	100179612 L179703015	G-189	1 x Cj 1 x Pal	-	77.93 x Cj 77.93 x Pal
Roble Grey / Grey Stone Classico	80x50x40 cm 31 1/2"x19 11/16"x15 3/4"	100179596 L179703018	G-189	1 x Cj 1 x Pal	-	77.93 x Cj 77.93 x Pal
Roble Earth / Habana Dark Classico	80x50x40 cm 31 1/2"x19 11/16"x15 3/4"	100179584 L179703016	G-189	1 x Cj 1 x Pal	-	77.93 x Cj 77.93 x Pal

Qmax L/min=7.5 l/min (Pressure/Presión/Pression= 3 bar).

MINIM WOOD

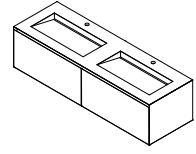
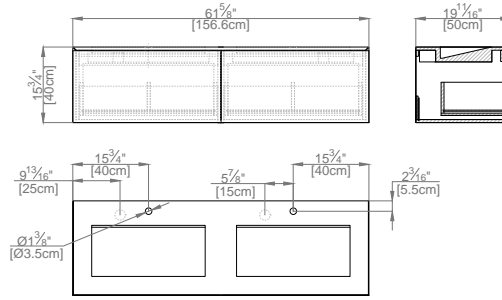

The set includes / El conjunto incluye / L'ensemble comprend les éléments suivants:

- Wash basin / Lavabo / Lavabo.
- Coupling / Junta de conexión / Joint de raccordement.
- Container box / Caja contenedora / Caisson.
- Screws / Tornillería / Visserie.
- Maintenance kit / Kit de mantenimiento / Kit d'entretien.

Bathrooms

Minim Wood Doble



Description	Format	Codes	Group	Pcs	m2	Kg
Roble Snow / Persian White Classico	156.6x50x40 cm	100179613	G-195	1 x Cj	-	228 x Cj
	61 5/8"x19 11/16"x15 3/4"	L179702986		1 x Pal	-	228 x Pal
Roble Beige / Crema Italia	156.6x50x40 cm	100179602	G-195	1 x Cj	-	228 x Cj
	61 5/8"x19 11/16"x15 3/4"	L179702991		1 x Pal	-	228 x Pal
Roble Grey / Grey Stone	156.6x50x40 cm	100179595	G-195	1 x Cj	-	228 x Cj
	61 5/8"x19 11/16"x15 3/4"	L179702988		1 x Pal	-	228 x Pal
Roble Earth / Habana Dark	156.6x50x40 cm	100179603	G-195	1 x Cj	-	228 x Cj
	61 5/8"x19 11/16"x15 3/4"	L179702990		1 x Pal	-	228 x Pal

Qmax L/min=7.5 l/min (Pressure/Presión/Pression= 3 bar).

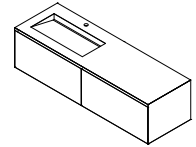
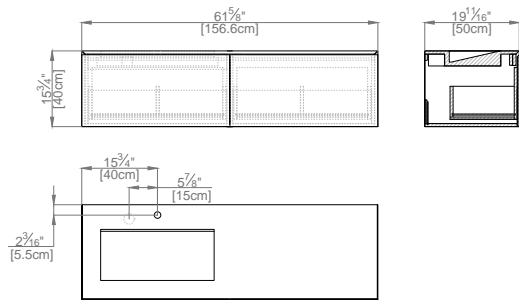

The set includes / El conjunto incluye / L'ensemble comprend les éléments suivants:

- Wash basin / Lavabo / Lavabo.
- Coupling / Junta de conexión / Joint de raccordement.
- Container box / Caja contenedora / Caisson.
- Screws / Tornillería / Visserie.
- Maintenance kit / Kit de mantenimiento / Kit d'entretien.

Minim Wood Lavabo + Encimera



Description	Format	Codes	Group	Pcs	m2	Kg
Roble Snow / Persian White Classico	156.6x50x40 cm	100179632	G-194	1 x Cj	-	228 x Cj
	61 5/8"x19 11/16"x15 3/4"	L179702995		1 x Pal	-	228 x Pal
Roble Beige / Crema Italia Classico	156.6x50x40 cm	100179618	G-194	1 x Cj	-	228 x Cj
	61 5/8"x19 11/16"x15 3/4"	L179702989		1 x Pal	-	228 x Pal
Roble Grey / Grey Stone Classico	156.6x50x40 cm	100179631	G-194	1 x Cj	-	228 x Cj
	61 5/8"x19 11/16"x15 3/4"	L179702992		1 x Pal	-	228 x Pal
Roble Earth / Habana Dark Classico	156.6x50x40 cm	100179585	G-194	1 x Cj	-	228 x Cj
	61 5/8"x19 11/16"x15 3/4"	L179702984		1 x Pal	-	228 x Pal

Qmax L/min=7.5 l/min (Pressure/Presión/Pression= 3 bar).

MINIM WOOD

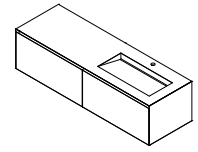
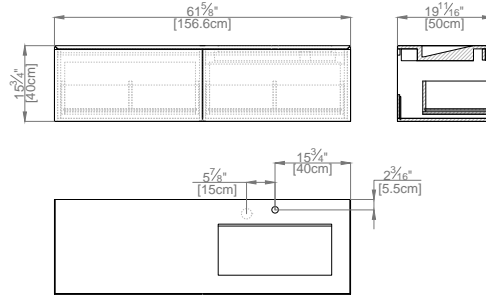

The set includes / El conjunto incluye / L'ensemble comprend les éléments suivants:

- Wash basin / Lavabo / Lavabo.
- Coupling / Junta de conexión / Joint de raccordement.
- Container box / Caja contenedora / Caisson.
- Screws / Tornillería / Visserie.
- Maintenance kit / Kit de mantenimiento / Kit d'entretien.

Minim Wood Encimera + Lavabo



Description	Format	Codes	Group	Pcs	m2	Kg
Roble Snow / Persian White Classico	156.6x50x40 cm 61 5/8"x19 1/8"x15 3/4"	100179617 L179702983	G-194	1 x Cj 1 x Pal	-	228 x Cj 228 x Pal
Roble Beige / Crema Italia Classico	156.6x50x40 cm 61 5/8"x19 1/8"x15 3/4"	100179614 L179702982	G-194	1 x Cj 1 x Pal	-	228 x Cj 228 x Pal
Roble Grey / Grey Stone Classico	156.6x50x40 cm 61 5/8"x19 1/8"x15 3/4"	100179616 L179702987	G-194	1 x Cj 1 x Pal	-	228 x Cj 228 x Pal
Roble Earth / Habana Dark Classico	156.6x50x40 cm 61 5/8"x19 1/8"x15 3/4"	100179615 L179702985	G-194	1 x Cj 1 x Pal	-	228 x Cj 228 x Pal

Qmax L/min=7.5 l/min (Pressure/Presión/Pression= 3 bar).



Complementary products Minim Wood Roble Earth - Habana Dark

MINIM WOOD



Complementary products Minim Wood Roble Beige - Crema Italia, Minim Espejo 80x80 cm



Complementary products Azrama Primitive Vanity

AZRAMA

.....

by Clodagh

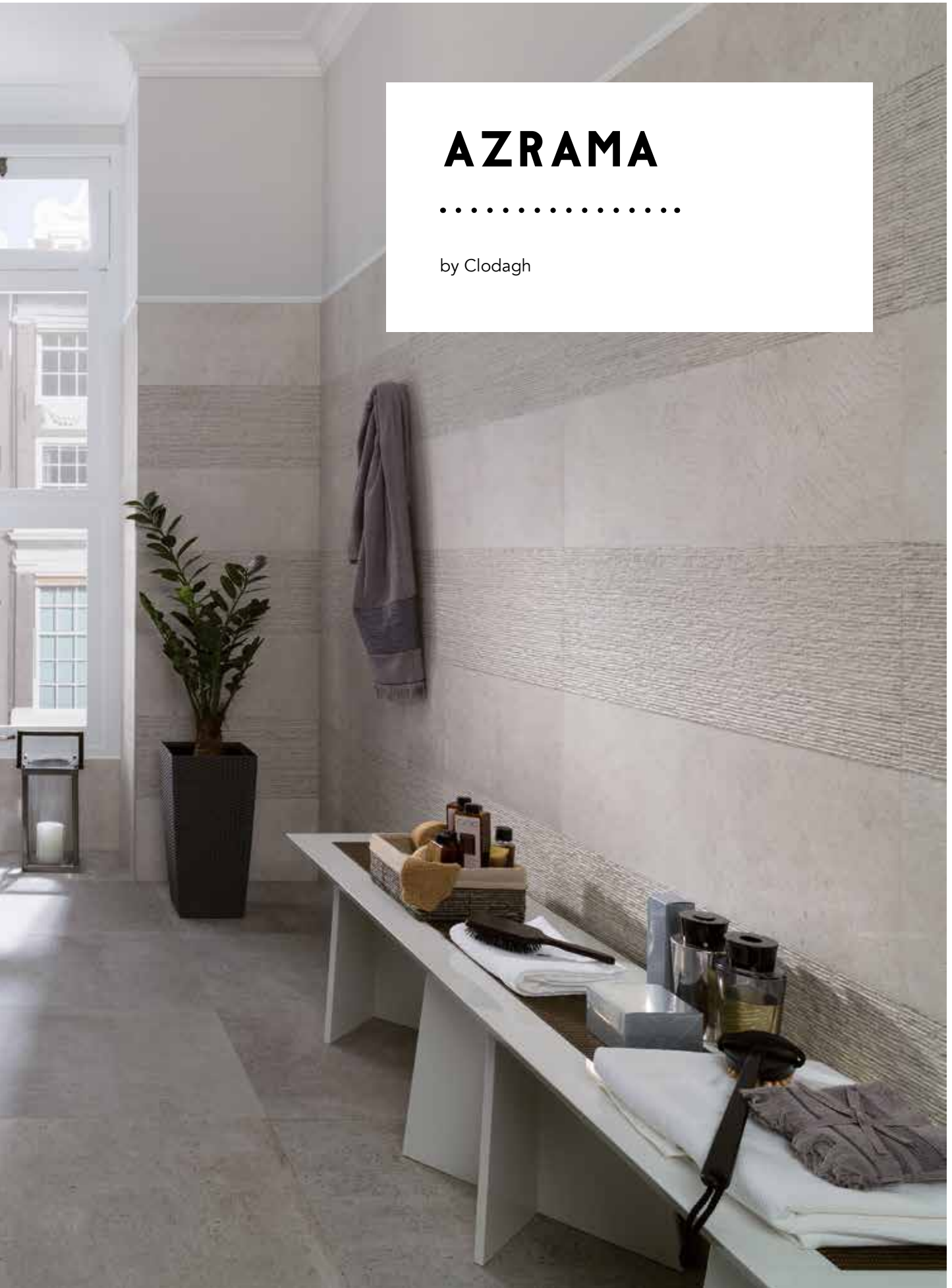

AZRAMA

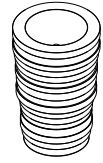
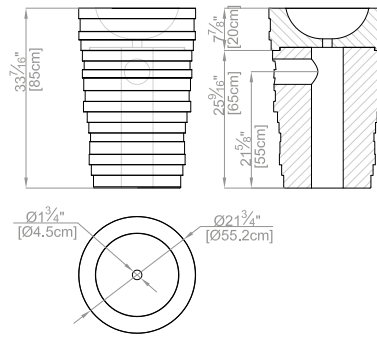

The set includes / El conjunto incluye / L'ensemble comprend les éléments suivants:
 -Wash basin / Lavabo / Lavabo.
 -Maintenance kit / Kit de mantenimiento / Kit d'entretien.

Azrama Primitive Vanity



Casquillo Desagüe 2Cm Cromo
 100043169 - N899393001
 NOKEN



Vaciador Fijo Sin Rebosadero Cromo
 100040383 - N299606001
 NOKEN

Description	Format	Codes	Group	Pcs	m2	Kg
Habana Brown Classico	55,2x55,2x85 cm 21 3/4"x21 3/4"x33 7/16"	100142876 LI79702352	G-193	1 x Cj 1 x Pal	-	437 x Cj 377 Neto

Qmax L/min=12 l/min (Pressure/Presión/Pression= 3 bar).



Stone waste cover / Embellecedor Piedra / Élément Décoratif Pierre

Hidden-drain pedestals are available on order in the same material and with the same finish as that used for the wash basin. / Los embellecedores del desagüe pueden realizarse bajo pedido con el mismo material y acabado que el lavabo. / Sur demande, les éléments décoratifs du drain peuvent être fabriqués dans le même matériel et avec les mêmes finitions que le lavabo.
 (See page / Ver página / Voir page 139).

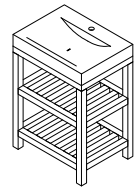
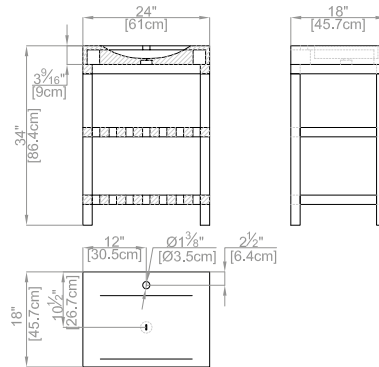

The set includes / El conjunto incluye / L'ensemble comprend les éléments suivants:
 -Wash basin / Lavabo / Lavabo.
 -Coupling / Junta de conexión / Joint de raccordement.
 -Furniture / Mueble / Meuble.



Superficie exterior texturada

Azrama Vanity Single



Recommended taps / Griferías recomendadas / Robinetteries recommandées

- Hotels 100126422 - N194710553
- Urban 100121305 - N199999610 (con aireador)
- Libra* 100038646 - N160010001 (con aireador)
NOKEN

Description	Format	Codes	Group	Pcs	m2	Kg
Habana Brown / Iroko	61x84,6x45,7 cm 24"x34"x18"	100146487 LI79702442	G-188	1 x Cj 1 x Pal	-	90 x Cj 53 Neto

Qmax L/min=12 l/min (Pressure/Presión/Pression= 3 bar).

*Only EEUU / Sólo EEUU / Seulement EEUU

AZRAMA



Superficie exterior texturada

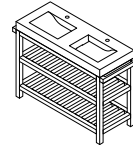
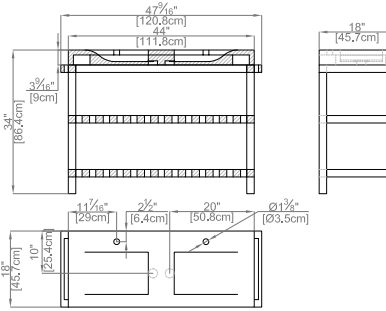

The set includes / El conjunto incluye / L'ensemble comprend les éléments suivants:
 -Wash basin / Lavabo / Lavabo.
 -Coupling / Junta de conexión / Joint de raccordement.
 -Forniture / Mueble / Meuble.

Azrama Vanity Double



MATT



FREE-STANDING WASHBASIN



BIOPROT

Description	Format	Codes	Group	Pcs	m2	Kg
Habana Brown / Iroko	120,8x86,4x45,7 cm 44"x34"x18"	100146486 L179702417	G-195	1 x Cj 1 x Pal	- -	140 x Cj 99 Neto

Qmax L/min=12 l/min (Pressure/Presión/Pression= 3 bar).



Superficie exterior texturada

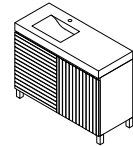
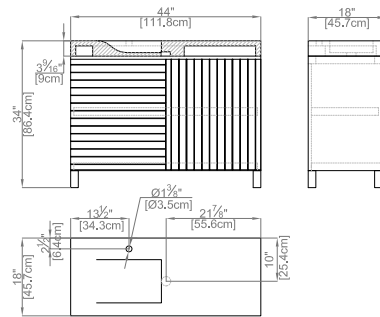

The set includes / El conjunto incluye / L'ensemble comprend les éléments suivants:
 -Wash basin / Lavabo / Lavabo.
 -Coupling / Junta de conexión / Joint de raccordement.
 -Forniture / Mueble / Meuble.

Azrama Vanity Doors



MATT



FREE-STANDING WASHBASIN



BIOPROT

Description	Format	Codes	Group	Pcs	m2	Kg
Habana Brown / Iroko	111,8x86,4x45,7 cm 44"x34"x18"	100146485 L179702458	G-195	1 x Cj 1 x Pal	- -	151 x Cj 110 Neto

Qmax L/min=12 l/min (Pressure/Presión/Pression= 3 bar).



Complementary products Spirit Lavabo A-cero Gloss, Spirit Mueble Roble Intenso, Spirit Espejo Neboa

SPIRIT

.....

by A-cero

SPIRIT

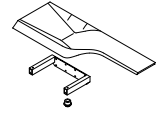
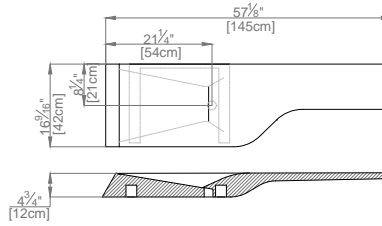

The set includes / El conjunto incluye / L'ensemble comprend les éléments suivants:
 -Wash basin / Lavabo / Lavabo.
 -Coupling / Junta de conexión / Joint de raccordement.
 -Bracket / Escuadra de sujeción / Équerre de fixation.
 -Screws / Tornillería / Visserie.
 -Maintenance kit / Kit de mantenimiento / Kit d'entretien.

Spirit Lavabo



Description	Format	Codes	Group	Pcs	m2	Kg
A-cero Dark	145x42x12 cm 57 1/8"x16 9/16"x4 3/4"	100098337 L171301224	G-189	1 x Cj 1 x Pal	-	125 x Cj 89 Neto
A-cero Gloss	145x42x12 cm 57 1/8"x16 9/16"x4 3/4"	100098331 L171301223	G-189	1 x Cj 1 x Pal	-	125 x Cj 89 Neto

Qmax L/min=10 l/min (Pressure/Presión/Pression= 3 bar).

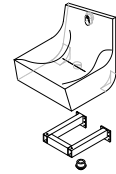
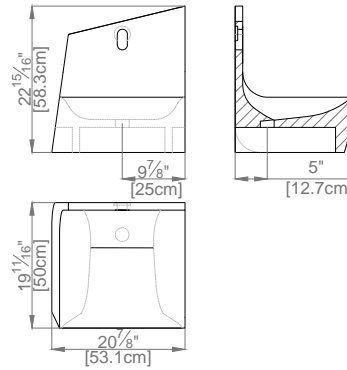

The set includes / El conjunto incluye / L'ensemble comprend les éléments suivants:
 -Wash basin / Lavabo / Lavabo.
 -Coupling / Junta de conexión / Joint de raccordement.
 -Bracket / Escuadra de sujeción / Équerre de fixation.
 -Screws / Tornillería / Visserie.
 -Maintenance kit / Kit de mantenimiento / Kit d'entretien.

Spirit II Lavabo



Description	Format	Codes	Group	Pcs	m2	Kg
A-cero Dark	53,1x50 cm 20 7/8"x19 11/16"	100112177 L170302655	G-192	1 x Cj 1 x Pal	-	130 x Cj 95 Neto
A-cero Gloss	53,1x50 cm 20 7/8"x19 11/16"	100112178 L170302656	G-192	1 x Cj 1 x Pal	-	130 x Cj 95 Neto

Qmax L/min=6.5 l/min (Pressure/Presión/Pression= 3 bar).



Grifería Lounge
 100063522 - N199999990
Aireador
 100098000 - N299999432
 NOKEN



Sifón Acro
 100101721 - N172390018
 NOKEN

SPIRIT

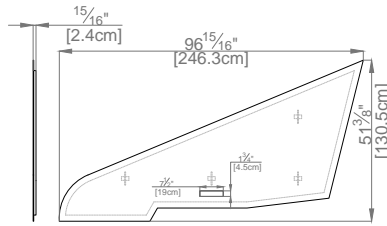

The set includes / El conjunto incluye /
L'ensemble comprend les éléments suivants:
-Mirrors / Espejo / Miroir:
-Screws / Tornillería / Visserie.

Spirit Espejo Neboa



GLOSS

Descripción	Formato	Códigos	Grupo	Pz	m2	Kg
Spirit Espejo Neboa	246,3x130,5 cm 96 15/16"x51 3/8"	100098330 L179702086	G-178	1 x Cj 5 x Pal	-	82,80 x Cj 31,80 Neto



EEUJ / NK Logic
100143677 - NI40140074
NOKEN



MONOMANDO LAVABO
ENCASTRE. IRTA.WBAS
IRTA MIXER TAP ENC.
100038708 - NI61011301
NOKEN

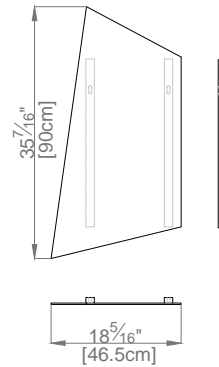

The set includes / El conjunto incluye /
L'ensemble comprend les éléments suivants:
-Mirrors / Espejo / Miroir:
-Screws / Tornillería / Visserie.

Spirit II Espejo



GLOSS

Descripción	Formato	Códigos	Grupo	Pz	m2	Kg
Spirit Espejo II	90x46,5 cm 35 7/16"x18 5/16"	100112176 L175000023	G-171	1 x Cj 5 x Pal	-	13,85 x Cj 6 Neto

SPIRIT

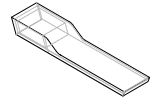
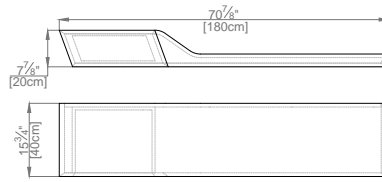

The set includes / El conjunto incluye /
L'ensemble comprend les éléments suivants:
-Furniture / Mueble / Meuble.
-Screws / Tornillería / Visserie.

Spirit Mueble



MATT

Description	Format	Codes	Group	Pcs	m2	Kg
Roble Ceniza	180x20x40 cm 70 7/8"x7 7/8"x15 3/4"	100098321 LI75000015	G-184	1 x Cj 8 x Pal	- -	13,85 x Cj 6 Neto
Roble Intenso	180x20x40 cm 70 7/8"x7 7/8"x15 3/4"	100098322 LI75000016	G-184	1 x Cj 8 x Pal	- -	13,85 x Cj 6 Neto



Complementary products Spirit Lavabo A-cero Dark, Spirit Mueble Roble Ceniza

SPIRIT



Complementary products Spirit II Lavabo A-cero Gloss, Spirit II Espejo



Floor Coverings Arctic White Classico / Wall Coverings Calpe Nieve, Javea Black / Complementary products Saint Germain Totem Crochet Blanc - Noir

SAINT GERMAIN

.....

by Lázaro Rosa-Violán

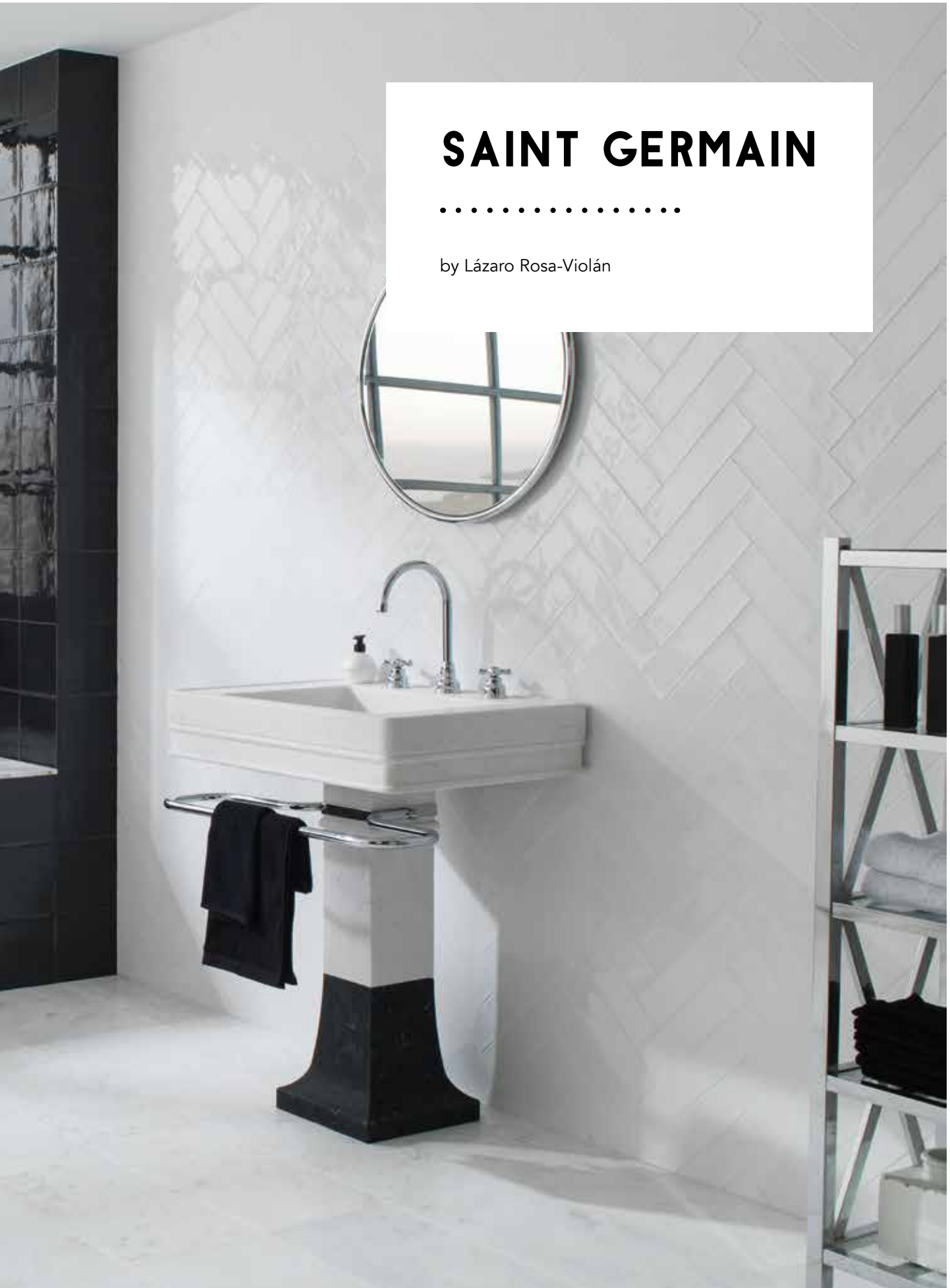

SAINT GERMAIN

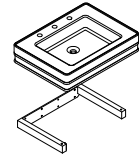
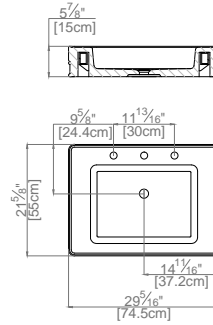

The set includes / El conjunto incluye / L'ensemble comprend les éléments suivants:
 -Wash basin / Lavabo / Lavabo.
 -Bracket / Escuadra de sujeción / Équerre de fixation.
 -Screws / Tornillería / Visserie.
 -Maintenance kit / Kit de mantenimiento / Kit d'entretien.

Saint Germain Lavabo



Description	Format	Codes	Group	Pcs	m2	Kg
Blanc	74.5x55x15 cm 29 5/16"x21 5/8"x5 7/8"	100179773 L179703034	G-181	1 x Cj 1 x Pal	- -	103.52 x Cj 103.52 x Pal
Noir	74.5x55x15 cm 29 5/16"x21 5/8"x5 7/8"	100179764 L179703024	G-181	1 x Cj 1 x Pal	- -	103.52 x Cj 103.52 x Pal

Qmax L/min=12 l/min (Pressure/Presión/Pression= 3 bar).



Casquillo Desagüe 2Cm Cromo
100043169 - N899393001
NOKEN



Vaciador Fijo Sin Rebosadero Cromo
100040383 - N299606001
NOKEN



Stone waste cover / Embellecedor Piedra / Élément Décoratif Pierre
 Hidden-drain pedestals are available on order in the same material and with the same finish as that used for the wash basin. / Los embellecedores del desagüe pueden realizarse bajo pedido con el mismo material y acabado que el lavabo. / Sur demande, les éléments décoratifs du drain peuvent être fabriqués dans le même matériel et avec les mêmes finitions que le lavabo.
 (See page / Ver página / Voir page 139).

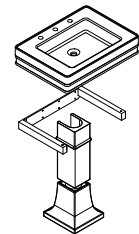
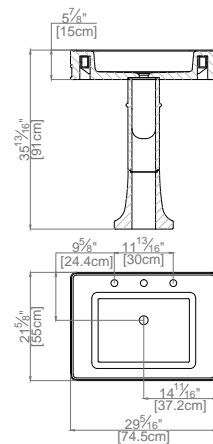

The set includes / El conjunto incluye / L'ensemble comprend les éléments suivants:
 -Wash basin / Lavabo / Lavabo.
 -Bracket / Escuadra de sujeción / Équerre de fixation.
 -Screws / Tornillería / Visserie.
 -Maintenance kit / Kit de mantenimiento / Kit d'entretien.

Saint Germain Totem



Description	Format	Codes	Group	Pcs	m2	Kg
Washbasin Blanc / Base Blanc	74.5x55x91 cm 29 5/16"x21 5/8"x35 13/16"	100179776 L179703003	G-193	1 x Cj 1 x Pal	- -	218.72 x Cj 218.72 x Pal
Washbasin Blanc / Base Noir	74.5x55x91 cm 29 5/16"x21 5/8"x35 13/16"	100179787 L179703026	G-193	1 x Cj 1 x Pal	- -	218.72 x Cj 218.72 x Pal
Washbasin Noir / Base Noir	74.5x55x91 cm 29 5/16"x21 5/8"x35 13/16"	100179790 L179703005	G-193	1 x Cj 1 x Pal	- -	218.72 x Cj 218.72 x Pal
Washbasin Noir / Base Blanc	74.5x55x91 cm 29 5/16"x21 5/8"x35 13/16"	100179779 L179703007	G-193	1 x Cj 1 x Pal	- -	218.72 x Cj 218.72 x Pal

Qmax L/min=12 l/min (Pressure/Presión/Pression= 3 bar).



Casquillo Desagüe 2Cm Cromo
100043169 - N899393001
NOKEN



Vaciador Fijo Sin Rebosadero Cromo
100040383 - N299606001
NOKEN



Stone waste cover / Embellecedor Piedra / Élément Décoratif Pierre
 Hidden-drain pedestals are available on order in the same material and with the same finish as that used for the wash basin. / Los embellecedores del desagüe pueden realizarse bajo pedido con el mismo material y acabado que el lavabo. / Sur demande, les éléments décoratifs du drain peuvent être fabriqués dans le même matériel et avec les mêmes finitions que le lavabo.
 (See page / Ver página / Voir page 139).

SAINT GERMAIN

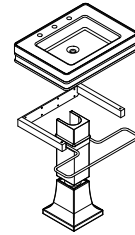
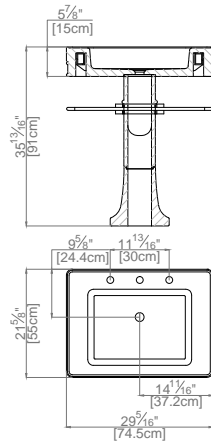

The set includes / El conjunto incluye / L'ensemble comprend les éléments suivants:
 -Wash basin / Lavabo / Lavabo.
 -Bracket / Escuadra de sujeción / Équerre de fixation.
 -Screws / Tornillería / Visserie.
 -Maintenance kit / Kit de mantenimiento / Kit d'entretien.

Saint Germain Totem Crochet



Description	Format	Codes	Group	Pcs	m2	Kg
Washbasin Blanc / Base Blanc	74.5x55x91 cm 29 5/16"x21 5/8"x35 13/16"	100179777 L179703027	G-194	1 x Cj 1 x Pal	-	218,72 x Cj 218,72 x Pal
Washbasin Blanc / Base Noir	74.5x55x91 cm 29 5/16"x21 5/8"x35 13/16"	100179788 L179703033	G-194	1 x Cj 1 x Pal	-	218,72 x Cj 218,72 x Pal
Washbasin Noir / Base Noir	74.5x55x91 cm 29 5/16"x21 5/8"x35 13/16"	100179778 L179703019	G-194	1 x Cj 1 x Pal	-	218,72 x Cj 218,72 x Pal
Washbasin Noir / Base Blanc	74.5x55x91 cm 29 5/16"x21 5/8"x35 13/16"	100179766 L179703006	G-194	1 x Cj 1 x Pal	-	218,72 x Cj 218,72 x Pal

Qmax L/min=12 l/min (Pressure/Presión/Pression= 3 bar).



Casquillo Desagüe 2Cm Cromo
100043169 - N899393001
NOKEN



Vaciador Fijo Sin Rebosadero Cromo
100040383 - N299606001
NOKEN



Stone waste cover / Embellecedor Piedra / Élément Décoratif Pierre
 Hidden-drain pedestals are available on order in the same material and with the same finish as that used for the wash basin. / Los embellecedores del desagüe pueden realizarse bajo pedido con el mismo material y acabado que el lavabo. / Sur demande, les éléments décoratifs du drain peuvent être fabriqués dans le même matériel et avec les mêmes nitions que le lavabo.
 (See page / Ver página / Voir page 139).

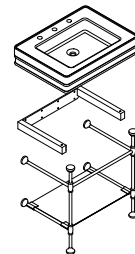
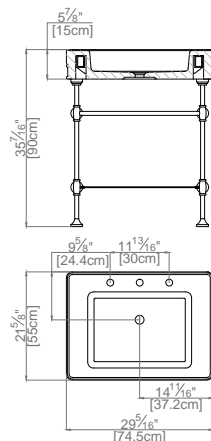

The set includes / El conjunto incluye / L'ensemble comprend les éléments suivants:
 -Wash basin / Lavabo / Lavabo.
 -Bracket / Escuadra de sujeción / Équerre de fixation.
 -Screws / Tornillería / Visserie.
 -Maintenance kit / Kit de mantenimiento / Kit d'entretien.

Saint Germain Structure



Description	Format	Codes	Group	Pcs	m2	Kg
Blanc	74.5x55 cm 29 5/16"x21 5/8"x35 7/16"	100179774 L179703023	G-193	1 x Cj 1 x Pal	-	129,39 x Cj 129,39 x Pal
Noir	74.5x55 cm 29 5/16"x21 5/8"x35 7/16"	100179775 L179703004	G-193	1 x Cj 1 x Pal	-	129,39 x Cj 129,39 x Pal

Qmax L/min=12 l/min (Pressure/Presión/Pression= 3 bar).



Casquillo Desagüe 2Cm Cromo
100043169 - N899393001
NOKEN



Vaciador Fijo Sin Rebosadero Cromo
100040383 - N299606001
NOKEN



Stone waste cover / Embellecedor Piedra / Élément Décoratif Pierre
 Hidden-drain pedestals are available on order in the same material and with the same finish as that used for the wash basin. / Los embellecedores del desagüe pueden realizarse bajo pedido con el mismo material y acabado que el lavabo. / Sur demande, les éléments décoratifs du drain peuvent être fabriqués dans le même matériel et avec les mêmes nitions que le lavabo.
 (See page / Ver página / Voir page 139).

SAINT GERMAIN

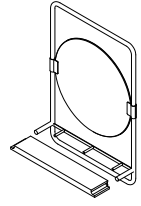
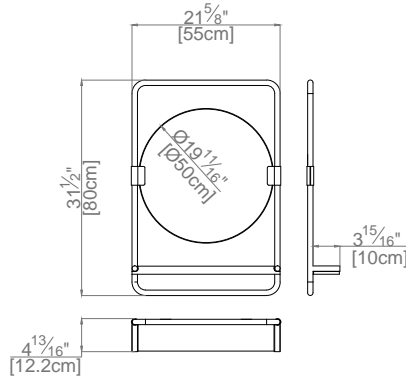

The set includes / El conjunto incluye /
L'ensemble comprend les éléments suivants:
-Mirrors / Espejo / Miroir:
-Screws / Tornillería / Visserie.

Saint Germain Espejo Étagère



GLOSS

Description	Format	Codes	Group	Pcs	m2	Kg
Blanc	55x80 cm	I00179810	G-181	I x Cj	-	9,86 x Cj
	21 5/8"x31 1/2"x4 13/16"	L179703035		I x Pal	-	9,86 x Pal
Noir	55x80 cm	I00179792	G-181	I x Cj	-	9,86 x Cj
	21 5/8"x31 1/2"x4 13/16"	L179703028		I x Pal	-	9,86 x Pal

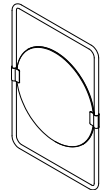
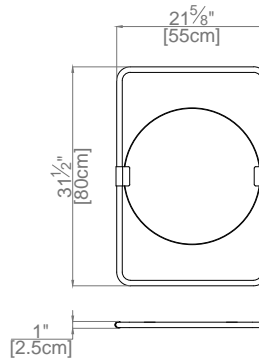

The set includes / El conjunto incluye /
L'ensemble comprend les éléments suivants:
-Mirrors / Espejo / Miroir:
-Screws / Tornillería / Visserie.

Saint Germain Espejo Tour



GLOSS

Description	Format	Codes	Group	Pcs	m2	Kg
Saint Germain Espejo Tour	55x80x2,5 cm	I00179772	G-178	I x Cj	-	7,79 x Cj
	21 5/8"x31 1/2"x1"	L179703031		I x Pal	-	7,79 x Pal

SAINT GERMAIN

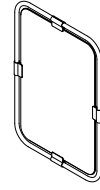
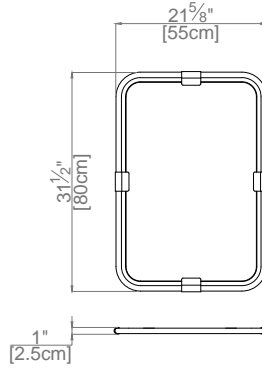

The set includes / El conjunto incluye /
L'ensemble comprend les éléments suivants:
-Mirrors / Espejo / Miroir.
-Screws / Tornillería / Visserie.

Bathrooms

Saint Germain Espejo Place



GLOSS

Description	Format	Codes	Group	Pcs	m2	Kg
Saint Germain Espejo Place	55x80x2,5 cm 21 5/8"x31 1/2"x1"	100179811 L179703020	G-178	1 x Cj 1 x Pal	- -	7,79 x Cj 7,79 x Pal



Wall Coverings Calpe Nieve, Javea Black / Complementary products Saint Germain Totem Crochet Blanc - Noir



Complementary products Saint Denis Lavabo Noir



SAINT DENIS

.....

by Lázaro Rosa-Violán

SAINT DENIS

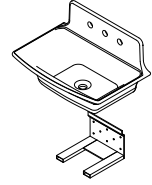
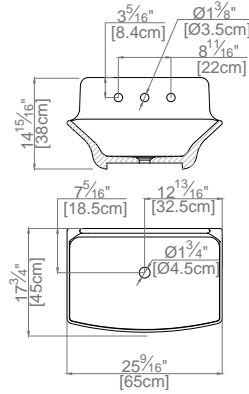

The set includes / El conjunto incluye / L'ensemble comprend les éléments suivants:
 -Wash basin / Lavabo / Lavabo.
 -Bracket / Escuadra de sujeción / Équerre de fixation.
 -Screws / Tornillería / Visserie.
 -Maintenance kit / Kit de mantenimiento / Kit d'entretien.

Saint Denis Lavabo



Description	Format	Codes	Group	Pcs	m2	Kg
Blanc	65x45x38 cm	100179791	G-192	I x Cj	-	187,20 x Cj
	25 9/16"x17 3/4"x14 15/16"	L179703025		I x Pal	-	187,20 x Pal
Noir	65x45x38 cm	100179789	G-192	I x Cj	-	187,20 x Cj
	25 9/16"x17 3/4"x14 15/16"	L179703021		I x Pal	-	187,20 x Pal

Qmax L/min=12 l/min (Pressure/Presión/Pression= 3 bar).



Casquillo Desagüe 2Cm Cromo
 100043169 - N899393001
 NOKEN



Vaciador Fijo Sin Rebosadero Cromo
 100040383 - N299606001
 NOKEN



Stone waste cover / Embellecedor Piedra / Élément Décoratif Pierre
 Hidden-drain pedestals are available on order in the same material and with the same finish as that used for the wash basin. / Los embellecedores del desagüe pueden realizarse bajo pedido con el mismo material y acabado que el lavabo. / Sur demande, les éléments décoratifs du drain peuvent être fabriqués dans le même matériel et avec les mêmes finitions que le lavabo.
 (See page / Ver página / Voir page 139).

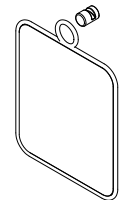
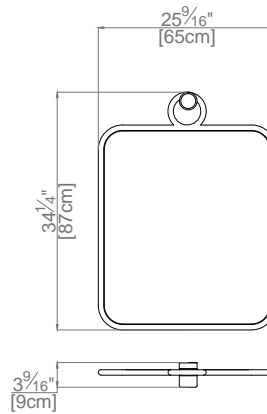

The set includes / El conjunto incluye / L'ensemble comprend les éléments suivants:
 -Mirrors / Espejo / Miroir.
 -Screws / Tornillería / Visserie.
 -Natural Stone hook / Percha de piedra / Support en pierre.

Saint Denis Espejo Place



Description	Format	Codes	Group	Pcs	m2	Kg
Blanc	65x87x9 cm	100179749	G-181	I x Cj	-	40,97 x Cj
	25 9/16"x34 1/4"x3 9/16"	L179703022		I x Pal	-	40,97 x Pal
Noir	65x87x9 cm	100179765	G-181	I x Cj	-	40,97 x Cj
	25 9/16"x34 1/4"x3 9/16"	L179703032		I x Pal	-	40,97 x Pal

SAINT DENIS

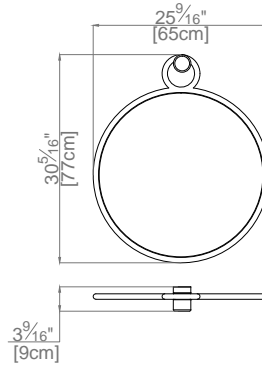

The set includes / El conjunto incluye /
L'ensemble comprend les éléments suivants:
-Mirrors / Espejo / Miroir.
-Screws / Tornillería / Visserie.
-Natural Stone hook / Percha de piedra /
Support en pierre.

Bathrooms

Saint Denis Espejo Tour



GLOSS

Description	Format	Codes	Group	Pcs	m2	Kg
Blanc	65x77x9 cm	100179800	G-181	1 x Cj	-	36,26 x Cj
	21 5/8"x31 1/2"x1"	L179703029		1 x Pal	-	36,26 x Pal
Noir	65x77x9 cm	100179767	G-181	1 x Cj	-	36,26 x Cj
	21 5/8"x31 1/2"x1"	L179703030		1 x Pal	-	36,26 x Pal



Floor Coverings Persian White Pulido / Wall Coverings Persian White Classico, Retro Blanco / Complementary products Vintage S Persian White-Blanco, Espejo Vintage S Blanco

VINTAGE

.....

by Yonoh



VINTAGE

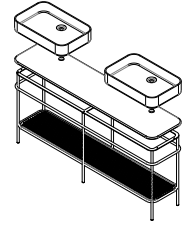
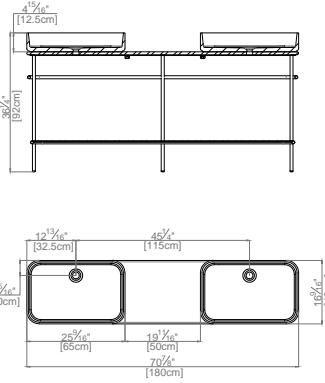

The set includes / El conjunto incluye / L'ensemble comprend les éléments suivants:
 -Wash basin / Lavabo / Lavabo.
 -Metal Structure / Estructura Metal / Structure métallique
 -Stone countertop / Encimera de piedra / Plan de toilette en pierre.
 -Screws / Tornillería / Visserie.
 -Maintenance kit / Kit de mantenimiento / Kit d'entretien.

Vintage L



Description	Format	Codes	Group	Pcs	m2	Kg
Crema Italia / Blanco	180x42x92 cm	100185145	G-194	1 x Cj	-	153,37 x Cj
	70 7/8"x16 9/16"x36 1/4"	L179703159		1 x Pal	-	153,34 x Pal
Crema Italia / Negro	180x42x92 cm	100185654	G-194	1 x Cj	-	153,37 x Cj
	70 7/8"x16 9/16"x36 1/4"	L179703095		1 x Pal	-	153,34 x Pal
Habana Dark / Blanco	180x42x92 cm	100185163	G-194	1 x Cj	-	153,37 x Cj
	70 7/8"x16 9/16"x36 1/4"	L179703160		1 x Pal	-	153,34 x Pal
Habana Dark / Negro	180x42x92 cm	100185635	G-194	1 x Cj	-	153,37 x Cj
	70 7/8"x16 9/16"x36 1/4"	L179703096		1 x Pal	-	153,34 x Pal
Persian White / Blanco	180x42x92 cm	100185164	G-194	1 x Cj	-	153,37 x Cj
	70 7/8"x16 9/16"x36 1/4"	L179703126		1 x Pal	-	153,34 x Pal
Persian White / Negro	180x42x92 cm	100185672	G-194	1 x Cj	-	153,37 x Cj
	70 7/8"x16 9/16"x36 1/4"	L179703097		1 x Pal	-	153,34 x Pal

Qmax L/min=12 l/min (Pressure/Presión/Pression= 3 bar).



Casquillo Desagüe 2Cm Cromo
 100043169 - N899393001
 NOKEN



Vaciador Fijo Sin Rebosadero Cromo
 100040383 - N299606001
 NOKEN



Stone waste cover / Embellecedor Piedra / Élément Décoratif Pierre
 Hidden-drain pedestals are available on order in the same material and with the same finish as that used for the wash basin. / Los embellecedores del desagüe pueden realizarse bajo pedido con el mismo material y acabado que el lavabo. / Sur demande, les éléments décoratifs du drain peuvent être fabriqués dans le même matériel et avec les mêmes finitions que le lavabo.
 (See page / Ver página / Voir page 139).

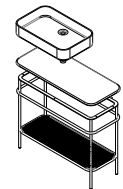
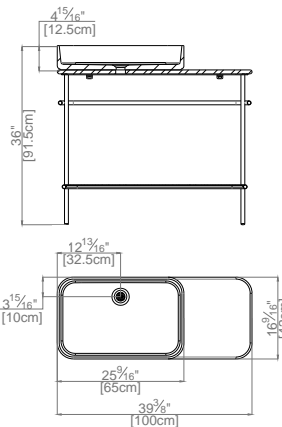

The set includes / El conjunto incluye / L'ensemble comprend les éléments suivants:
 -Wash basin / Lavabo / Lavabo.
 -Metal Structure / Estructura Metal / Structure métallique
 -Stone countertop / Encimera de piedra / Plan de toilette en pierre.
 -Screws / Tornillería / Visserie.
 -Maintenance kit / Kit de mantenimiento / Kit d'entretien.

Vintage S



Description	Format	Codes	Group	Pcs	m2	Kg
Crema Italia / Blanco	100x42x91.5 cm	100185146	G-188	1 x Cj	-	84,28 x Cj
	39 3/8"x16 9/16"x36"	L179703161		1 x Pal	-	84,28 x Pal
Crema Italia / Negro	100x42x91.5 cm	100185636	G-188	1 x Cj	-	84,28 x Cj
	39 3/8"x16 9/16"x36"	L179703098		1 x Pal	-	84,28 x Pal
Habana Dark / Blanco	100x42x91.5 cm	100185156	G-188	1 x Cj	-	84,28 x Cj
	39 3/8"x16 9/16"x36"	L179703162		1 x Pal	-	84,28 x Pal
Habana Dark / Negro	100x42x91.5 cm	100185673	G-188	1 x Cj	-	84,28 x Cj
	39 3/8"x16 9/16"x36"	L179703094		1 x Pal	-	84,28 x Pal
Persian White / Blanco	100x42x91.5 cm	100185125	G-188	1 x Cj	-	84,28 x Cj
	39 3/8"x16 9/16"x36"	L179703125		1 x Pal	-	84,28 x Pal
Persian White / Negro	100x42x91.5 cm	100185662	G-188	1 x Cj	-	84,28 x Cj
	39 3/8"x16 9/16"x36"	L179703099		1 x Pal	-	84,28 x Pal

Qmax L/min=12 l/min (Pressure/Presión/Pression= 3 bar).



Casquillo Desagüe 2Cm Cromo
 100043169 - N899393001
 NOKEN



Vaciador Fijo Sin Rebosadero Cromo
 100040383 - N299606001
 NOKEN



Stone waste cover / Embellecedor Piedra / Élément Décoratif Pierre
 Hidden-drain pedestals are available on order in the same material and with the same finish as that used for the wash basin. / Los embellecedores del desagüe pueden realizarse bajo pedido con el mismo material y acabado que el lavabo. / Sur demande, les éléments décoratifs du drain peuvent être fabriqués dans le même matériel et avec les mêmes finitions que le lavabo.
 (See page / Ver página / Voir page 139).

VINTAGE

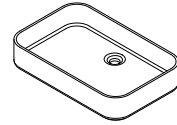
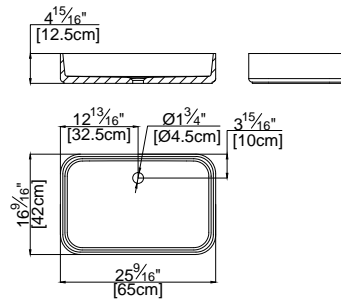

The set includes / El conjunto incluye / L'ensemble comprend les éléments suivants:
 -Wash basin / Lavabo / Lavabo.
 -Maintenance kit / Kit de mantenimiento / Kit d'entretien.

Vintage



MATT



WASHBASIN ON SUPPORT



BIOPROT



Casquillo Desagüe 2Cm Cromo
 100043169 - N899393001
 NOKEN



Vaciador Fijo Sin Rebosadero Cromo
 100040383 - N299606001
 NOKEN



Stone waste cover / Embellecedor Piedra / Élément Décoratif Pierre

Hidden-drain pedestals are available on order in the same material and with the same finish as that used for the wash basin. / Los embellecedores del desagüe pueden realizarse bajo pedido con el mismo material y acabado que el lavabo. / Sur demande, les éléments décoratifs du drain peuvent être fabriqués dans le même matériel et avec les mêmes finitions que le lavabo.
 (See page / Ver página / Voir page 139).

Description	Format	Codes	Group	Pcs	m2	Kg
Vintage Persian White	65x42x12.5 cm	100180582	G-186	1 x Cj	-	29,98 x Cj
	25 5/8" x 16 2/4" x 4 7/8"	L179703039		1 x Pal	-	29,98 x Pal
Vintage Crema Italia	65x42x12.5 cm	100180562	G-186	1 x Cj	-	29,98 x Cj
	25 5/8" x 16 2/4" x 4 7/8"	L179703037		1 x Pal	-	29,98 x Pal
Vintage Habana Dark	65x42x12.5 cm	100180581	G-186	1 x Cj	-	29,98 x Cj
	25 5/8" x 16 2/4" x 4 7/8"	L179703038		1 x Pal	-	29,98 x Pal

Qmax U/min=12 l/min (Pressure/Presión/Pression= 3 bar).



Floor Coverings Habana Grey Pulido / Wall Coverings Habana Grey Classico, Airslate Forest / Complementary products Vintage L Habana Dark-Negro, Espejo Vintage L Negro

VINTAGE

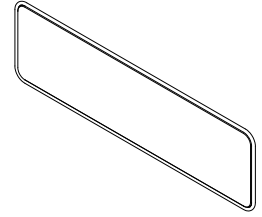
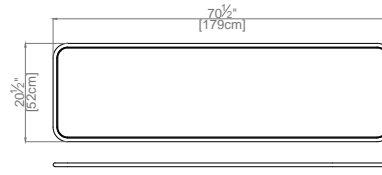
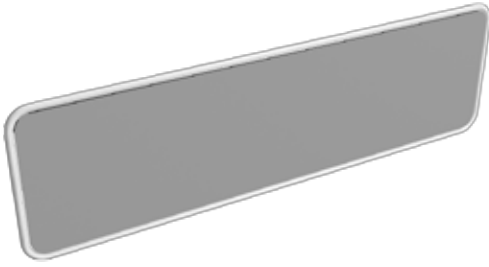

L'ensemble comprend les éléments suivants:
-Mirrors / Espejo / Miroir.
-Screws / Tornillería / Visserie.

Vintage Espejo L



Description	Format	Codes	Group	Pcs	m2	Kg
Blanco	179x52 cm 70 1/2"x20 1/2"	100187395 L179703163	G-175	1 x Cj 10 x Pal	- -	7,77 x Cj 77,76 x Pal
Negro	179x52 cm 70 1/2"x20 1/2"	100187416 L179703164	G-175	1 x Cj 10 x Pal	- -	7,77 x Cj 77,76 x Pal

Steam free mirror with built-in demister / Espejo con Sistema Antivaho incorporado que evita que se empañe. / Miroir avec système anti-buée intégré qui empêche que s'embue.

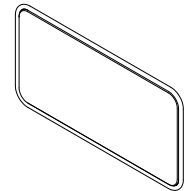
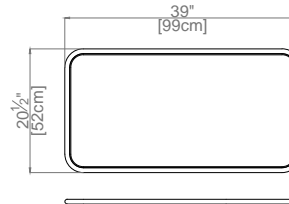
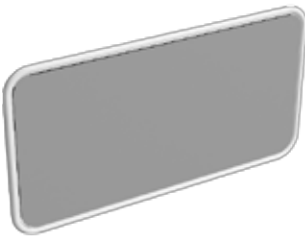

L'ensemble comprend les éléments suivants:
-Mirrors / Espejo / Miroir.
-Screws / Tornillería / Visserie.

Vintage Espejo S



Description	Format	Codes	Group	Pcs	m2	Kg
Blanco	99x52 cm 39"x20 1/2"	100187396 L179703166	G-173	1 x Cj 10 x Pal	- -	4,30 x Cj 43,01 x Pal
Negro	99x52 cm 39"x20 1/2"	100187417 L179703165	G-173	1 x Cj 10 x Pal	- -	4,30 x Cj 43,01 x Pal

Steam free mirror with built-in demister / Espejo con Sistema Antivaho incorporado que evita que se empañe. / Miroir avec système anti-buée intégré qui empêche que s'embue.

VINTAGE



Floor Coverings Arctic White Classico / Wall Coverings Arctic White Classico, Gravity Aluminium Hexagon Rose Gold / Complementary products Vintage S Persian White - Blanco



Complementary products TONO Elementes Stone Basin Wall Mounted 800 Calgary, TONO Elementes Stone Mirror 800x1000 Calgary

TONO

.....

by Foster + Partners



TONO

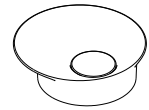
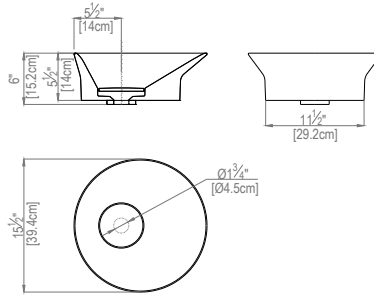

The set includes / El conjunto incluye /
L'ensemble comprend les éléments suivants:
-Wash basin / Lavabo / Lavabo.
-Stone waste cover / Embellecedor piedra /
Élément décoratif Pierre.

Stone Basin Countertop 400 Angled



Description	Format	Codes	Group	Pcs	m2	Kg
Habana Dark Classico	39,4x39,4x15,2 cm	100200534	G-186	1 x Cj	-	47,11 x Cj
	15 1/2"x15 1/2"x6"	L179703289		1 x Pal	-	47,11 x Pal
Capuccino Grey Classico	39,4x39,4x15,2 cm	100200552	G-185	1 x Cj	-	47,11 x Pal
	15 1/2"x15 1/2"x6"	L179703287		1 x Pal	-	47,11 x Pal
Calgary Classico	39,4x39,4x15,2 cm	100200561	G-185	1 x Cj	-	47,11 x Pal
	15 1/2"x15 1/2"x6"	L179703288		1 x Pal	-	47,11 x Pal

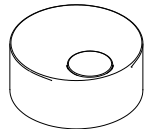
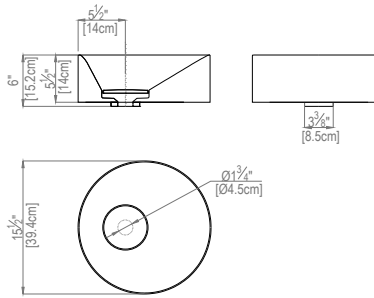

The set includes / El conjunto incluye /
L'ensemble comprend les éléments suivants:
-Wash basin / Lavabo / Lavabo.
-Stone waste cover / Embellecedor piedra /
Élément décoratif Pierre.

Stone Basin Countertop 400 Straight



Description	Format	Codes	Group	Pcs	m2	Kg
Habana Dark Classico	39,4x39,4x15,2 cm	100200533	G-186	1 x Cj	-	47,11 x Cj
	15 1/2"x15 1/2"x6"	L179703286		1 x Pal	-	47,11 x Pal
Capuccino Grey Classico	39,4x39,4x15,2 cm	100200551	G-185	1 x Cj	-	47,11 x Pal
	15 1/2"x15 1/2"x6"	L179703285		1 x Pal	-	47,11 x Pal
Calgary Classico	39,4x39,4x15,2 cm	100200532	G-185	1 x Cj	-	47,11 x Pal
	15 1/2"x15 1/2"x6"	L179703284		1 x Pal	-	47,11 x Pal

TONO

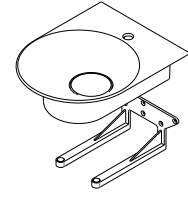
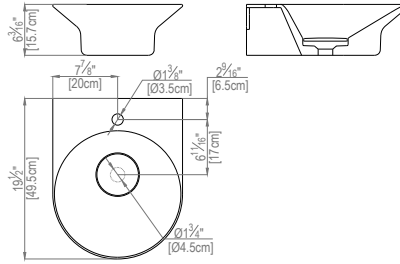

The set includes / El conjunto incluye / L'ensemble comprend les éléments suivants:
 -Wash basin / Lavabo / Lavabo.
 -Stone waste cover / Embellecedor piedra / Élément décoratif Pierre.
 -Bracket / Escuadra de sujeción / Équerre de fixation.
 -Screws / Tornillería / Visserie.

Stone Basin Wall Mounted 400



MATT



WALL-MOUNTED
WASHBASIN



BIOPROT

Description	Format	Codes	Group	Pcs	m2	Kg
Habana Dark Classico	49.5x40x15.7 cm	100200562	G-192	1 x Cj	-	64,30 x Cj
	19 1/2"x15 3/4"x6 3/16"	L179703292		1 x Pal	-	64,30 x Pal
Capuccino Grey Classico	49.5x40x15.7 cm	100200535	G-190	1 x Cj	-	64,30 x Cj
	19 1/2"x15 3/4"x6 3/16"	L179703291		1 x Pal	-	64,30 x Pal
Calgary Classico	49.5x40x15.7 cm	100200545	G-190	1 x Cj	-	64,30 x Cj
	19 1/2"x15 3/4"x6 3/16"	L179703290		1 x Pal	-	64,30 x Pal



Floor Coverings Patagonia Home / Wall Coverings Patagonia Home / Complementary products Stone Basin Countertop 400 Angled Capuccino Grey Classico

TONO

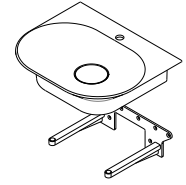
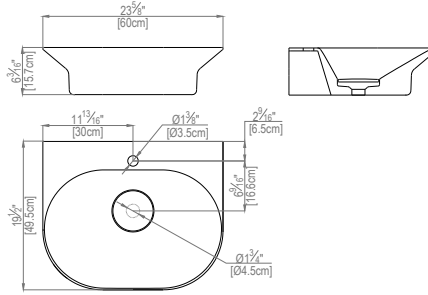

The set includes / El conjunto incluye / L'ensemble comprend les éléments suivants:

- Wash basin / Lavabo / Lavabo.
- Stone waste cover / Embellecedor piedra / Élément décoratif Pierre.
- Bracket / Escuadra de sujeción / Équerre de fixation.
- Screws / Tornillería / Visserie.

Stone Basin Wall Mounted 600



Description	Format	Codes	Group	Pcs	m2	Kg
Habana Dark Classico	49,5x60x15,7 cm	100200553	G-194	1 x Cj	-	94,79 x Cj
	19 1/2"x23 5/8"x6 3/16"	L179703295		1 x Pal	-	94,79 x Pal
Capuccino Grey Classico	49,5x60x15,7 cm	100200546	G-193	1 x Cj	-	94,79 x Cj
	19 1/2"x23 5/8"x6 3/16"	L179703294		1 x Pal	-	94,79 x Pal
Calgary Classico	49,5x60x15,7 cm	100200536	G-193	1 x Cj	-	94,79 x Cj
	19 1/2"x23 5/8"x6 3/16"	L179703293		1 x Pal	-	94,79 x Pal

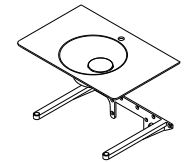
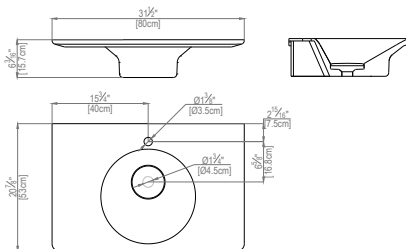

The set includes / El conjunto incluye / L'ensemble comprend les éléments suivants:

- Wash basin / Lavabo / Lavabo.
- Stone waste cover / Embellecedor piedra / Élément décoratif Pierre.
- Bracket / Escuadra de sujeción / Équerre de fixation.
- Screws / Tornillería / Visserie.

Stone Basin Wall Mounted 800



Description	Format	Codes	Group	Pcs	m2	Kg
Habana Dark Classico	53x80x15,7 cm	100200538	G-195	1 x Cj	-	132,91 x Cj
	20 7/8"x31 1/2"x6 3/16"	L108043751		1 x Pal	-	132,91 x Pal
Capuccino Grey Classico	53x80x15,7 cm	100200547	G-194	1 x Cj	-	132,91 x Cj
	20 7/8"x31 1/2"x6 3/16"	L108043741		1 x Pal	-	132,91 x Pal
Calgary Classico	53x80x15,7 cm	100200537	G-194	1 x Cj	-	132,91 x Cj
	20 7/8"x31 1/2"x6 3/16"	L108043731		1 x Pal	-	132,91 x Pal

TONO

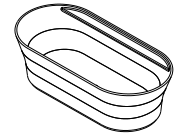
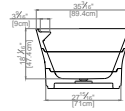
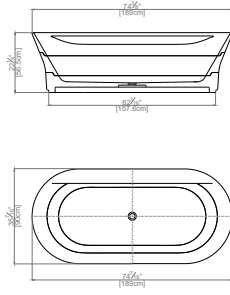

The set includes / El conjunto incluye / L'ensemble comprend les éléments suivants:
 -Bathtub / Bañera / Baignoires.
 -Installation kit / Kit de instalación / Kit d'installation.
 -Gasket / Junta de montaje / Joint de montage.
 -Maintenance kit / Kit de mantenimiento / Kit d'entretien.

Stone Freestanding Bathtub



Description	Format	Codes	Group	Pcs	m2	Kg
Habana Dark Classico	90x189x56,5 cm 35 7/16"x74 7/16"x22 1/4"	100200735 L173300511	G-197	1 x Cj 1 x Pal	-	630 x Cj 630 x Pal
Capuccino Grey Classico	90x189x56,5 cm 35 7/16"x74 7/16"x22 1/4"	100200743 L173300510	G-197	1 x Cj 1 x Pal	-	630 x Cj 630 x Pal
Calgary Classico	90x189x56,5 cm 35 7/16"x74 7/16"x22 1/4"	100200742 L173300509	G-197	1 x Cj 1 x Pal	-	630 x Cj 630 x Pal



Complementary products Stone Freestanding Bathtub Habana Dark Classico

TONO

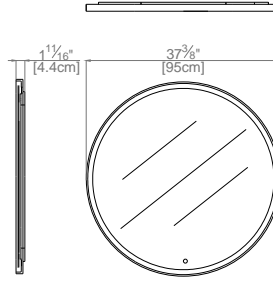

The set includes / El conjunto incluye / L'ensemble comprend les éléments suivants:
-Mirrors / Espejo / Miroir.
-Screws / Tornillería / Visserie.



Mirror with LED lit perimeter / Iluminado perimetralmente con LEDs. / Illuminé sur le périmètre avec des LEDs. LEDs 2800°K. 9.8V.

Stone Mirror D 950



Description	Format	Codes	Group	Pcs	m2	Kg
Habana Dark Classico	95x95x4,4 cm	100200583	G-192	1 x Cj	-	21.07 x Cj
	37 3/8"x37 3/8"x1 11/16"	L179703307		1 x Pal	-	21.07 x Pal
Capuccino Grey Classico	95x95x4,4 cm	100200582	G-190	1 x Cj	-	21.07 x Cj
	37 3/8"x37 3/8"x1 11/16"	L179703306		1 x Pal	-	21.07 x Pal
Calgary Classico	95x95x4,4 cm	100200581	G-190	1 x Cj	-	21.07 x Cj
	37 3/8"x37 3/8"x1 11/16"	L179703305		1 x Pal	-	21.07 x Pal

Steam free mirror with built-in demister / Espejo con Sistema Antivaho incorporado que evita que se empañe. / Miroir avec système anti-buée intégré qui empêche que s'embue.

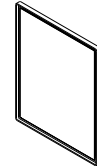
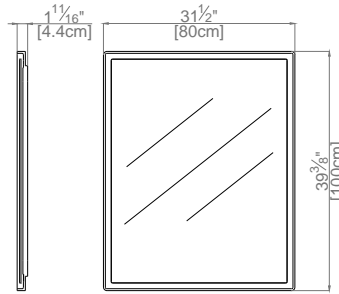

The set includes / El conjunto incluye / L'ensemble comprend les éléments suivants:
-Mirrors / Espejo / Miroir.
-Screws / Tornillería / Visserie.



Mirror with LED lit perimeter / Iluminado perimetralmente con LEDs. / Illuminé sur le périmètre avec des LEDs. LEDs 2800°K. 9.8V.

Stone Mirror 800x1000



Description	Format	Codes	Group	Pcs	m2	Kg
Habana Dark Classico	80x100x4,4 cm	100200565	G-190	1 x Cj	-	25.76 x Cj
	31 1/2"x39 3/8"x1 11/16"	L179703304		1 x Pal	-	25.76 x Pal
Capuccino Grey Classico	80x100x4,4 cm	100200580	G-189	1 x Cj	-	25.76 x Cj
	31 1/2"x39 3/8"x1 11/16"	L179703303		1 x Pal	-	25.76 x Pal
Calgary Classico	80x100x4,4 cm	100200570	G-189	1 x Cj	-	25.76 x Cj
	31 1/2"x39 3/8"x1 11/16"	L179703302		1 x Pal	-	25.76 x Pal

Steam free mirror with built-in demister / Espejo con Sistema Antivaho incorporado que evita que se empañe. / Miroir avec système anti-buée intégré qui empêche que s'embue.

TONO

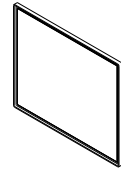
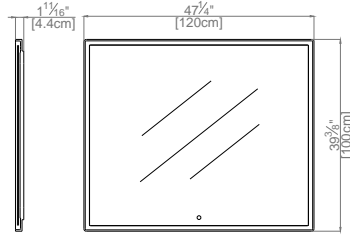

The set includes / El conjunto incluye /
L'ensemble comprend les éléments suivants:
-Mirrors / Espejo / Miroir.
-Screws / Tornillería / Visserie.



Mirror with LED lit perimeter / Iluminado
perimetralmente con LEDs. / Illuminé sur le
périmètre avec des LEDs. LEDs 2800°K. 9.8 V.

Stone Mirror 1200x1000



MATT

Description	Format	Codes	Group	Pcs	m2	Kg
Habana Dark Classico	120x100x4,4 cm 47 1/4"x39 3/8"x1 1/16"	100200539 L179703298	G-192	1 x Cj 1 x Pal	-	39,81 x Cj 39,81 x Pal
Capuccino Grey Classico	120x100x4,4 cm 47 1/4"x39 3/8"x1 1/16"	100200564 L179703297	G-190	1 x Cj 1 x Pal	-	39,81 x Cj 39,81 x Pal
Calgary Classico	120x100x4,4 cm 47 1/4"x39 3/8"x1 1/16"	100200563 L179703296	G-190	1 x Cj 1 x Pal	-	39,81 x Cj 39,81 x Pal

Steam free mirror with built-in demister / Espejo
con Sistema Antivaho incorporado que evita que se
empañe. / Miroir avec système anti-buée intégré qui
empêche que s'embue.

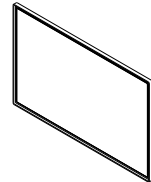
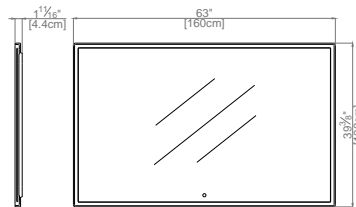

The set includes / El conjunto incluye /
L'ensemble comprend les éléments suivants:
-Mirrors / Espejo / Miroir.
-Screws / Tornillería / Visserie.



Mirror with LED lit perimeter / Iluminado
perimetralmente con LEDs. / Illuminé sur le
périmètre avec des LEDs. LEDs 2800°K. 9.8 V.

Stone Mirror 1600x1000



MATT

Description	Format	Codes	Group	Pcs	m2	Kg
Habana Dark Classico	160x100x4,4 cm 63"x39 3/8"x1 1/16"	100200549 L179703301	G-194	1 x Cj 1 x Pal	-	51,52 x Cj 51,52 x Pal
Capuccino Grey Classico	160x100x4,4 cm 63"x39 3/8"x1 1/16"	100200548 L179703300	G-192	1 x Cj 1 x Pal	-	51,52 x Cj 51,52 x Pal
Calgary Classico	160x100x4,4 cm 63"x39 3/8"x1 1/16"	100200554 L179703299	G-192	1 x Cj 1 x Pal	-	51,52 x Cj 51,52 x Pal

Steam free mirror with built-in demister / Espejo
con Sistema Antivaho incorporado que evita que se
empañe. / Miroir avec système anti-buée intégré qui
empêche que s'embue.

FINISHES / ACABADOS / ACABADOS

Bathrooms

Persian White



Blanco Almería



Grey Stone



Crema Italia



Beige



Habana Brown. Only Azrama Collection / Sólo colección Azrama



FINISHES / ACABADOS / ACABADOS

Blanc. Only Saint Denis & Saint Germain Collection / Sólo colección Saint Denis y Saint Germain



A-cero Dark. Only Spirit Collection / Sólo colección Spirit



A-cero Gloss / Calgary. Only Spirit & TONO Collection / Sólo colección Spirit y TONO

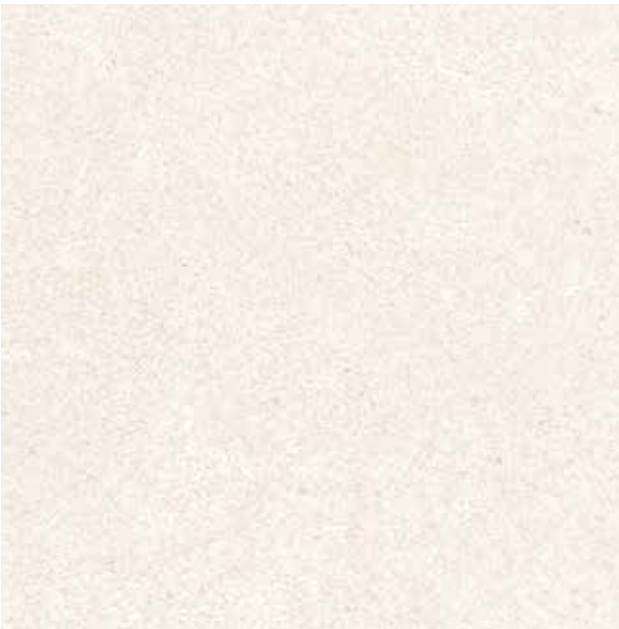

Noir. Only Saint Denis & Saint Germain Collection / Sólo colección Saint Denis y Saint Germain

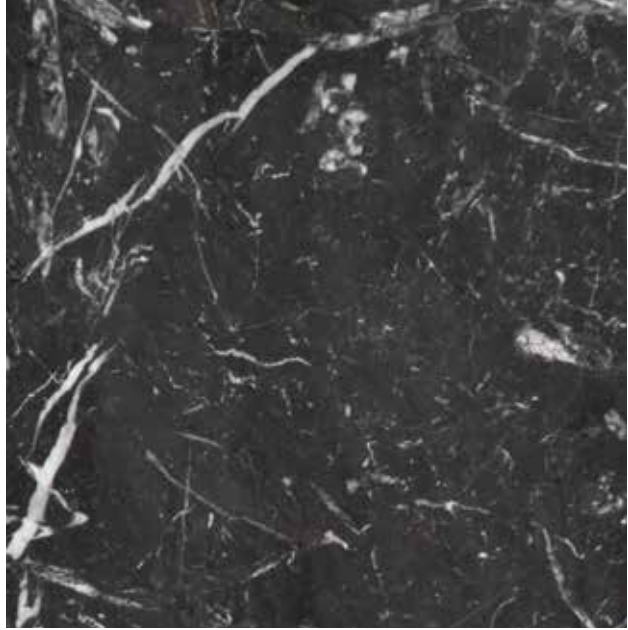

Habana Dark



Capuccino Grey. Only TONO Collection / Sólo colección TONO



FINISHES / ACABADOS / ACABADOS

Bathrooms

Pampa . Only worktops / Sólo para encimeras



Bhutan. Only worktops / Sólo para encimeras



Nogal Warm



Patagonia. Only worktops / Sólo para encimeras

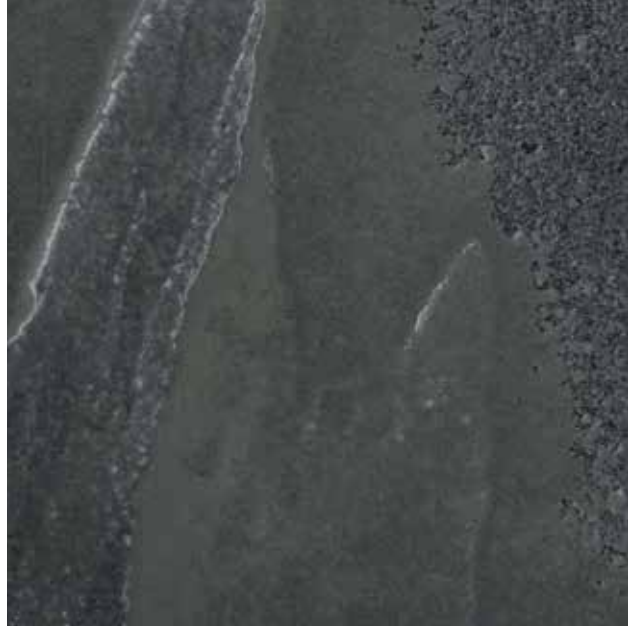

Tukuman. Only worktops / Sólo para encimeras



Nogal Intense



FINISHES / ACABADOS / ACABADOS

Roble Sunset



Roble Cloudy



Roble Centza. Only Spirit Collection / Sólo colección Spirit



Roble Intenso. Only Spirit Collection / Sólo colección Spirit



Nogal Americano. Only Menhir Collection / Sólo colección Menhir



Roble Antracita. Only Menhir Collection / Sólo colección Menhir



FINISHES / ACABADOS / ACABADOS

Bathrooms

Roble Natural. Only Menhir Collection / Sólo colección Menhir.



Roble Earth. Only Minim Wood Collection / Sólo colección Minim Wood



Roble Snow. Only Minim Wood Collection / Sólo colección Minim Wood



Roble Beige. Only Minim Wood Collection / Sólo colección Minim Wood



Roble Grey. Only Minim Wood Collection / Sólo colección Minim Wood



Iroko. Only Azrama Collection / Sólo colección Azrama



FINISHES / ACABADOS / ACABADOS



Complementary products Minim Wood Lavabo + Encimera Roble Earth - Habana Dark

WARRANTY

All our products are top quality and hold the guarantee obtained with the ISO 9001 certification and CE Marking, Declaration of Conformity. In addition, the department of quality at L'Antic Colonial, S.A conducts permanent quality controls of its products. All products are guaranteed against any production defects, in normal conditions of use and with correct assembly and installation for a period of TWO YEARS, from the delivery date to the first user. The goods should be carefully inspected on delivery. Any fault, defect or breakage observed, caused during transportation, should be recorded on the transport agency delivery note. In the case of units supplied in promotional offers, projects, etc., the guarantee period will start on the product supply date. This guarantee does not apply to those products which have been stored, fitted or installed incorrectly, misused, or cleaned using unsuitable cleaning products or methods. This guarantee does not apply to those products that have been used for public use, outside or in corrosive environments.

The normal evolution and characteristics of the natural product are excluded. There may be slight differences of colour between the different elements and differences in tone or grain. In addition, if the products are compared at different moments, the time elapsed and the weather conditions may cause variations in colour and/or tone.

While this guarantee remains valid, L'Antic Colonial reserves the right, without prior notification, to modify the technical and design specifications of its products.

Conditions of guarantee:

- That the product was purchased from an Official Distributor.
- That it has not been altered since it left the factory.
- That the recommendations for use and maintenance have been observed.
- That the products have not been used, or exhibited for an indefinite period in any showroom. The guarantee period for these articles is 30 days.

NOTE: The guarantee document is applicable without prejudice to the rights of the consumers established under the applicable Law in each country, and with that established under European Community legislation.

MAINTENANCE

Maintenance is essential for removing dirt or stains that may have built up, acid attacks, renewing the product shine, etc. Correct maintenance guarantees a longer life for the product.

NATURAL STONE

Ordinary cleaning: A neutral pH high-powered cleaner such as Fila Cleaner is recommended, to ensure fast and efficient cleaning, without damaging the product treatment. Dilute a capful of Fila Cleaner in a bucket of warm water and mop the product. Rinsing is not necessary. To remove stains or acid attacks: In the event of stains or attacks by acid substances (lemon, coke, tomato juice, lime scale removers, wine, vinegar, etc.) that react with the natural stone, these can be removed using a suitable restoration kit available from L'Antic Colonial points of sale. To remove organic stains, dyes and felt-tip pen, use the Fila Sr/95 colour stain remover.

Renewing or increasing the degree of shine: To renew or increase the degree of shine, use the specific natural wax, FilaClassic. To apply correctly, first dilute the product, apply to the surface and after a few hours, gently wipe with a soft cloth to obtain the required shine.

WOOD USED IN THE UNITS

Dust with a soft cloth at least twice a week. Units must never be exposed to prolonged contact with water or extremely high conditions of humidity. Check that the bathroom is correctly ventilated. Wipe away any water spilt onto the surface, with a clean dry cloth as fast as possible to prevent moisture from penetrating into the product. Grease and oil stains can be easily removed with acetone.

Remember that to remove ordinary domestic dirt, abrasive soaps, steel wool, wax or polishers should not be used in the care and conservation of the product. A biodegradable cleaner that does not leave residue and does not require rinsing after application is ideal.

Avoid exposure to direct sunlight for prolonged periods of time. During the hours of maximum sunlight, use curtains or blinds to minimise the direct sunlight.

GLASS AND MIRRORS

Use a soft cloth moistened with alcohol. Avoid the use of abrasive materials that may harm or scratch the surface.

STAINLESS STEEL

Stainless steel is special steel known for its high resistance to knocks, scratches, light and corrosion. No special care is necessary but it is important not to use abrasive materials. Surfaces should be cleaned with a soft cloth and alcohol.

GARANTÍA

Todos nuestros productos son de primera calidad y cuentan con la garantía otorgada por la certificación ISO 9001 y la Declaración de conformidad relacionada con el Mercado CE. Así mismo, el departamento de calidad de L'Antic Colonial, S.A realiza un control permanentemente de la calidad de sus productos. Todos los productos están en garantía contra todo defecto de fabricación, en las condiciones normales de utilización y con un montaje e instalación correcto durante un periodo de DOS AÑOS, contando a partir de la fecha de entrega al primer usuario. Deberá ser revisada cuidadosamente la mercancía en el momento de la entrega. Toda anomalía, desperfecto o rotura detectada ocasionada en el transporte deberá ser anotada en el albarán de la agencia de transporte. En el caso de muebles suministrados en promociones, obras, etc..., el periodo de garantía contará a partir de la fecha de suministro de los mismos.

Esta garantía no se aplicará a aquellos productos que hayan sido almacenados, montados o instalados de forma incorrecta, o que se hayan utilizado de forma inapropiada, o que se hayan limpiado con métodos o productos de limpieza inadecuados. Esta garantía no se aplicará a aquellos productos que se hayan utilizado para uso público, en el exterior o en ambientes corrosivos.

Se excluyen de la garantía las características y evoluciones normales del producto natural, puede haber ligeras diferencias de tono entre los distintos elementos que lo componen y diferencias de matiz o veta. Además, si los productos se comparan en distintos momentos, el tiempo transcurrido y las condiciones climáticas pueden causar variaciones en color y/o tonalidad. Durante la vigencia de la presente garantía, L'Antic Colonial se reserva, sin previo aviso, la posibilidad de modificar las especificaciones técnicas y de diseño de sus productos.

Condiciones de garantía:

- Que el producto haya sido adquirido en un Distribuidor Oficial.
- Que no haya sido alterado desde su salida de fábrica.
- Que se hayan respetado todas las recomendaciones de uso y mantenimiento.
- Que los productos no hayan sido utilizados, ni hayan estado expuestos por tiempo indefinido en cualquier exposición, siendo el periodo de garantía de estos artículos de 30 días.

NOTA: El documento de garantía, será de aplicabilidad, sin perjuicio de los derechos de los consumidores establecidos por la Ley vigente en cada país, así como lo dispuesto en la normativa comunitaria europea.

MANTENIMIENTO

El mantenimiento tiene la importante finalidad de eliminar la suciedad, manchas que hayan podido penetrar ligeramente, ataques ácidos, renovar el brillo del material, etc. Un correcto mantenimiento garantiza una vida más larga al material.

PIEDRA NATURAL

Limpieza ordinaria: Se recomienda un limpiador con pH neutro y alto poder de limpieza como Fila Cleaner, así se garantiza una limpieza rápida y eficaz, respetando al mismo tiempo el tratamiento. Para ello se diluye un taponcito de Fila Cleaner en un cubo de agua tibia y luego se friega sin necesidad de aclarar. Para eliminar manchas o ataques ácidos: En caso de que se formen manchas por ataques de sustancias ácidas (limón, cola, zumo de tomate, anticales, vino, vinagre, etc.) que reaccionan con la piedra natural, se pueden eliminar utilizando un kit de restauración adecuado disponibles en los puntos de venta de L'Antic Colonial. Para eliminar manchas orgánicas, tintes y rotuladores se recomienda utilizar el quitamanchas de color Fila Sr/95.

Renovar o aumentar el grado de brillo: Para renovar o aumentar el grado de brillo existente, se recomienda utilizar la cera natural específica FilaClassic. Para una correcta aplicación se diluye previamente el producto, se aplica sobre la superficie y al cabo de unas horas se emplea con suavidad un paño para conseguir el brillo deseado.

MADERA DE LOS MUEBLES

Limpie el polvo con un paño suave por lo menos dos veces por semana. Los muebles no deben exponerse nunca a un contacto excesivo con agua o con una humedad extremadamente alta, por esta razón hay que asegurarse de que el baño cuenta con la ventilación adecuada. Si se derrama agua sobre la superficie, simplemente utilice un paño limpio y seco tan rápido como sea posible para evitar la penetración de la humedad. En cuanto a las manchas de grasa, estas se pueden eliminar fácilmente con acetona.

Debe tener en cuenta que la suciedad doméstica normal no deben utilizarse jabones abrasivos, estropajo de acero, cera o pulimentadora para su limpieza y conservación. Lo ideal es utilizar un limpiador biodegradable que no deje residuos y que no requiera enjuague después de la aplicación.

Evite la exposición directa de luz solar durante periodos de tiempo prolongados. Durante las horas de máxima luz solar, utilice cortinas o persianas para minimizar la luz solar directa.

CRISTAL Y ESPEJOS

Utilizar un paño suave humedecido con alcohol. Evitar la utilización de materiales abrasivos que pueden incidir o rayar la superficie.

ACERO INOXIDABLE

El acero inoxidable es un acero especial que se distingue por su elevada resistencia a los golpes, a las rayaduras, a la luz y a la corrosión. No se requieren cuidados particulares pero es importante no utilizar materiales abrasivos. Se recomienda limpiar las superficies con un paño suave y alcohol.

GARANTIE

Tous nos produits sont de première qualité et disposent de la garantie fournie par la certification ISO 9001 et la déclaration de conformité relative au marquage CE. De même, le département qualité de L'Antic Colonial, S.A réalise un contrôle permanent de la qualité de ses produits. Tous les produits sont garantis contre tout défaut de fabrication, dans les conditions normales d'utilisation et avec un montage et une installation correcte, pendant une période de DEUX ANS à partir de la date de livraison au premier utilisateur. La marchandise devra être vérifiée soigneusement au moment de la livraison. Toute anomalie, imperfection ou casse détectée et survenue pendant le transport devra apparaître sur le bon de livraison de l'agence de transport. Dans le cas de meubles fournis lors de promotions, sur chantier, etc., la période de garantie sera effective à partir de leur date de mise à disposition.

Cette garantie ne s'appliquera pas aux produits stockés, montés ou installés de manière incorrecte, ou utilisés de manière inappropriée, ou nettoyés avec des méthodes ou des produits de nettoyage inadaptés.

Cette garantie ne s'appliquera pas aux produits utilisés pour une utilisation publique, en extérieur ou dans des environnements corrosifs.

Sont exclues de la garantie les caractéristiques et évolutions normales du produit naturel ; les différents éléments le composant peuvent présenter de légères différences de ton, de nuance ou de veines. En outre, si les produits sont comparés à différents moments, le temps écoulé et les conditions climatiques peuvent provoquer des variations de couleur et/ou de tonalité.

Pendant toute la période de validité de la présente garantie, L'Antic Colonial se réserve la possibilité, sans avertissement préalable, de modifier les spécifications techniques et de conception de ses produits.

Conditions de garantie:

- Le produit doit avoir été acheté auprès d'un distributeur officiel.
- Il ne doit pas avoir été modifié depuis sa sortie d'usine.
- Toutes les recommandations d'utilisation et d'entretien doivent avoir été respectées.
- Les produits ne doivent pas avoir été utilisés ou exposés pour une durée indéfinie à une quelconque exposition, la période de garantie de ces articles étant de 30 jours.

REMARQUE: Le document de garantie sera applicable, sans préjudice des droits aux consommateurs définis par la loi en vigueur dans chaque pays, comme le veut la réglementation communautaire européenne.

ENTRETIEN

L'entretien a pour finalité indispensable d'éliminer la saleté, les taches qui auraient pu pénétrer légèrement, les attaques acides, de renouveler la brillance du matériau, etc. Un entretien correct garantit une durée de vie accrue du matériau.

PIERRE NATURELLE

Nettoyage ordinaire: Un nettoyant au pH neutre et à haut pouvoir nettoyant, comme le Fila Cleaner, est recommandé afin de garantir un nettoyage rapide et efficace, tout en respectant le traitement. Diluer pour cela un bouchon de Fila Cleaner dans un seau d'eau tiède, puis laver sans rincer. Pour éliminer des taches ou attaques acides: Si des taches se forment sous l'effet de l'attaque de substances acides (citron, coca cola, jus de tomate, anticalcaire, vin, vinaigre, etc.) qui réagissent avec la pierre naturelle, il est possible de les éliminer en utilisant un kit de restauration adéquat, disponible dans les points de vente de L'Antic Colonial. Pour éliminer des taches organiques, de teinture et de feutres, il est recommandé d'utiliser l'anti-taches de couleur Fila Sr/95.

Renouveler ou accroître le niveau de brillance: Pour renouveler ou accroître le niveau de brillance existant, il est recommandé d'utiliser la cire naturelle spécifique FilaClassis. Pour une application correcte, diluer d'abord le produit, puis l'appliquer sur la surface et, après quelques heures, utiliser avec soin un chiffon pour obtenir la brillance souhaitée.

BOIS DES MEUBLES

L'Nettoyer la poussière avec un chiffon doux au moins deux fois par semaine. Les meubles ne doivent jamais être exposés à un contact excessif avec l'eau ou une humidité extrême ; c'est pourquoi il faut s'assurer que la salle de bain dispose d'une ventilation adéquate. Si de l'eau est renversée sur la surface, il suffit d'utiliser un chiffon propre et sec le plus rapidement possible pour éviter la pénétration de l'humidité. En ce qui concerne les taches de graisse, il est facile de les éliminer avec de l'acétone.

Il faut prendre en compte que dans le cas de la saleté domestique normale il n'est pas nécessaire d'utiliser des savons abrasifs, de la laine d'acier, de la cire ou une polisseuse pour leur nettoyage et conservation. L'idéal est d'utiliser un nettoyant biodégradable ne laissant aucun résidu et ne nécessitant aucun rinçage après application. Éviter l'exposition directe au soleil pendant des périodes prolongées. Pendant les heures d'ensoleillement maximal, utiliser des volets ou des rideaux pour réduire l'éclairage direct.

VERRE ET MIROIRS

Utiliser un chiffon doux humidifié avec de l'alcool. Éviter d'utiliser des matériaux abrasifs pouvant altérer ou rayer la surface.

ACIER INOXYDABLE

L'acier inoxydable est un acier spécial qui se distingue par sa résistance élevée aux chocs, aux rayures, à la lumière et à la corrosion.

Aucun soin particulier n'est recommandé mais il est important de ne pas utiliser de matériaux abrasifs. Il est recommandé de nettoyer les surfaces avec un chiffon doux et de l'alcool.



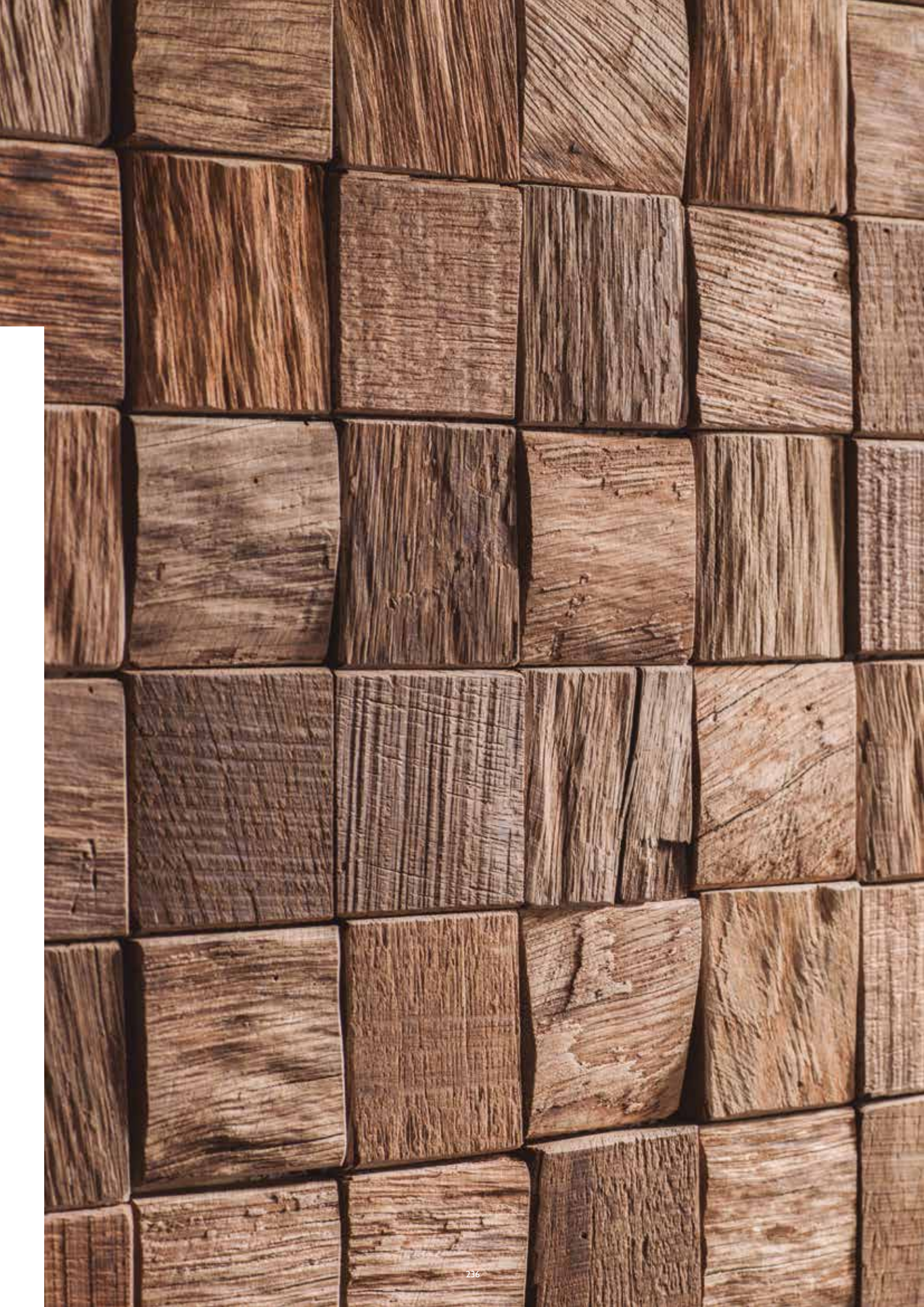

MOSAICS

All L'Antic Colonial mosaics may be subject to shade variations. The colour of the material supplied may differ slightly from that shown. Our website (<http://anticcolonial.com/en/mosaics/>) contains further information in respect of our mosaics, such as installation guides and videos, technical specifications, details on textures or recommendations for use.

Todos los mosaicos de L'Antic Colonial pueden sufrir variaciones de tono. El color del material servido puede no ser exactamente igual al de la muestra. En nuestra página web (<http://anticcolonial.com/mosaicos/>) encontrará información adicional de nuestros mosaicos como guías y vídeos de instalación, fichas técnicas, texturas o recomendaciones de uso.

Toutes les mosaïques de L'Antic Colonial peuvent subir des variations de tonalité. La couleur du matériau fourni peut être légèrement différente de celle de l'échantillon. Sur notre site Internet (<http://anticcolonial.com/fr/mosaïques/>), vous trouverez des informations supplémentaires sur nos mosaïques : manuels et vidéos d'installations, fiches techniques, textures ou recommandations d'utilisation.

SYMBOLS / DESCRIPCIÓN DE ICONOS / DESCRIPTION DES ICONES

Mosaics



Floor Coverings Arctic White Classico / Wall Coverings Gravity Aluminium Hexagon Rose Gold, Arctic White Classico

SYMBOLS / DESCRIPCIÓN DE ICONOS / DESCRIPTION DES ICONES



MESHED

Product manufactured on a mesh that makes installation easier.

ENMALLADO

Producto fabricado sobre una malla que facilita su instalación.

FILET

Produit fabriqué sur un filet qui facilite son installation.



IRREGULAR TEXTURE

Material that stands out for having an asymmetrical surface.

TEXTURA IRREGULAR

Material que destaca por tener una superficie asimétrica.

TEXTURE IRRÉGULIÈRE

Matériau qui se distingue par sa surface asymétrique.



GLOSS

Material with surface with the ability to produce reflections.

BRILLO

Material cuya superficie tiene la capacidad de producir reflejos.

ÉCLAT

Matériau dont la surface est en mesure de produire des reflets.



MATT

Material with a gloss-free surface.

MATE

Material cuya superficie carece de brillo.

MAT

Matériau dont la surface n'est pas brillante.



INDOOR FLOORING

Material suitable for use on indoor floors.

PAVIMENTO INTERIOR

Material apto para su uso en suelos de interior.

REVÊTEMENT DE SOL INTÉRIEUR

Matériau qui convient aux sols d'intérieur.



INDOOR WALL COVERING

Material suitable for use on indoor walls.

REVESTIMIENTO INTERIOR

Material apto para su uso en paredes de interior.

REVÊTEMENT INTÉRIEUR

Matériau qui convient aux murs d'intérieur.



COUNTERTOPS

Material suitable for use on countertops.

ENCIMERAS

Material apto para su uso en encimeras.

PLANS DE TRAVAIL/TOILETTE

Matériau qui convient aux plans de travail/toilette.



OUTDOOR FLOORING

Material suitable for use on outdoor floors.

PAVIMENTO EXTERIOR

Material apto para su uso en suelos de exterior.

REVÊTEMENT DE SOL EXTÉRIEUR

Matériau qui convient aux sols d'extérieur.



OUTDOOR WALL COVERING

Material suitable for use on outdoor walls.

REVESTIMIENTO EXTERIOR

Material apto para su uso en paredes de exterior.

REVÊTEMENT EXTÉRIEUR

Matériau qui convient aux murs d'extérieur.



POOL SURROUNDINGS

Material suitable for use on pool surroundings.

ALREDEDORES PISCINA

Material apto para su uso en zonas inmediaciones de piscinas.

ALENTOURS PISCINES

Matériau qui convient aux abords des piscines.



SHOWER FLOORING

Material suitable for use on shower floors.

PAVIMENTO DUCHAS

Material apto para su uso en suelos de ducha.

REVÊTEMENT DE SOL DOUCHES

Matériau qui convient aux sols de douche.



SHOWER WALL COVERING

Material suitable for use on shower walls.

REVESTIMIENTO DUCHAS

Material apto para su uso en paredes de ducha.

REVÊTEMENT DOUCHES

Matériau qui convient aux murs de douches.



POOL

Material suitable for use on permanently wet areas.

PISCINA

Material apto para su uso en zonas permanentemente húmedas.

PISCINE

Matériau qui convient aux zones toujours humides.



LOW TRAFFIC

Material only suitable for low-traffic floors (private setting).

BAJO TRANSITO

Material indicado sólo para suelos con poco trasiego (ámbito privado).

FAIBLE PASSAGE

Matériau indiqué uniquement pour les revêtements de sols de pièces à faible passage (domaine privé).



MEDIUM TRAFFIC

Material suitable for floors with a considerable use (private setting in high-traffic rooms).

MEDIO TRANSITO

Material indicado para suelos con un uso considerado (ámbito privado en estancias con mucho uso).

PASSAGE MOYEN

Matériau indiqué pour les sols utilisés fréquemment (domaine privé dans des pièces très utilisées).



HIGH TRAFFIC

Material suitable for floors with constant use (public setting).

ALTO TRANSITO

Material indicado para suelos con un uso constante (ámbito público).

PASSAGE ÉLEVÉ

Matériau indiqué pour les sols utilisés constamment (domaine public).



Wall Coverings World Hexagon Text. Grey, Ibiza Snow



STONE MOSAICS



World
Elite
Ancient
Lines
Essential
Outlines
Aichi
Moon
Paradise
Skyline
Luxury
Magma

WORLD

Mosaics

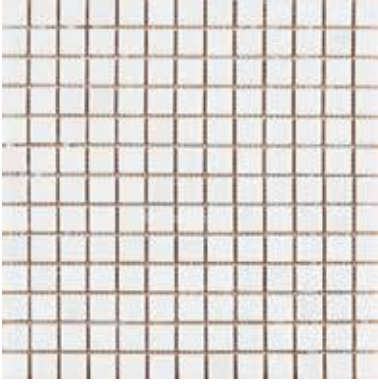

World Blanco Almeria
2x2 cm - 3/4"x3/4"



MARBLE / MÁRMOL / MARBRE

Butech: Colorstuk Rapid Blanco

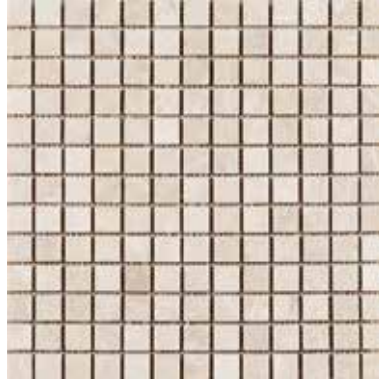

World Crema Italia
2x2cm - 3/4"x3/4"



MARBLE / MÁRMOL / MARBRE

Butech: Colorstuk Rapid Marfil

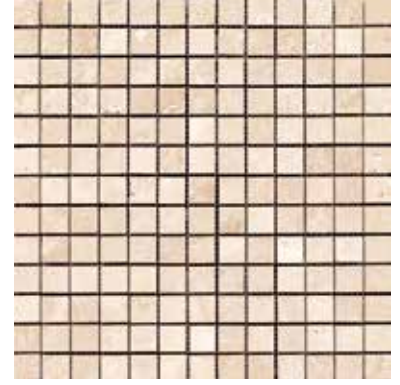

World Beige
2x2cm - 3/4"x3/4"



TRAVERTINE / TRAVERTINO / TRAVERTIN

Butech: Colorstuk Rapid Beige



World Random Shannan



QUARTZITE / CUARCITA / QUARTZITES

Butech: Colorstuk Rapid Manhattan



World Random Nepal



SLATE / PIZARRA / ARDOISE

Butech: Colorstuk Rapid Manhattan



World Hexagon Text. Grey



LIMESTONE / CALIZA / PIERRE CALCAIRE

Butech: Colorstuk Rapid Cemento

Description	Format	Codes	Group	Pcs	m2	Kg
World Blanco Almeria	29x29x1 cm	100000559	G-116	10 x Cj	0,84 x Cj	18,84 x Cj
	11 7/16"x11 7/16"x3/8"	L119401501		360 x Pal	30,28 x Pal	678,24 x Pal
World Crema Italia	29x29x1 cm	100000560	G-116	10 x Cj	0,84 x Cj	15,33 x Cj
	11 3/8"x11 3/8"x3/8"	L119402501		360 x Pal	30,28 x Pal	551,88 x Pal
World Beige	29x29x1 cm	100000561	G-116	10 x Cj	0,73 x Cj	19,78 x Cj
	11 3/8"x11 3/8"x3/8"	L119404501		360 x Pal	26,37 x Pal	712,08 x Pal
World Random Shannan	30x30,5x1-1,2 cm	100153596	G-110	10 x Cj	0,91 x Cj	25 x Cj
	11 3/4"x12"x3/8"-1/2"	L241710991		540 x Pal	49,41 x Pal	1350 x Pal
World Random Nepal	30x30,5x1-1,2 cm	100153595	G-110	10 x Cj	0,91 x Cj	18 x Cj
	11 3/4"x12"x3/8"-1/2"	L241711001		540 x Pal	49,41 x Pal	972 x Pal
World Hexagon Text. Grey	30,5x26,5x0,8 cm	100190437	G-126	10 x Cj	0,80 x Cj	17,60 x Cj
	12"x10 3/8"x3/8"	L241714531		480 x Pal	38,79 x Pal	844,80 x Pal

WORLD



World Amsterdam Brick Grey



LIMESTONE / CALIZA / PIERRE CALCAIRE

Butech: Colorstuk Rapid Gris



World Amsterdam Brick Beige



LIMESTONE / CALIZA / PIERRE CALCAIRE

Butech: Colorstuk Rapid Beige



Wall Coverings World Amsterdam Brick Beige

Description	Format	Codes	Group	Pcs	m2	Kg
World Amsterdam Brick Grey	30x29.5x1 cm	I00173144	G-133	10 x Cj	0,89 x Cj	19,82 x Cj
	11 3/4"x11 5/8"x3/8"	L241713861		360 x Pal	31,86 x Pal	713,52 x Pal
World Amsterdam Brick Beige	30x29.5x1 cm	I00173161	G-133	10 x Cj	0,89 x Cj	19,82 x Cj
	11 3/4"x11 5/8"x3/8"	L241713851		360 x Pal	31,86 x Pal	713,52 x Pal

ELITE

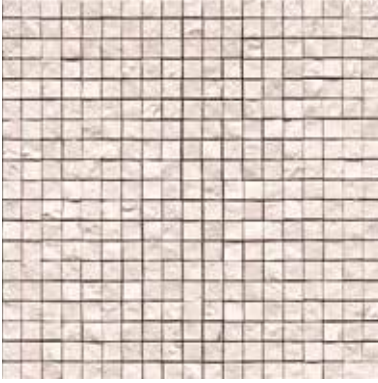

Elite Even Crema Grecia
1,5x1,5 cm - 5/8"x5/8"



MARBLE / MÁRMOL / MARBRE

No supported grouting / No admite rejuntado /
Ne peut pas être jointoyé.



Elite Even Burma
1,5x1,5 cm - 5/8"x5/8"



QUARTZITE / CUARCITA / QUARTZITES

No supported grouting / No admite rejuntado /
Ne peut pas être jointoyé.

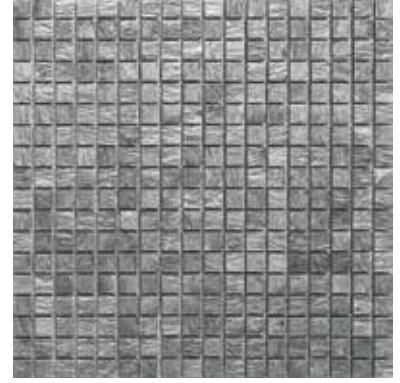

Elite Bhutan Silver
1,5x1,5cm - 5/8"x5/8"



ENAMELED SLATE / PIZARRA ESMALTADA /
ARDOISE ÉMAILLÉ

Butech: Colorstuk Rapid Gris



Elite Bhutan Copper
1,5x1,5cm - 5/8"x5/8"



ENAMELED SLATE / PIZARRA ESMALTADA /
ARDOISE ÉMAILLÉ

Butech: Colorstuk Rapid Beige



Elite Lava Stone Silver
1,4x1,4cm - 1/2"x1/2"



BASALT / BASALTO / BASALTE
SCREEN PRINTED / SERIGRAFÍA / ÉCRAN

No supported grouting / No admite rejuntado /
Ne peut pas être jointoyé.



Elite Lava Stone Mix Gold Silver
1,4x1,4cm - 1/2"x1/2"



BASALT / BASALTO / BASALTE
SCREEN PRINTED / SERIGRAFÍA / ÉCRAN

No supported grouting / No admite rejuntado /
Ne peut pas être jointoyé.

Description	Format	Codes	Group	Pcs	m2	Kg
Elite Even Crema Grecia (1,5)	30x30x1 cm	100153006	G-146	10 x Cj	0,90 x Cj	15,44 x Cj
	11 3/4"x11 3/4"x3/8"	L241710611		420 x Pal	37,80 x Pal	648,48 x Pal
Elite Even Burma (1,5)	30x30x1 cm	100057244	G-131	10 x Cj	0,90 x Cj	16,14 x Cj
	11 3/4"x11 3/4"x3/8"	L108003031		420 x Pal	37,80 x Pal	678 x Pal
Elite Bhutan Silver (1,5)	30x30x1 cm	100080871	G-114	11 x Cj	0,99 x Cj	17,22 x Cj
	11 3/4"x11 3/4"x3/8"	L108008561		594 x Pal	53,46 x Pal	930 x Pal
Elite Bhutan Copper (1,5)	30x30x1 cm	100080870	G-114	11 x Cj	0,99 x Cj	17,22 x Cj
	11 3/4"x11 3/4"x3/8"	L108008551		594 x Pal	53,46 x Pal	930 x Pal
Elite Lava Stone Silver	30x30x1,5 cm	100161507	G-146	10 x Cj	0,9 x Cj	13,45 x Cj
	11 3/4"x11 3/4"x5/8"	L241712861		600 x Pal	54 x Pal	807 x Pal
Elite Lava Stone Mix Gold Silver	30x30x1,5 cm	100161534	G-146	10 x Cj	0,9 x Cj	13,45 x Cj
	11 3/4"x11 3/4"x5/8"	L241712841		600 x Pal	54 x Pal	807 x Pal

ELITE



Elite Lava Stone Mix Gold White
1,4x1,4cm - 1/2"x1/2"



BASALT / BASALTO / BASALTE
SCREEN PRINTED / SERIGRAFÍA / ÉCRAN

No supported grouting / No admite rejuntado /
Ne peut pas être jointoyé.



Elite Lava Stone Brick Silver



BASALT / BASALTO / BASALTE
SCREEN PRINTED / SERIGRAFÍA / ÉCRAN

No supported grouting / No admite rejuntado /
Ne peut pas être jointoyé.

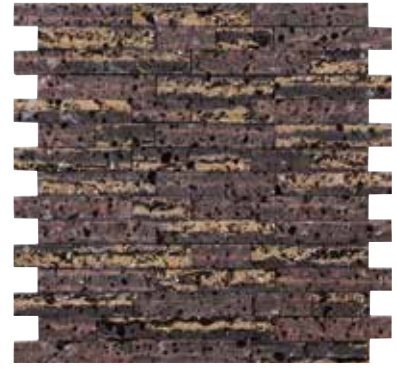

Elite Lava Stone Brick Gold



BASALT / BASALTO / BASALTE
SCREEN PRINTED / SERIGRAFÍA / ÉCRAN

No supported grouting / No admite rejuntado /
Ne peut pas être jointoyé.



Elite Lava Stone Gold
1,4x1,4cm - 1/2"x1/2"



BASALT / BASALTO / BASALTE
SCREEN PRINTED / SERIGRAFÍA / ÉCRAN

No supported grouting / No admite rejuntado /
Ne peut pas être jointoyé.



Wall Coverings Elite Lava Stone Brick Gold

Description	Format	Codes	Group	Pcs	m2	Kg
Elite Lava Stone Mix Gold White	30,1x30,1x1,6cm	I00172973	G-146	5 x Cj	0,49 x Cj	6,73 x Cj
	11 7/8"x11 7/8"x5/8"	L241713811		240 x Pal	23,27 x Pal	322,80 x Pal
Elite Lava Stone Brick Silver	30,3x32x1,4cm	I00172972	G-146	5 x Cj	0,49 x Cj	6,73 x Cj
	11 7/8"x12 5/8"x1/2"	L241713801		240 x Pal	23,27 x Pal	322,80 x Pal
Elite Lava Stone Brick Gold	30,3x32x1,4cm	I00172981	G-146	5 x Cj	0,49 x Cj	6,73 x Cj
	11 7/8"x12 5/8"x1/2"	L241713821		240 x Pal	23,27 x Pal	322,80 x Pal
Elite Lava Stone Gold	30x30x1,2cm	I00190440	G-146	5 x Cj	0,45 x Cj	13,97 x Cj
	11 3/4"x11 3/4"x1/2"	L241714541		240 x Pal	21,60 x Pal	670,80 x Pal

ELITE



Elite Capuccino Texture - Pul.
1,5x1,5cm - 5/8"x5/8"



MARBLE / MÁRMOL / MARBRE

Butech: Colorstuk Rapid Beige



Elite Brick Creams
2,5x4,8cm - 1"x1 7/8"



MARBLE / MÁRMOL / MARBRE

No supported grouting / No admite rejuntado /
Ne peut pas être jointoyé.



Elite Brick Silver Wood
2,5x4,8cm - 1"x1 7/8"



TRAVERTINE / TRAVERTINO / TRAVERTIN

No supported grouting / No admite rejuntado /
Ne peut pas être jointoyé.



Elite Brick Whites
2,5x4,8cm - 1"x1 7/8"



MARBLE / MÁRMOL / MARBRE

No supported grouting / No admite rejuntado /
Ne peut pas être jointoyé.



Elite Brick Ariana
2,5x4,8cm - 1x1 7/8"



MARBLE / MÁRMOL / MARBRE

No supported grouting / No admite rejuntado /
Ne peut pas être jointoyé.

Description	Format	Codes	Group	Pcs	m2	Kg
Elite Capuccino Texture-Pul. (1,5)	30x30x1 cm	100086096	G-137	10 x Cj	0,90 x Cj	18,61 x Cj
	11 3/4"x11 3/4"x3/8"	L108010101		360 x Pal	32,40 x Pal	670 x Pal
Elite Brick Creams (2,5X4,8)	29x31,5x1,5 cm	100099430	G-113	7 x Cj	0,64 x Cj	16,30 x Cj
	11 3/8"x12 3/8"x5/8"	L119487381		252 x Pal	23,02 x Pal	586,91 x Pal
Elite Brick Silver Wood (2,6X4,8)	30x30x0,8 cm	100119813	G-117	7 x Cj	0,63 x Cj	13,40 x Cj
	11 3/4"x11 3/4"x3/8"	L241709051		336 x Pal	30,24 x Pal	643,10 x Pal
Elite Brick Whites (2,5X4,8)	29x31,5x1,5 cm	100099431	G-117	7 x Cj	0,64 x Cj	16,30 x Cj
	11 3/8"x12 3/8"x5/8"	L119487391		252 x Pal	23,02 x Pal	586,91 x Pal
Elite Brick Ariana (2,5x4,8)	29x31,5x1,5 cm	100100734	G-111	7 x Cj	0,64 x Cj	17,75 x Cj
	11 3/8"x12 3/8"x5/8"	L119487421		252 x Pal	23,02 x Pal	639,07 x Pal

ANCIENT



Ancient Bath
2,3x2,3cm - 7/8"x7/8"



MARBLE / MÁRMOL / MARBRE

Butech: Colorstuk Rapid Beige



Ancient Earth
2,3x2,3cm - 7/8"x7/8"



MARBLE / MÁRMOL / MARBRE

Butech: Colorstuk Rapid Beige



Wall Coverings Ancient Bath

Description	Format	Codes	Group	Pcs	m2	Kg
Ancient Bath (2,3)	30,5x30,5x1 cm 12"x12"x3/8"	I00113694 L241707091	G-156	10 x Cj 420 x Pal	0,93 x Cj 39,07 x Pal	20,90 x Cj 842,94 x Pal
Ancient Earth (2,3)	30,5x30,5x1 cm 12"x12"x3/8"	I00113696 L241707001	G-156	10 x Cj 420 x Pal	0,93 x Cj 39,07 x Pal	21,32 x Cj 895,44 x Pal

LINES



Lines Cambric Persian White Pulido



MARBLE / MÁRMOL / MARBRE

Butech: Colorstuk 0-4 Blanco



Lines Cambric Persian White Classico



MARBLE / MÁRMOL / MARBRE

Butech: Colorstuk 0-4 Blanco



Lines Cambric Silver Wood Pulido



TRAVERTINE / TRAVERTINO / TRAVERTIN

Butech: Colorstuk 0-4 Gris



Lines Mini Cambric Persian White Pulido



MARBLE / MÁRMOL / MARBRE

Butech: Colorstuk 0-4 Blanco



Lines Mini Cambric Persian White Classico



MARBLE / MÁRMOL / MARBRE

Butech: Colorstuk 0-4 Blanco

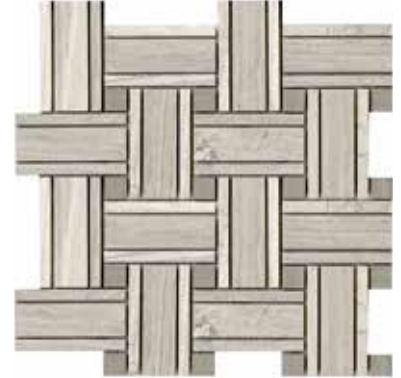

Lines Silver Wood Grey



TRAVERTINE / TRAVERTINO / TRAVERTIN

Butech: Colorstuk 0-4 Blanco

Description	Format	Codes	Group	Pcs	m2	Kg
Lines Cambric Persian White Pul	26.5x32.5x1 cm 10 3/8"x12 3/4"x3/8"	100173890 L241713951	G-133	10 x Cj 480 x Pal	1,11 x Cj 53,29 x Pal	14,69 xCj 705,12 x Pal
Lines Cambric Persian White Clas	26.5x32.5x1 cm 10 3/8"x12 3/4"x3/8"	100173879 L241713941	G-133	10 x Cj 480 x Pal	1,11 x Cj 53,29 x Pal	14,69 xCj 705,12 x Pal
Lines Cambric Silver Wood Pul	26.5x32.5x1 cm 10 3/8"x12 3/4"x3/8"	100173869 L241713961	G-133	10 x Cj 480 x Pal	1,11 x Cj 53,29 x Pal	14,69 xCj 705,12 x Pal
Lines Minicambric Persian White Pul	25.5x28x1 cm 10"x11"x3/8"	100161535 L241712821	G-133	10 x Cj 360 x Pal	0,71 x Cj 25,70 x Pal	11,38 x Cj 409,68 x Pal
Lines Minicambric Persian White Clas	25.5x28x1 cm 10"x11"x3/8"	100161517 L241712831	G-133	10 x Cj 360 x Pal	0,71 x Cj 25,70 x Pal	11,38 x Cj 409,68 x Pal
Lines Silver Wood Grey	31x31x1 cm 12 1/4"x12 1/4"x3/8"	100110504 L101200001	G-136	10 x Cj 360 x Pal	0,96 x Cj 34,56 x Pal	23,10 x Cj 831,60 x Pal

LINES



Lines Cambric Silver Wood Classico



TRAVERTINE / TRAVERTINO / TRAVERTIN

Butech: Colorstuk 0-4 Gris



Lines Mini Cambric Silver Wood Pulido



TRAVERTINE / TRAVERTINO / TRAVERTIN

Butech: Colorstuk 0-4 Gris



Lines Mini Cambric Silver Wood Classico



TRAVERTINE / TRAVERTINO / TRAVERTIN

Butech: Colorstuk 0-4 Gris



Lines Safary Brown



TRAVERTINE / TRAVERTINO / TRAVERTIN

Butech: Colorstuk 0-4 Cemento

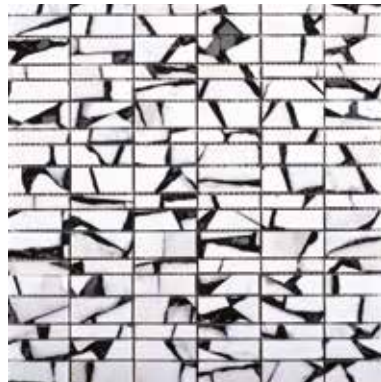

Lines Safary White



MARBLE / MÁRMOL / MARBRE

Butech: Colorstuk 0-4 Blanco

Description	Format	Codes	Group	Pcs	m2	Kg
Lines Cambric Silver Wood Clas	26,5x32,5x1 cm 10 3/8"x12 3/4"x3/8"	I00173881	G-133	10 x Cj	1,11 x Cj	14,69 x Cj
		L241713931		480 x Pal	53,29 x Pal	705,12 x Pal
Lines Minicambric Silver Wood Pul	25,5x28x1 cm 10"x11"x3/8"	I00161519	G-133	10 x Cj	0,71 x Cj	11,38 x Cj
		L241712811		360 x Pal	25,70 x Pal	409,68 x Pal
Lines Minicambric Silver Wood Clas	25,5x28x1 cm 10"x11"x3/8"	I00161518	G-133	10 x Cj	0,71 x Cj	11,38 x Cj
		L241712851		360 x Pal	25,70 x Pal	409,68 x Pal
Lines Safary White	30,4x29,8x1 cm 12"x11 3/4"x3/8"	I00103960	G-151	10 x Cj	0,91 x Cj	22,05 x Cj
		L153801151		360 x Pal	32,61 x Pal	793,80 x Pal
Lines Safary Brown	30,4x29,8x1 cm 12"x11 3/4"x3/8"	I00103959	G-151	10 x Cj	0,91 x Cj	22,05 x Cj
		L153801161		360 x Pal	32,61 x Pal	793,80 x Pal

ESSENTIAL



Essential Chess Thassos



MARBLE / MÁRMOL / MARBRE

Butech: Colorstuk Rapid Blanco



Essential Basket Thassos



MARBLE / MÁRMOL / MARBRE

Butech: Colorstuk Rapid Blanco



Essential Flag Thassos



MARBLE / MÁRMOL / MARBRE

Butech: Colorstuk Rapid Blanco



Essential Chess Silver Wood



TRAVERTINE / TRAVERTINO / TRAVERTIN

Butech: Colorstuk Rapid Gris



Essential Basket Silver Wood



TRAVERTINE / TRAVERTINO / TRAVERTIN

Butech: Colorstuk Rapid Gris



Essential Stripes Silver Wood



TRAVERTINE / TRAVERTINO / TRAVERTIN

Butech: Colorstuk Rapid Gris

Description	Format	Codes	Group	Pcs	m2	Kg
Essential Chess Thassos	30,6x30,6x1 cm	100115762	G-150	10 x Cj	0,93 x Cj	22,77 x Cj
	12"x12"x3/8"	L241708001		360 x Pal	33,69 x Pal	819,72 x Pal
Essential Basket Thassos	28,7x28,7x1 cm	100115760	G-146	10 x Cj	0,82 x Cj	20,07 x Cj
	11 1/4"x11 1/4"x3/8"	L241708071		360 x Pal	29,63 x Pal	722,52 x Pal
Essential Flag Thassos	30,2x32,2x1 cm	100115764	G-156	10 x Cj	0,97 x Cj	23,70 x Cj
	11 7/8"x12 5/8"x3/8"	L241708091		360 x Pal	34,99 x Pal	853,20 x Pal
Essential Chess Silver Wood	30,6x30,6x1 cm	100115761	G-146	10 x Cj	0,93 x Cj	22,77 x Cj
	12"x12"x3/8"	L241708101		360 x Pal	33,69 x Pal	819,72 x Pal
Essential Basket Silver Wood	28,7x28,7x1 cm	100115759	G-146	10 x Cj	0,82 x Cj	20,07 x Cj
	11 1/4"x11 1/4"x3/8"	L241708061		360 x Pal	29,63 x Pal	722,52 x Pal
Essential Stripes Silver Wood	30,5x30,5x1 cm	100115765	G-150	10 x Cj	0,93 x Cj	22,66 x Cj
	12"x12"x3/8"	L241708041		360 x Pal	33,48 x Pal	815,76 x Pal

ESSENTIAL



Essential Hexagon Persian White



MARBLE / MÁRMOL / MARBRE

Butech: Colorstuk Rapid Blanco

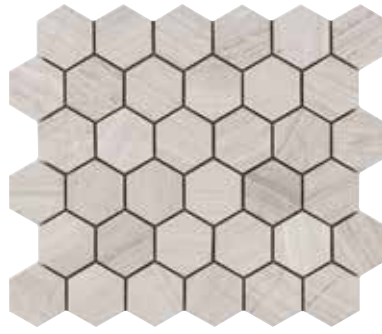

Essential Hexagon Silver Wood



TRAVERTINE / TRAVERTINO / TRAVERTIN

Butech: Colorstuk Rapid Gris

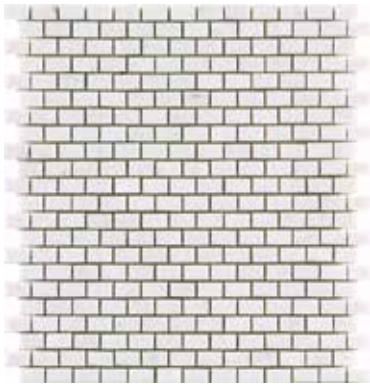

Essential Mini Brick Persian White

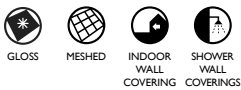

MARBLE / MÁRMOL / MARBRE

Butech: Colorstuk Rapid Blanco



Essential Mini Brick Silver Wood



TRAVERTINE / TRAVERTINO / TRAVERTIN

Butech: Colorstuk Rapid Gris

Description	Format	Codes	Group	Pcs	m2	Kg
Essential Hexagon Persian White	25,8x29,8x1 cm 10 1/8"x11 3/4"x3/8"	I00188562	G-135	10 x Cj	0,77 x Cj	18,40 x Cj
		L241714511		360 x Pal	27,68 x Pal	662,40 x Pal
Essential Hexagon Silver Wood	25,8x29,8x1 cm 10 1/8"x11 3/4"x3/8"	I00189456	G-135	10 x Cj	0,77 x Cj	16,56 x Cj
		L241714521		360 x Pal	27,68 x Pal	596,16 x Pal
Essential Mini Brick Persian White	28x30x1 cm 11"x11 3/4"x3/8"	I00179706	G-130	10 x Cj	0,84 x Cj	17,01 x Cj
		L241714391		360 x Pal	30,24 x Pal	612,36 x Pal
Essential Mini Brick Silver Wood	28x30x1 cm 11"x11 3/4"x3/8"	I00179704	G-140	10 x Cj	0,84 x Cj	17,01 x Cj
		L241714381		360 x Pal	30,24 x Pal	612,36 x Pal

OUTLINES



Outlines Mini Strip Shannan



QUARTZITE / CUARCITA / QUARTZITE

Butech: Colorstuk Rapid Marfil



Outlines Mini Strip Canyon



QUARTZITE / CUARCITA / QUARTZITE

Butech: Colorstuk Rapid Blanco



Wall Coverings Outlines Mini Strip Canyon

Description	Format	Codes	Group	Pcs	m2	Kg
Outlines Mini Strip Shannan	29,9x22,7x1 cm	I00062966	G-119	10 x Cj	0,68 x Cj	15,53 x Cj
	11 3/4"x8 7/8"x3/8"	L108005221		360 x Pal	24,48 x Pal	559,08 x Pal
Outlines Mini Strip Canyon	29,9x22,7x1 cm	I00103947	G-136	10 x Cj	0,68 x Cj	16,56 x Cj
	11 3/4"x8 7/8"x3/8"	L108017171		360 x Pal	24,52 x Pal	596,16 x Pal

AICHI



Aichi Greys
0,5x10cm - 1/4"x3 7/8"



MARBLE / MÁRMOL / MARBRE

Butech: Colorstuk Rapid Gris



Aichi Browns
0,5x10cm - 1/4"x3 7/8"



MARBLE / MÁRMOL / MARBRE

Butech: Colorstuk Rapid Beige



Aichi Mix Wood
0,5x10cm - 1/4"x3 7/8"



TRAVERTINE / TRAVERTINO / TRAVERTIN

Butech: Colorstuk Rapid Gris



Wall Coverings Aichi Mix Wood

Description	Format	Codes	Group	Pcs	m2	Kg
Aichi Greys (0,5X10)	29,8x30,5x1 cm	100057249	G-138	5 x Cj	0,45 x Cj	9,48 x Cj
	11 3/4"x12"x3/8"	L108003011		360 x Pal	32,40 x Pal	708,12 x Pal
Aichi Browns (0,5X10)	29,8x30,5x1 cm	10001555	G-138	5 x Cj	0,45 x Cj	10,21 x Cj
	11 3/4"x12"x3/8"	L150901001		360 x Pal	32,40 x Pal	735 x Pal
Aichi Mix Wood (0,5X10)	29,8x29,8x1 cm	100115754	G-138	5 x Cj	0,45 x Cj	10,82 x Cj
	11 3/4"x11 3/4"x3/8"	L241708021		360 x Pal	32,72 x Pal	778,68 x Pal

MOON

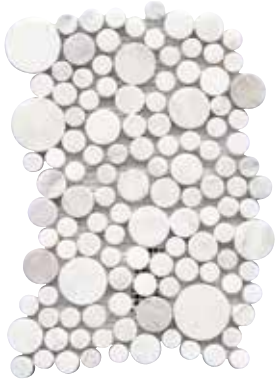

Moon Marmara



MARBLE / MÁRMOL / MARBRE

Butech: Colorstuk Rapid Blanco



Moon Silver Wood



TRAVERTINE / TRAVERTINO / TRAVERTIN

Butech: Colorstuk Rapid Blanco / Gris

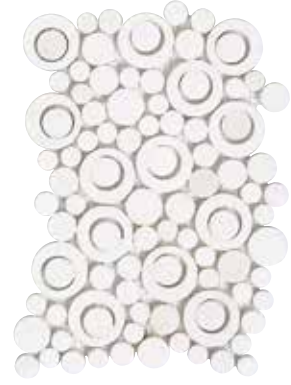

Moon Saturn Blanco



MARBLE / MÁRMOL / MARBRE

Butech: Colorstuk Rapid Blanco

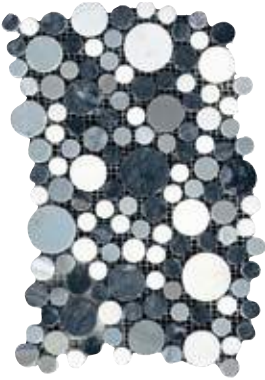

Moon Mix Greys



MARBLE / MÁRMOL / MARBRE

Butech: Colorstuk Rapid Blanco / Gris



Moon Mix Browns



MARBLE / MÁRMOL / MARBRE

Butech: Colorstuk Rapid Bahama

Description	Format	Codes	Group	Pcs	m2	Kg
Moon Mármara	19x29x1 cm 7 7/8"x7 7/8"x3/8"	I00153030	G-130	10 x Cj	0,55 x Cj	11,65 x Cj
		L241710631		680 x Pal	37,46 x Pal	792,20 x Pal
Moon Silver Wood	19x29x1 cm 7 7/8"x7 7/8"x3/8"	I00115838	G-117	12 x Cj	0,66 x Cj	11,54 x Cj
		L241708141		720 x Pal	39,67 x Pal	692,64 x Pal
Moon Saturn Blanco	19x29x1 cm 7 7/8"x7 7/8"x3/8"	I00153031	G-142	10 x Cj	0,55 x Cj	20 x Cj
		L241710621		680 x Pal	37,46 x Pal	1.360 x Pal
Moon Mix Greys	19x29x1 cm 7 7/8"x7 7/8"x3/8"	I00079201	G-135	5 x Cj	0,28 x Cj	5,75 x Cj
		L108007921		600 x Pal	33,06 x Pal	690 x Pal
Moon Mix Browns	19x29x1 cm 7 7/8"x7 7/8"x3/8"	I00079200	G-119	5 x Cj	0,28 x Cj	5,75 x Cj
		L108007911		540 x Pal	29,75 x Pal	621 x Pal

PARADISE



Paradise Baia Stone Negro



BASALT / BASALTO / BASALTE

Butech: Colorstuk Rapid Antracita / Cemento

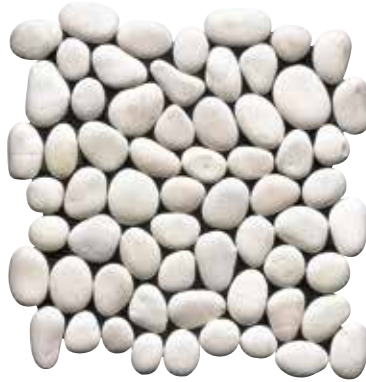

Paradise Baia Stone Blanco



MARBLE / MÁRMOL / MARBRE

Butech: Colorstuk Rapid Blanco / Gris

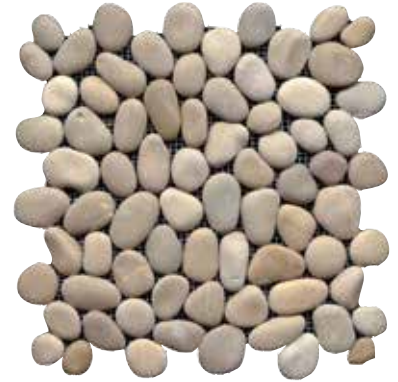

Paradise Baia Stone Cremas



MARBLE / MÁRMOL / MARBRE

Butech: Colorstuk Rapid Beige



Paradise Lake Stone Negro



BASALT / BASALTO / BASALTE

Butech: Colorstuk Rapid Antracita / Cemento



Paradise Lake Stone Blanco



MARBLE / MÁRMOL / MARBRE

Butech: Colorstuk Rapid Marfil



Paradise Lake Stone Cremas



MARBLE / MÁRMOL / MARBRE

Butech: Colorstuk Rapid Manhattan

Description	Format	Codes	Group	Pcs	m2	Kg
Paradise Baia Stone Negro	30x30x1 cm	100001572	G-110	10 x Cj	0,90 x Cj	23,80 x Cj
	11 3/4"x11 3/4"x3/8"	L152901011		360 x Pal	32,40 x Pal	856,80 x Pal
Paradise Baia Stone Blanco	30x30x1 cm	100001571	G-110	10 x Cj	0,90 x Cj	23,80 x Cj
	11 3/4"x11 3/4"x3/8"	L152901001		360 x Pal	32,40 x Pal	856,80 x Pal
Paradise Baia Stone Cremas	30x30x1 cm	100068033	G-110	10 x Cj	0,90 x Cj	23,80 x Cj
	11 3/4"x11 3/4"x3/8"	L108006581		360 x Pal	32,40 x Pal	856,80 x Pal
Paradise Lake Stone Negro	30x30x1 cm	100062502	G-110	9 x Cj	0,81 x Cj	17,05 x Cj
	11 3/4"x11 3/4"x3/8"	L159001521		486 x Pal	43,74 x Pal	920,48 x Pal
Paradise Lake Stone Blanco	30x30x1 cm	100062501	G-110	9 x Cj	0,81 x Cj	17,05 x Cj
	11 3/4"x11 3/4"x3/8"	L159001531		486 x Pal	43,74 x Pal	920,48 x Pal
Paradise Lake Stone Cremas	30x30x1 cm	100082709	G-110	9 x Cj	0,81 x Cj	16,47 x Cj
	11 3/4"x11 3/4"x3/8"	L108008991		486 x Pal	43,74 x Pal	889,38 x Pal

2017

2017

PARADISE



Paradise Minibroken Edge Negro



BASALT / BASALTO / BASALTE

Butech: Colorstuk Rapid Cemento



Paradise Minibroken Edge Blanco



MARBLE / MÁRMOL / MARBRE

Butech: Colorstuk Rapid Bahama



Paradise Round Stone Negro



BASALT / BASALTO / BASALTE

Butech: Colorstuk Rapid Blanco

Mosaics



Paradise Round Stone Blanco



MARBLE / MÁRMOL / MARBRE

Butech: Colorstuk Rapid Gris



Floor Coverings Paradise Baia Stone Blanco

Description	Format	Codes	Group	Pcs	m2	Kg
Paradise Minibroken Edge Negro	32x32x1 cm 12 5/8"x12 5/8"x3/8"	100068135	G-110	9 x Cj	54 x Cj	20,96 x Cj
		L108006681		0,92 x Pal	49,77 x Pal	1131,89 x Pal
Paradise Minibroken Edge Blanco	32x32x1 cm 12 5/8"x12 5/8"x3/8"	100068134	G-110	9 x Cj	54 x Cj	20,96 x Cj
		L108006671		0,92 x Pal	49,77 x Pal	1131,89 x Pal
Paradise Round Stone Negro	31,5x31,5x1 cm 12 3/8"x12 3/8"x3/8"	100068032	G-110	9 x Cj	54 x Cj	21,15 x Cj
		L154201511		0,89 x Pal	48,22 x Pal	1142,10 x Pal
Paradise Round Stone Blanco	31,5x31,5x1 cm 12 3/8"x12 3/8"x3/8"	100068031	G-110	9 x Cj	54 x Cj	21,15 x Cj
		L154201521		0,89 x Pal	48,22 x Pal	1142,10 x Pal

PARADISE



Paradise Arrow Negro



BASALT / BASALTO / BASALTE

Butech: Colorstuk Rapid Cemento



Paradise Arrow Blanco



MARBLE / MÁRMOL / MARBRE

Butech: Colorstuk Rapid Blanco



Paradise Arrow Gris



BASALT / BASALTO / BASALTE

Butech: Colorstuk Rapid Gris



Paradise Tinybroken Edge Negro



BASALT / BASALTO / BASALTE

Butech: Colorstuk Rapid Cemento

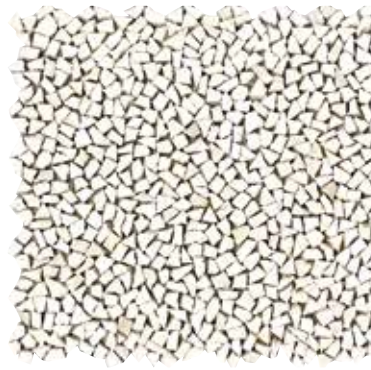

Paradise Tinybroken Edge Blanco



MARBLE / MÁRMOL / MARBRE

Butech: Colorstuk Rapid Blanco



Paradise Tinybroken Edge Gris



BASALT / BASALTO / BASALTE

Butech: Colorstuk Rapid Gris

Description	Format	Codes	Group	Pcs	m2	Kg
Paradise Arrow Negro	29,2x27,2x0,8 cm	100112566	G-110	10 x Cj	0,79 x Cj	15,16 x Cj
	11 1/2"x10 3/4"x3/8"	L241702581		360 x Pal	28,44 x Pal	545,76 x Pal
Paradise Arrow Blanco	29,2x27,2x0,8 cm	100112564	G-110	10 x Cj	0,79 x Cj	14,69 x Cj
	11 1/2"x10 3/4"x3/8"	L241702541		360 x Pal	28,44 x Pal	528,84 x Pal
Paradise Arrow Gris	29,2x27,2x0,8 cm	100112565	G-110	10 x Cj	0,79 x Cj	15,99 x Cj
	11 1/2"x10 3/4"x3/8"	L241702551		360 x Pal	28,44 x Pal	575,64 x Pal
Paradise Tinybroken Edge Negro	31x31x0,8 cm	100112570	G-110	9 x Cj	0,87 x Cj	6,30 x Cj
	12 1/4"x12 1/4"x3/8"	L241702571		324 x Pal	31,32 x Pal	586,80 x Pal
Paradise Tinybroken Edge Blanco	31x31x0,8 cm	100112568	G-110	9 x Cj	0,87 x Cj	16,25 x Cj
	12 1/4"x12 1/4"x3/8"	L241702561		324 x Pal	31,32 x Pal	585 x Pal
Paradise Tinybroken Edge Gris	31x31x0,8 cm	100112569	G-110	9 x Cj	0,87 x Cj	16,58 x Cj
	12 1/4"x12 1/4"x3/8"	L241702591		324 x Pal	31,32 x Pal	596,88 x Pal



PARADISE



Paradise Tinybroken Cubes Negro



BASALT / BASALTO / BASALTE

Butech: Colorstuk Rapid Cemento

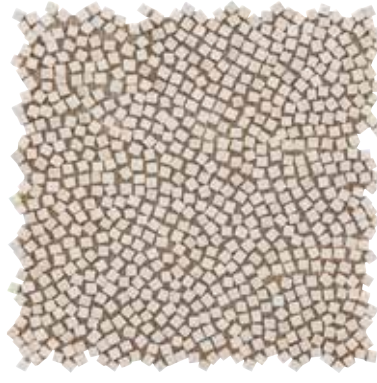

Paradise Tinybroken Cubes Blanco



MARBLE / MÁRMOL / MARBRE

Butech: Colorstuk Rapid Blanco



Wall Coverings Paradise Tinybroken Edge Gris

Description	Format	Codes	Group	Pcs	m2	Kg
Paradise Tinybroken Cubes Negro	31,5x31,5x0,9 cm	I00169406	G-116	9 x Cj	0,89 x Cj	16,25 x Cj
	12 3/8" x 12 3/8" x 3/8"	L241713531		324 x Pal	32,15 x Pal	585,14 x Pal
Paradise Tinybroken Cubes Blanco	31,5x31,5x0,9 cm	I00169395	G-116	9 x Cj	0,89 x Cj	16,25 x Cj
	12 3/8" x 12 3/8" x 3/8"	L241713511		324 x Pal	32,15 x Pal	585,14 x Pal

SKYLINE



Skyline Trial Delhi
4,8x4,8 - 1 7/8" x 1 7/8"

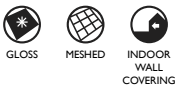

SLATE / PIZARRA / ARDOISE

No supported grouting / No admite rejuntado /
Ne peut pas être jointoyé.



Skyline Linear Broken Dark



SLATE / PIZARRA / ARDOISE

No supported grouting / No admite rejuntado /
Ne peut pas être jointoyé.



Skyline Mix Broken Dark



SLATE / PIZARRA / ARDOISE
GRANITE / GRANITO / GRANITE

No supported grouting / No admite rejuntado /
Ne peut pas être jointoyé.



Skyline City Beige



TRAVERTINE / TRAVERTINO / TRAVERTIN

No supported grouting / No admite rejuntado /
Ne peut pas être jointoyé.



Skyline City Earth



SLATE / PIZARRA / ARDOISE

No supported grouting / No admite rejuntado /
Ne peut pas être jointoyé.



Skyline City Volcano



SLATE / PIZARRA / ARDOISE

No supported grouting / No admite rejuntado /
Ne peut pas être jointoyé.

Description	Format	Codes	Group	Pcs	m2	Kg
Skyline Trial Delhi (4,8)	29x29x1 cm	100090618	G-114	9 x Cj	0,76 x Cj	21,43 x Cj
	11 3/8" x 11 3/8" x 3/8"	L119487071		31,79 x Pal	900,02 x Pal	
Skyline Linear Broken Dark	14,4x29,4x1,3 cm	100111415	G-135	8 x Cj	0,34 x Cj	14,24 x Cj
	5 5/8" x 11 5/8" x 1/2"	L241702451		2,88 x Pal	12,19 x Pal	512,64 x Pal
Skyline Mix Broken Dark	14,5x29,3x1,3 cm	100135766	G-142	8 x Cj	0,33 x Cj	9,97 x Cj
	5 3/4" x 11 1/2" x 1/2"	L241709541		2,88 x Pal	11,73 x Pal	358,85 x Pal
Skyline City Beige	27x27x1-1,5 cm	100146048	G-140	6 x Cj	0,44 x Cj	12,36 x Cj
	10 5/8" x 10 5/8" x 3/8"-5/8"	L241709991		2,16 x Pal	15,74 x Pal	444,96 x Pal
Skyline City Earth	27x27x0,6-3 cm	100146049	G-140	5 x Cj	0,36 x Cj	14,90 x Cj
	10 5/8" x 10 5/8" x 1/4"-1 1/8"	L241709961		1,80 x Pal	13,12 x Pal	536,40 x Pal
Skyline City Volcano	27x27x0,6-3 cm	100146070	G-140	5 x Cj	0,36 x Cj	14,90 x Cj
	10 5/8" x 10 5/8" x 1/4"-1 1/8"	L241710191		1,80 x Pal	13,12 x Pal	536,40 x Pal

LUXURY

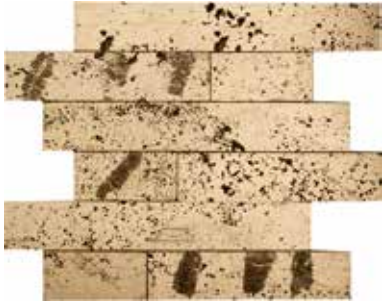

Luxury Modul Gold

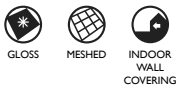

ENAMELED TRAVERTINE / TRAVERTINO ESMALTADO / TRAVERTIN ÉMAILLÉ

No supported grouting / No admite rejuntado / Ne peut pas être jointoyé.

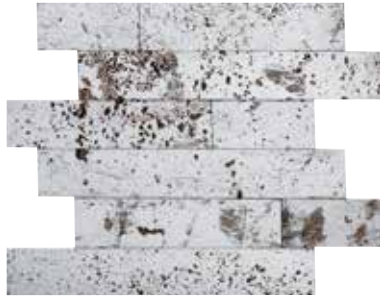

Luxury Modul Silver



ENAMELED TRAVERTINE / TRAVERTINO ESMALTADO / TRAVERTIN ÉMAILLÉ

No supported grouting / No admite rejuntado / Ne peut pas être jointoyé.



Luxury Modul Copper

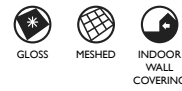

ENAMELED TRAVERTINE / TRAVERTINO ESMALTADO / TRAVERTIN ÉMAILLÉ

No supported grouting / No admite rejuntado / Ne peut pas être jointoyé.



Luxury Planet
14,8x1,4cm - 5 7/8"x1/2"



MARBLE / MÁRMOL / MARBRE
GRAPHITE / GRAFITO / GRAPHITE
SCREEN PRINTED / SERIGRAFÍA / ÉCRAN

Butech: Colorstuk Rapid Antracita



Luxury Allure
14,8x1,4cm - 5 7/8"x1/2"



MARBLE / MÁRMOL / MARBRE
GRAPHITE / GRAFITO / GRAPHITE
SCREEN PRINTED / SERIGRAFÍA / ÉCRAN

Butech: Colorstuk Rapid Moka

Description	Format	Codes	Group	Pcs	m2	Kg
Luxury Modul Gold	30x29x1-2 cm 11 3/4"x11 3/8"x3/8"-3/4"	I00113703 L241707081	G-156	5 x Cj 210 x Pal	0,44 x Cj 18,27 x Pal	16,46 x Cj 691,11 x Pal
Luxury Modul Silver	30x29x1-2 cm 11 3/4"x11 3/8"x3/8"-3/4"	I00113704 L241707021	G-156	5 x Cj 210 x Pal	0,44 x Cj 18,27 x Pal	15,11 x Cj 634,62 x Pal
Luxury Modul Copper	30x29x1-2 cm 11 3/4"x11 3/8"x3/8"-3/4"	I00113702 L241707041	G-156	5 x Cj 210 x Pal	0,44 x Cj 18,27 x Pal	15,84 x Cj 665,07 x Pal
Luxury Planet	30x30x1 cm 11 3/4"x11 3/4"x3/8"	I00161541 L241713151	G-136	10 x Box 600 x Pal	0,9 x Box 54 x Pal	20,70 x Box 1242 x Pal
Luxury Allure	30x30x1 cm 11 3/4"x11 3/4"x3/8"	I00161509 L241713141	G-136	10 x Box 600 x Pal	0,9 x Box 54 x Pal	20,70 x Box 1242 x Pal

MAGMA



Magma Hexagon Black

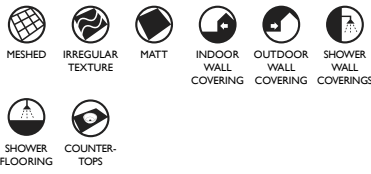

LAVA STONE / PIEDRA VOLCÁNICA / PIERREVOLCANIQUE

Butech: Colorstuk Rapid Negro



Magma Hexagon Grey



LAVA STONE / PIEDRA VOLCÁNICA / PIERREVOLCANIQUE

Butech: Colorstuk Rapid Gris

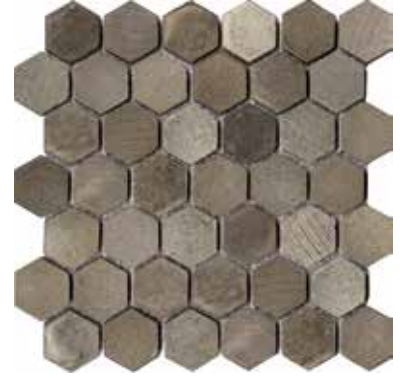

Magma Hexagon Beige



LAVA STONE / PIEDRA VOLCÁNICA / PIERREVOLCANIQUE

Butech: Colorstuk Rapid Beige



Floor Coverings Magma Hexagon Beige, Signature Shell

Description	Format	Codes	Group	Pcs	m2	Kg
Magma Hexagon Black	28,4x27,7x0,8 cm	100190417	G-131	11 x Cj	0,86 x Cj	14,45 x Cj
	11 1/8"x10 7/8"x3/8"	L241714571		594 x Pal	46,73 x Pal	780,51 x Pal
Magma Hexagon Grey	28,4x27,7x0,8 cm	100190425	G-131	11 x Cj	0,86 x Cj	14,45 x Cj
	11 1/8"x10 7/8"x3/8"	L241714581		594 x Pal	46,73 x Pal	780,51 x Pal
Magma Hexagon Beige	28,4x27,7x0,8 cm	100190433	G-131	11 x Cj	0,86 x Cj	14,45 x Cj
	11 1/8"x10 7/8"x3/8"	L241714591		594 x Pal	46,73 x Pal	780,51 x Pal

MAGMA



Wall Coverings Magma Hexagon Beige

INSTALLATION / INSTALACIÓN / INSTALLATION

INSTALLATION INSTALACIÓN INSTALLATION

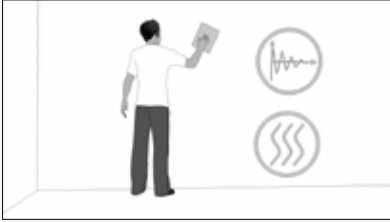

The surface on which the material is going to be installed shall be smooth and consistent. In addition, it shall be dry and clean.

La superficie sobre la que se va a colocar el material debe ser lisa y consistente. además de estar seca y limpia.

La surface où va être posé le matériau doit être lisse, ferme, sèche et propre.

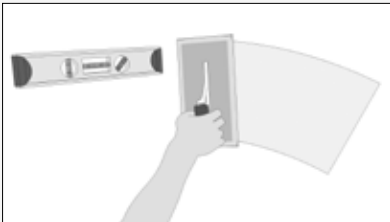

We recommend leveling the surface in order to create a white background.

Se aconseja nivelar la superficie para crear un fondo blanco.

Il est conseillé de mettre à niveau la surface pour créer un fond blanc.

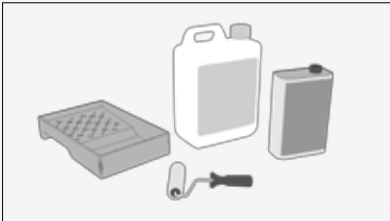

In the case of levels greater than 2 mm, the use of specific products is recommended.

En el caso de nivelados superiores a 2 mm se recomienda el uso de productos específicos.

Si la mise à niveau est supérieure à 2 mm, il est recommandé d'utiliser des produits spécifiques.



In order to maintain the good condition of the leveling product, the room temperature must be between 30 °C and 5 °C.

Para mantener el buen estado del producto de nivelación, la temperatura ambiente debe estar comprendida entre 30° C y 5° C.

Afin de maintenir le produit de nivellement en bon état, la température ambiante doit être entre 30 °C et 5 °C.

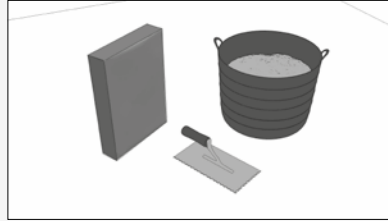

Prepare the adhesive following the manufacturer's instructions; in our case we recommend ONE-FLEX.

Se prepara el adhesivo siguiendo las instrucciones del fabricante, en nuestro caso recomendamos ONE-FLEX.

Préparer la colle en fonction des indications du fabricant. Nous recommandons l'utilisation de ONE-FLEX.

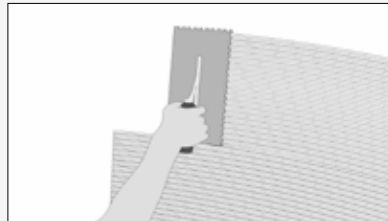

Next, we shall "comb" the adhesive with the notched side (minimum notch 3 mm.) Do not spread the cement-based adhesive over large areas to prevent it from drying before placing the material.

A continuación "peinamos" el adhesivo con el lado dentado (dentadura mínima de 3 mm). no se debe extender el cemento cola en grandes superficies para evitar que se reseque antes de colocar el material.

Puis, "peigner" le mortier colle avec le côté cranté (denture minimale 3 mm). Ne pas étendre le mortier colle sur de trop grandes surfaces pour éviter qu'il ne sèche trop avant de poser le matériau.

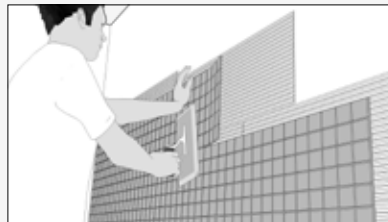

We install the sheet and press it evenly with a rubber trowel.

Colocamos la hoja y presionamos uniformemente la misma con una llana de goma.

Mettre en place la feuille puis exercer une légère pression uniforme à l'aide d'une taloche en caoutchouc.

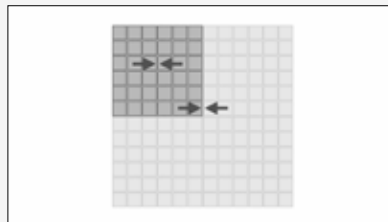

We shall ensure that the distance between the sheets is the same between pieces, resulting in a uniform installation, and that all joints have the same distance to each other.

Nos aseguramos que la distancia entre hojas sea

la misma que hay entre las piezas, resultando la colocación homogénea y que todas las juntas tengan la misma separación entre sí.

S'assurer que la distance entre les feuilles soit égale à celle existante entre les pièces, afin que la pose soit uniforme et tous les joints soient égaux.

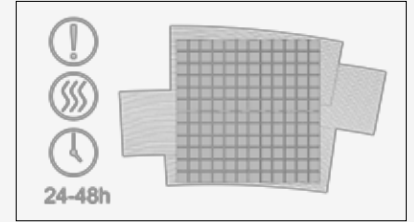

We shall let the adhesive dry for at least 24-48 hours. Before the adhesive sets, debris must be wiped off with a sponge or cloth.

Hay que dejar secar el adhesivo durante al menos 24-48 horas. Antes de que fragüe el adhesivo se deben retirar los restos del mismo con una esponja o un trapo.

Laisser prendre le mortier colle pendant 24-48 heures. Avant le durcissement du mortier-colle, enlever les restes à l'aide d'une éponge ou d'un chiffon.

GROUTING (Applicable only for mosaics with joint).

REJUNTADO (aplicable sólo para mosaicos con junta).

REJOINTOIEMENT (Applicable uniquement pour les mosaïques posées avec joint).

All pieces shall be perfectly clean and free of dust before grouting.

Todas las piezas deben estar perfectamente limpias y sin restos de residuos de polvo antes de proceder al rejuntado.

Toutes les pièces devront être propres et libres de poussière avant de rejointer.

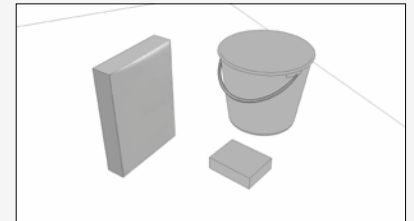

We recommend the use of Colorstuk rapid.

Se recomienda el uso de Colorstuk rapid.

Il est recommandé d'utiliser Colorstuk rapid.

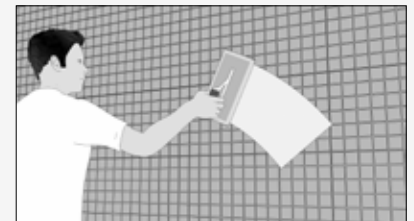

The grouting material is spread with a rubber trowel, filling joints well in all their depth.

Se extiende el material de rejunte con una llana de goma relleno bien las juntas en toda su profundidad.

Étendre le matériau de rejointoiement à l'aide d'une taloche en caoutchouc en remplissant bien les joints dans toute sa profondeur.

INSTALLATION / INSTALACIÓN / INSTALLATION

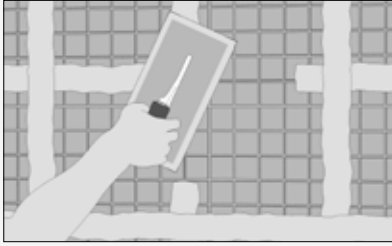

The same trowel shall be used to remove excess grout.

Se utilizará la misma llana para eliminar el exceso.

La même taloche sera utilisée pour enlever l'excès de matériau.

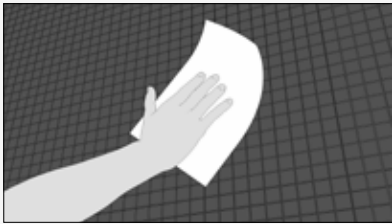

Before the grouting material dries, its remains shall be removed with a sponge or cloth.

Antes de que fragüe el material de rejunte se deben retirar los restos del mismo con una esponja o trapo.

Les restes de matériau utilisé pour le rejointoiement doivent être retirés à l'aide d'une éponge ou d'un chiffon avant qu'il ne prenne.

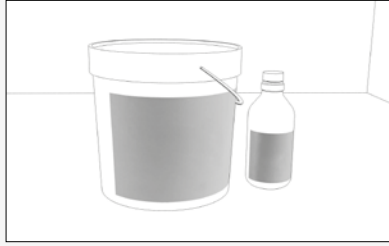

For applications exposed, directly or indirectly, to water, we recommend sealing the grout with a neutral product such as FILAFOB. It's also recommended Butech's Epotech as a grout. (see technical characteristics sheet)

Específicamente para instalaciones en las que el material vaya a estar en contacto con agua (directa o indirectamente) se recomienda sellar el adhesivo de rejunte aplicando un protector neutro tipo FILAFOB. También está recomendado el uso de Epotech de Butech como material de rejunte (Leer características técnicas del producto).

Pour les installations spécifiques où il est prévu que le matériau soit en contact avec l'eau (directement ou indirectement), il est recommandé de sceller le matériau de jointoiement en appliquant un protecteur neutre type FILAFOB. Il est également recommandé d'utiliser Epotech de Butech comme matériau de jointoiement (lire les caractéristiques techniques du produit).

You can find the detailed up-to-date installation guide by visiting our website www.anticcolonial.com

Puedes revisar estas instrucciones de instalación actualizadas y con mas detalle visitando nuestra pagina web www.anticcolonial.com

Les dernières mises à jour sur les conseils d'installation et des informations complémentaires sont disponibles sur notre site web www.anticcolonial.com



Wall Coverings Skyline Linear Broken Dark



Wall Coverings Victorian Trenzado Marmara Gris

VICTORIAN COLLECTION

.....



VICTORIAN COLLECTION

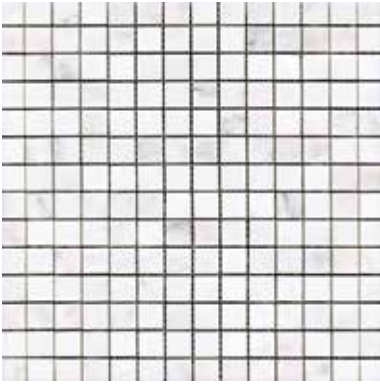

Victorian Blanco Marmara
2x2cm - 3/4"x3/4"



MARBLE / MÁRMOL / MARBRE

Butech: Colorstuk Rapid Blanco



Victorian Island Star White

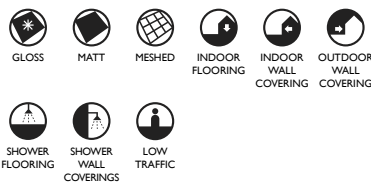

RECYCLED GLASS / VIDRIO RECICLADO /
VERRE RECYCLÉ

Butech: Colorstuk Rapid Blanco

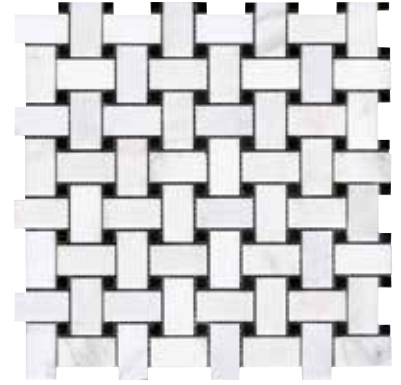

Victorian Trenzado Marmara Negro

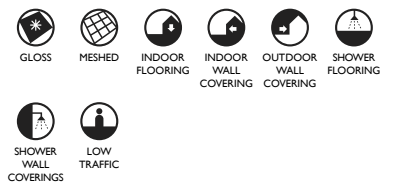

MARBLE / MÁRMOL / MARBRE

Butech: Colorstuk Rapid Blanco



Victorian Chain Marmara Mirror



MARBLE / MÁRMOL / MARBRE
GLASS / VIDRIO / VERRE

Butech: Colorstuk Rapid Blanco

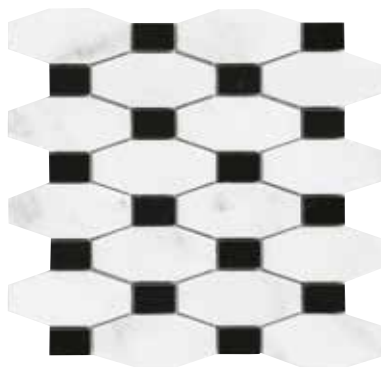

Victorian Chain Marmara-Marquina



MARBLE / MÁRMOL / MARBRE

Butech: Colorstuk Rapid Blanco



Victorian Diamond Marmara-Mirror



MARBLE / MÁRMOL / MARBRE
GLASS / VIDRIO / VERRE

Butech: Colorstuk Rapid Blanco

Description	Format	Codes	Group	Pcs	m2	Kg
Victorian Blanco Marmara (2)	29x29x1 cm	100000580	G-113	10 x Cj	0,84 x Cj	19,31 x Cj
	11 3/8"x11 3/8"x3/8"	L119487001		360 x Pal	30,28 x Pal	695,16 x Pal
Victorian Island Star White	24x24x0,7 cm	100200258	G-111	12 x Cj	0,69 x Cj	8,94 x Cj
	9 1/2"x9 1/2"x1/4"	L244007331		720 x Pal	41,47 x Pal	536,40 x Pal
Victorian Trenzado Marmara Negro	30x30x1 cm	100000333	G-126	10 x Cj	0,90 x Cj	23,18 x Cj
	11 3/4"x11 3/4"x3/8"	L114587001		360 x Pal	32,40 x Pal	834,48 x Pal
Victorian Chain Marmara Mirror	25,4x24,6x1 cm	100081159	G-138	10 x Cj	0,63 x Cj	17,22 x Cj
	10"x9 5/8"x3/8"	L108008751		480 x Pal	29,99 x Pal	826,56 x Pal
Victorian Chain Marmara-Marq.	25,4x24,6x1 cm	100081164	G-137	10 x Cj	0,63 x Cj	17,18 x Cj
	10"x9 5/8"x3/8"	L115979011		480 x Pal	29,99 x Pal	824,64 x Pal
Victorian Diamond Marmara-Mirror	32,9x28,3x1 cm	100081166	G-151	10 x Cj	0,93 x Cj	25,55 x Cj
	13"x11 1/8"x3/8"	L119379011		360 x Pal	33,48 x Pal	919,80 x Pal

VICTORIAN COLLECTION



Victorian Trezado Marmara Gris

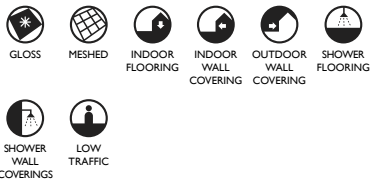

MARBLE / MÁRMOL / MARBRE
TRAVERTINE / TRAVERTINO / TRAVERTIN

Butech: Colorstuk Rapid Blanco



Victorian Mother of Pearl Brown



MOTHER OF PEARL / MADRE PERLA / NACRE

Butech: Colorstuk Special Brown



Victorian Mother of Pearl White



MOTHER OF PEARL / MADRE PERLA / NACRE

Butech: Colorstuk Special Nacaré



Victorian Mother of Pearl Grey



MOTHER OF PEARL / MADRE PERLA / NACRE

Butech: colorstuk Special Dark



Wall Coverings Victorian Mother of Pearl Grey

Description	Format	Codes	Group	Pcs	m2	Kg
Victorian Trezado Marmara Gris	30x30x1 cm	I00162246	G-126	10 x Cj	0,90 x Cj	23,18 x Cj
	11 3/4"x11 3/4"x3/8"	L241713351		360 x Pal	32,40 x Pal	834,48 x Pal
Victorian Mother of Pearl Brown	29x30,3x0,8 cm	I00153500	G-143	9 x Cj	0,79 x Cj	9,03 x Cj
	11 3/8"x11 11/16"x3/8"	L241710691		648 x Pal	56,93 x Pal	650,59 x Pal
Victorian Mother of Pearl White	29x30,3x0,8 cm	I00153478	G-143	9 x Cj	0,79 x Cj	9,03 x Cj
	11 3/8"x11 11/16"x3/8"	L241710671		648 x Pal	56,93 x Pal	650,59 x Pal
Victorian Mother of Pearl Grey	29x30,3x0,8 cm	I00153501	G-143	9 x Cj	0,79 x Cj	9,03 x Cj
	11 3/8"x11 11/16"x3/8"	L241710681		648 x Pal	56,93 x Pal	650,59 x Pal

INSTALLATION / INSTALACIÓN / INSTALLATION

INSTALLATION INSTALACIÓN INSTALLATION

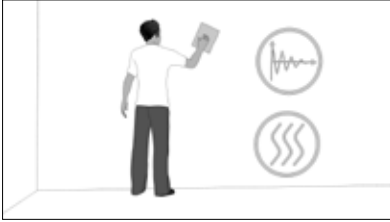

The surface on which the material is going to be installed shall be smooth and consistent. In addition, it shall be dry and clean.

La superficie sobre la que se va a colocar el material debe ser lisa y consistente. además de estar seca y limpia.

La surface où va être posé le matériau doit être lisse, ferme, sèche et propre.

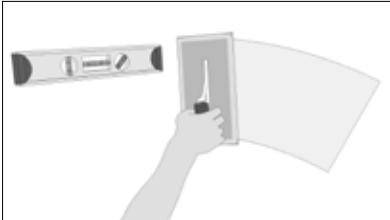

We recommend leveling the surface in order to create a white background.

Se aconseja nivelar la superficie para crear un fondo blanco.

Il est conseillé de mettre à niveau la surface pour créer un fond blanc.

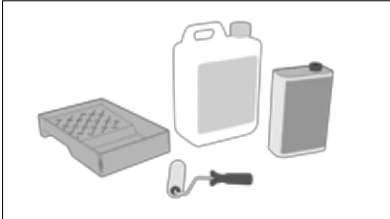

In the case of levels greater than 2 mm, the use of specific products is recommended.

En el caso de nivelados superiores a 2 mm se recomienda el uso de productos específicos.

Si la mise à niveau est supérieure à 2 mm, il est recommandé d'utiliser des produits spécifiques.

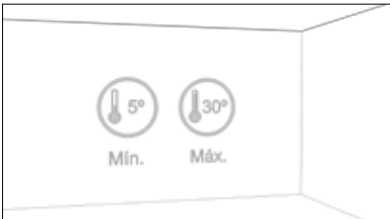

In order to maintain the good condition of the leveling product, the room temperature must be between 30 °C and 5 °C.

Para mantener el buen estado del producto de nivelación, la temperatura ambiente debe estar comprendida entre 30° C y 5°C.

Afin de maintenir le produit de nivellement en bon état, la température ambiante doit être entre 30 °C et 5 °C.

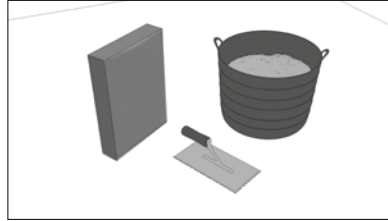

Prepare the adhesive following the manufacturer's instructions; in our case we recommend ONE-FLEX.

Se prepara el adhesivo siguiendo las instrucciones del fabricante, en nuestro caso recomendamos ONE-FLEX.

Préparer la colle en fonction des indications du fabricant. Nous recommandons l'utilisation de ONE-FLEX.

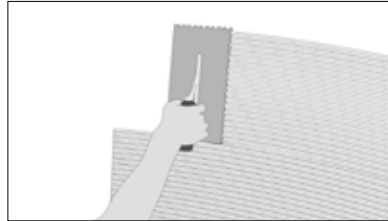

Next, we shall "comb" the adhesive with the notched side (minimum notch 3 mm.) Do not spread the cement-based adhesive over large areas to prevent it from drying before placing the material.

A continuación "peinamos" el adhesivo con el lado dentado (dentadura mínima de 3 mm). No se debe extender el cemento cola en grandes superficies para evitar que se reseque antes de colocar el material.

Puis, "peigner" le mortier colle avec le côté cranté (denture minimale 3 mm). Ne pas étendre le mortier colle sur de trop grandes surfaces pour éviter qu'il ne sèche trop avant de poser le matériau.



We install the sheet and press it evenly with a rubber trowel.

Colocamos la hoja y presionamos uniformemente la misma con una llana de goma.

Mettre en place la feuille puis exercer une légère pression uniforme à l'aide d'une taloche en caoutchouc.

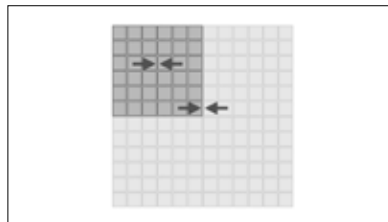

We shall ensure that the distance between the sheets is the same between pieces, resulting in a uniform installation, and that all joints have the same distance to each other.

Nos aseguramos que la distancia entre hojas sea la misma que hay entre las piezas, resultando la colocación homogénea y que todas las juntas tengan la misma separación entre sí.

S'assurer que la distance entre les feuilles soit égale à celle existante entre les pièces, afin que la pose soit uniforme et tous les joints soient égaux.

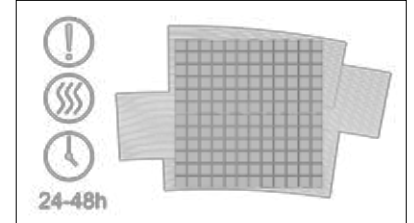

We shall let the adhesive dry for at least 24-48 hours. Before the adhesive sets, debris must be wiped off with a sponge or cloth.

Hay que dejar secar el adhesivo durante al menos 24-48 horas. Antes de que fragüe el adhesivo se deben retirar los restos del mismo con una esponja o un trapo.

Laisser prendre le mortier colle pendant 24-48 heures. Avant le durcissement du mortier-colle, enlever les restes à l'aide d'une éponge ou d'un chiffon.

GROUTING REJUNTADO

REJOINTOIEMENT

All pieces shall be perfectly clean and free of dust before grouting.

Todas las piezas deben estar perfectamente limpias y sin restos de residuos de polvo antes de proceder al rejuntado.

Toutes les pièces devront être propres et libres de poussière avant de rejointer.

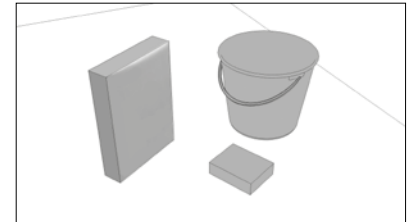

We recommend the use of Colorstuk rapid.

Se recomienda el uso de Colorstuk rapid.

Il est recommandé d'utiliser Colorstuk rapid.

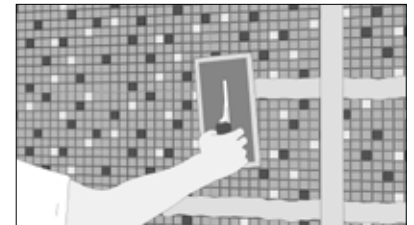

The grouting material is spread with a rubber trowel, filling joints well in all their depth.

Se extiende el material de rejunte con una llana de goma rellenando bien las juntas en toda su profundidad.

Étendre le matériau de rejointoiement à l'aide d'une taloche en caoutchouc en remplissant bien les joints dans toute sa profondeur.

INSTALLATION / INSTALACIÓN / INSTALLATION

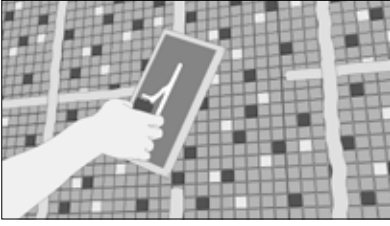

The same trowel shall be used to remove excess grout.

Se utilizará la misma llana para eliminar el exceso.

La même taloche sera utilisée pour enlever l'excès de matériau.

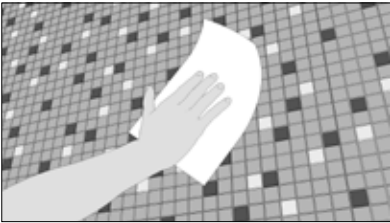

Before the grouting material dries, its remains shall be removed with a sponge or cloth.

Antes de que fragüe el material de rejunte se deben retirar los restos del mismo con una esponja o trapo.

Les restes de matériau utilisé pour le rejointoiement doivent être retirés à l'aide d'une éponge ou d'un chiffon avant qu'il ne prenne.

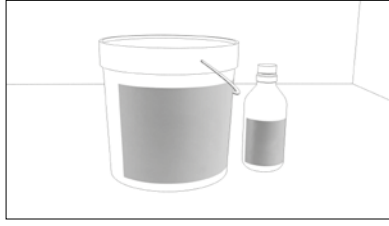

For applications exposed, directly or indirectly, to water, we recommend sealing the grout with a neutral product such as FILAFOB. It's also recommended Butech's Epotech as a grout, (see technical characteristics sheet)

Específicamente para instalaciones en las que el material vaya a estar en contacto con agua (directa o indirectamente) se recomienda sellar el adhesivo de rejunte aplicando un protector neutro tipo FILAFOB. También está recomendado el uso de Epotech de Butech como material de rejunte (Leer características técnicas del producto).

Pour les installations spécifiques où il est prévu que le matériau soit en contact avec l'eau (directement ou indirectement), il est recommandé de sceller le matériau de jointoiement en appliquant un protecteur neutre type FILAFOB. Il est également recommandé d'utiliser Epotech de Butech comme matériau de jointoiement (lire les caractéristiques techniques du produit).

You can find the detailed up-to-date installation guide by visiting our website www.anticcolonial.com

Puedes revisar estas instrucciones de instalación actualizadas y con mas detalle visitando nuestra pagina web www.anticcolonial.com

Les dernières mises à jour sur les conseils d'installation et des informations complémentaires sont disponibles sur notre site web www.anticcolonial.com



Wall Coverings Victorian Island Star-White



Wall Coverings Stark White

GLASS MOSAICS

.....

Glacier
Hexcube
Glaze
Flow
Edition
Luxe Mirror
Dados
Mini Iris
Dream
Armour
Stark
Arabia
Evoke
Harmony
Urban

GLACIER

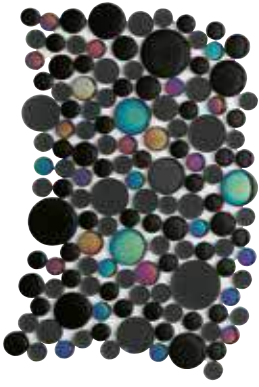

Glacier Moon Metallic Black



GLASS / VIDRIO / VERRE

Butech: Colorstuk 0-4 Negro



Glacier Moon Metallic White



GLASS / VIDRIO / VERRE

Butech: Colorstuk 0-4 Blanco



Glacier Moon Metallic Cremas



GLASS / VIDRIO / VERRE

Butech: Colorstuk 0-4 Blanco / Marfil

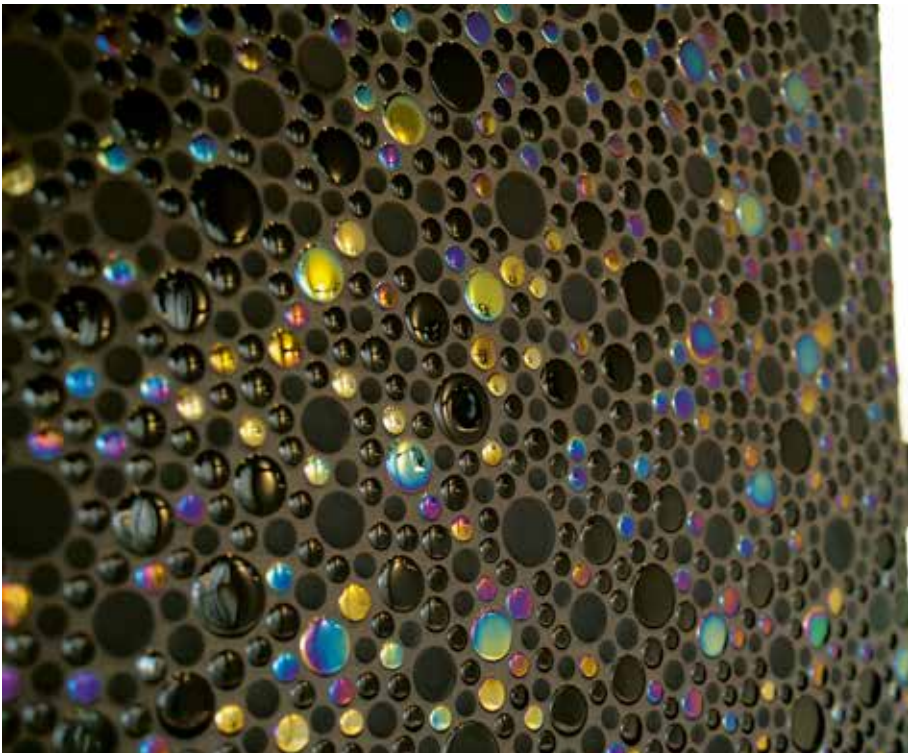

Wall Coverings Glacier Moon Metallic Black

Description	Format	Codes	Group	Pcs	m2	Kg
Glacier Moon Metallic Black	19x29x0,8 cm	100080373	G-119	11 x Cj	0,61 x Cj	8,69 x Cj
	7 1/2"x11 3/8"x3/8"	L240100021		792 x Pal	43,64 x Pal	625,68 x Pal
Glacier Moon Metallic White	19x29x0,8 cm	100080376	G-126	11 x Cj	0,61 x Cj	8,69 x Cj
	7 1/2"x11 3/8"x3/8"	L240100011		792 x Pal	43,64 x Pal	625,68 x Pal
Glacier Moon Metallic Cremas	19x29x0,8 cm	100080374	G-119	11 x Cj	0,61 x Cj	8,69 x Cj
	7 1/2"x11 3/8"x3/8"	L240100031		792 x Pal	43,64 x Pal	625,68 x Pal

HEXCUBE



Hexcube Blue



GLASS / VIDRIO / VERRE

Butech: Epotech Blanco



Hexcube Black



GLASS / VIDRIO / VERRE

Butech: Epotech Negro



Wall Coverings Hexcube Blue

Description	Format	Codes	Group	Pcs	m2	Kg
Hexcube Blue	30x29.5x0.8-1.8 cm	I00110387	G-159	8 x Cj	0,71 x Cj	17,06 x Cj
	11 3/4" x 11 5/8" x 3/8-3/4"	L242522321		288 x Pal	25,49 x Pal	614,02 x Pal
Hexcube Black	30x29.5x0.8-1.8 cm	I00110386	G-159	8 x Cj	0,71 x Cj	17,06 x Cj
	11 3/4" x 11 5/8" x 3/8-3/4"	L242522341		288 x Pal	25,49 x Pal	614,02 x Pal

GLAZE

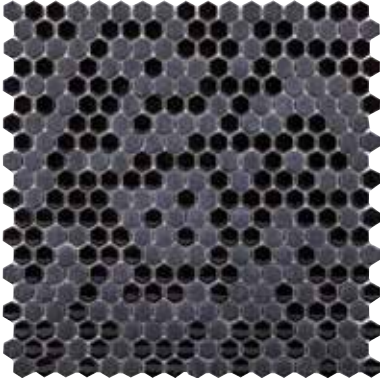

Glaze Mini Hexagon Black
1,5x1,5 cm - 5/8"x5/8"



GLASS / VIDRIO / VERRE

Butech: Colorstuk 0-4 Negro



Glaze Mini Hexagon Grey
1,5x1,5 cm - 5/8"x5/8"



GLASS / VIDRIO / VERRE

Butech: Colorstuk 0-4 Cemento

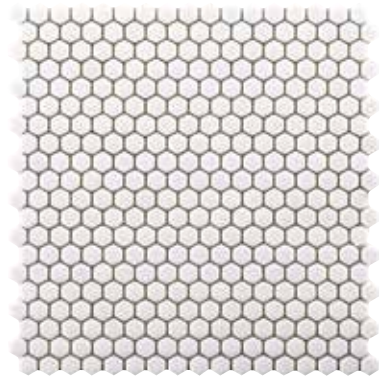

Glaze Mini Hexagon White
1,5x1,5 cm - 5/8"x5/8"



GLASS / VIDRIO / VERRE

Butech: Colorstuk 0-4 Blanco

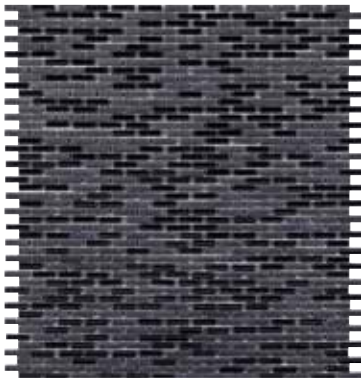

Glaze Micro Brick Black
2x0,5 cm - 3/4"x 1/4"



GLASS / VIDRIO / VERRE

Butech: Colorstuk 0-4 Negro



Glaze Micro Brick Grey
2x0,5 cm - 3/4"x 1/4"



GLASS / VIDRIO / VERRE

Butech: Colorstuk 0-4 Cemento

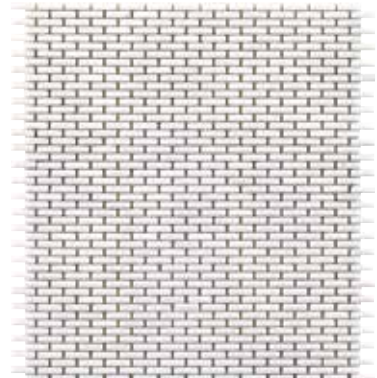

Glaze Micro Brick White
2x0,5 cm - 3/4"x 1/4"



GLASS / VIDRIO / VERRE

Butech: Colorstuk 0-4 Blanco

Description	Format	Codes	Group	Pcs	m2	Kg
Glaze Mini Hexagon Black (1,5)	29,5x30x0,6cm	100173148	G-113	10 x Cj	0,89 x Cj	7,03 x Cj
	11 5/8"x11 3/8"x1/4"	L244007111		600 x Pal	53,10 x Pal	421,80 x Pal
Glaze Mini Hexagon Grey (1,5)	29,5x30x0,6cm	100173149	G-113	10 x Cj	0,89 x Cj	7,03 x Cj
	11 5/8"x11 3/8"x1/4"	L244007081		600 x Pal	53,10 x Pal	421,80 x Pal
Glaze Mini Hexagon White (1,5)	29,5x30x0,6cm	100173163	G-113	10 x Cj	0,89 x Cj	7,03 x Cj
	11 5/8"x11 3/8"x1/4"	L244007131		600 x Pal	53,10 x Pal	421,80 x Pal
Glaze Micro Brick Black (2x0,5)	28,4x30x0,5cm	100173154	G-113	11 x Cj	0,94 x Cj	6,38 x Cj
	11 1/8"x11 3/8"x1/4"	L244007121		660 x Pal	56,23 x Pal	442,86 x Pal
Glaze Micro Brick Grey (2x0,5)	28,4x30x0,5cm	100173147	G-113	11 x Cj	0,94 x Cj	6,38 x Cj
	11 1/8"x11 3/8"x1/4"	L244007071		660 x Pal	56,23 x Pal	442,86 x Pal
Glaze Micro Brick White (2x0,5)	28,4x30x0,5cm	100173162	G-113	11 x Cj	0,94 x Cj	6,38 x Cj
	11 1/8"x11 3/8"x1/4"	L244007091		660 x Pal	56,23 x Pal	442,86 x Pal

GLAZE



Glaze Brick Black
4,2x2 cm - | 5/8" x 3/4"



GLASS / VIDRIO / VERRE

Butech: Colorstuk 0-4 Negro



Glaze Brick Grey
4,2x2 cm - | 5/8" x 3/4"



GLASS / VIDRIO / VERRE

Butech: Colorstuk 0-4 Cemento



Glaze Brick White
4,2x2 cm - | 5/8" x 3/4"



GLASS / VIDRIO / VERRE

Butech: Colorstuk 0-4 Blanco

Mosaics



Wall Coverings Glaze Brick White

Description	Format	Codes	Group	Pcs	m2	Kg
Glaze Brick Black (4,2x2)	32,2x30x0,6cm 12 5/8" x 11 3/8" x 1/4"	I00173153	G-123	11 x Cj	1,06 x Cj	8,29 x Cj
		L244007061		594 x Pal	57,38 x Pal	447,88 x Pal
Glaze Brick Grey (4,2x2)	32,2x30x0,6cm 12 5/8" x 11 3/8" x 1/4"	I00173146	G-123	11 x Cj	1,06 x Cj	8,29 x Cj
		L244007101		594 x Pal	57,38 x Pal	447,88 x Pal
Glaze Brick White (4,2x2)	32,2x30x0,6cm 12 5/8" x 11 3/8" x 1/4"	I00173171	G-123	11 x Cj	1,06 x Cj	8,29 x Cj
		L244007141		594 x Pal	57,38 x Pal	447,88 x Pal

GLAZE

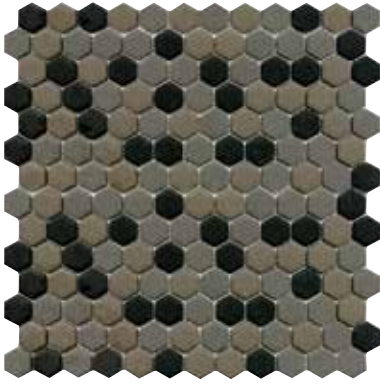

Glaze Hexagon Greys / Black Matt



GLASS / VIDRIO / VERRE

Butech: Colorstuk 0-4 Gris



Glaze Hexagon Greys Matt



GLASS / VIDRIO / VERRE

Butech: Colorstuk 0-4 Gris



Glaze Hexagon Beiges Matt



GLASS / VIDRIO / VERRE

Butech: Colorstuk 0-4 Blanco



Glaze Hexagon Whites Matt



GLASS / VIDRIO / VERRE

Butech: Colorstuk 0-4 Blanco



Wall Coverings Glaze Hexagon Beiges Matt

Description	Format	Codes	Group	Pcs	m2	Kg
Glaze Hexagon Greys/Blacks Matt	30,2x30x0,6 cm	100169274	G-113	11 x Cj	0,99 x Cj	12,52 x Cj
	11 7/8" x 11 3/4" x 1/4"	L244006801		660 x Pal	59,79 x Pal	751,74 x Pal
Glaze Hexagon Greys Matt	30,2x30x0,6 cm	100169273	G-113	11 x Cj	0,99 x Cj	12,52 x Cj
	11 7/8" x 11 3/4" x 1/4"	L244006791		660 x Pal	59,79 x Pal	751,74 x Pal
Glaze Hexagon Beiges Matt	30,2x30x0,6 cm	100169291	G-113	11 x Cj	0,99 x Cj	12,52 x Cj
	11 7/8" x 11 3/4" x 1/4"	L244006781		660 x Pal	59,79 x Pal	751,74 x Pal
Glaze Hexagon Whites Matt	30,2x30x0,6 cm	100169236	G-113	11 x Cj	0,99 x Cj	12,52 x Cj
	11 7/8" x 11 3/4" x 1/4"	L244006811		660 x Pal	59,79 x Pal	751,74 x Pal

GLAZE

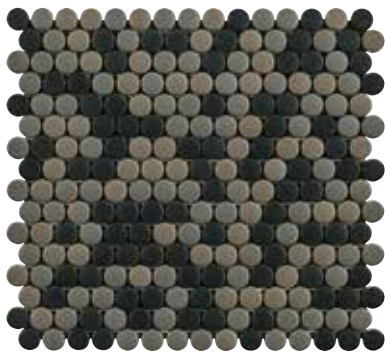

Glaze Dots Greys / Black Matt



GLASS / VIDRIO / VERRE

Butech: Colorstuk 0-4 Gris

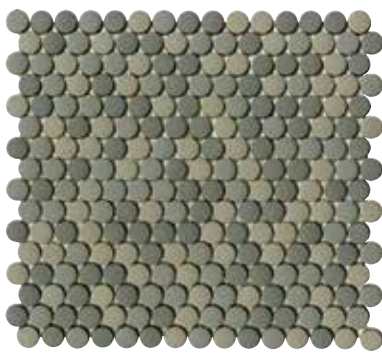

Glaze Dots Greys Matt



GLASS / VIDRIO / VERRE

Butech: Colorstuk 0-4 Gris



Glaze Dots Beiges Matt



GLASS / VIDRIO / VERRE

Butech: Colorstuk 0-4 Blanco

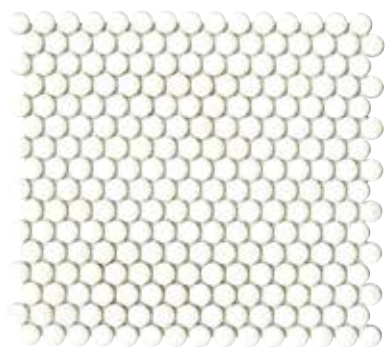

Glaze Dots Whites Matt



GLASS / VIDRIO / VERRE

Butech: Colorstuk 0-4 Blanco

Description	Format	Codes	Group	Pcs	m2	Kg
Glaze Dots Greys/Blacks Matt	31,5x29x0,6 cm 12 3/8" x 11 3/8" x 1/4"	I00169280 L244006761	G-113	11 x Cj 660 x Pal	1,01 x Cj 60,29 x Pal	10,74 x Cj 644,16 x Pal
Glaze Dots Greys Matt	31,5x29x0,6 cm 12 3/8" x 11 3/8" x 1/4"	I00169235 L244006751	G-113	11 x Cj 660 x Pal	1,01 x Cj 60,29 x Pal	10,74 x Cj 644,16 x Pal
Glaze Dots Beiges Matt	31,5x29x0,6 cm 12 3/8" x 11 3/8" x 1/4"	I00169259 L244006741	G-113	11 x Cj 660 x Pal	1,01 x Cj 60,29 x Pal	10,74 x Cj 644,16 x Pal
Glaze Dots Whites Matt	31,5x29x0,6 cm 12 3/8" x 11 3/8" x 1/4"	I00169290 L244006771	G-113	11 x Cj 660 x Pal	1,01 x Cj 60,29 x Pal	10,74 x Cj 644,16 x Pal

FLOW



Flow Hexagon White



GLASS / VIDRIO / VERRE

Butech: Colorstuk Special White



Flow Hexagon Golden



GLASS / VIDRIO / VERRE

Butech: Colorstuk Special Vanilla



Flow Hexagon Black



GLASS / VIDRIO / VERRE

Butech: Colorstuk Special Dark



Flow Brick White
7,5x1,3cm - 3"x1/2"



GLASS / VIDRIO / VERRE

Butech: Colorstuk Special White



Flow Brick Golden
7,5x1,3cm - 3"x1/2"



GLASS / VIDRIO / VERRE

Butech: Colorstuk Special Vanilla



Flow Brick Black
7,5x1,3cm - 3"x1/2"



GLASS / VIDRIO / VERRE

Butech: Colorstuk Special Dark

Description	Format	Codes	Group	Pcs	m2	Kg
Flow Hexagon White	29,1x29,4x0,5 cm	100160526	G-126	15 x Cj	1,28 x Cj	13,98 x Cj
	11 1/2"x11 5/8"x1/4"	L244006291		720 x Pal	61,59 x Pal	671,04 x Pal
Flow Hexagon Golden	29,1x29,4x0,5 cm	100160524	G-126	15 x Cj	1,28 x Cj	13,98 x Cj
	11 1/2"x11 5/8"x1/4"	L244006301		720 x Pal	61,59 x Pal	671,04 x Pal
Flow Hexagon Black	29,1x29,4x0,5 cm	100160523	G-126	15 x Cj	1,28 x Cj	13,98 x Cj
	11 1/2"x11 5/8"x1/4"	L244006351		720 x Pal	61,59 x Pal	671,04 x Pal
Flow Brick White	29,6x31,2x0,5 cm	100160522	G-126	15 x Cj	1,38 x Cj	15,52 x Cj
	11 5/8"x12 1/4"x1/4"	L244006251		720 x Pal	66,49 x Pal	745,20 x Pal
Flow Brick Golden	29,6x31,2x0,5 cm	100160535	G-126	15 x Cj	1,38 x Cj	15,52 x Cj
	11 5/8"x12 1/4"x1/4"	L244006311		720 x Pal	66,49 x Pal	745,20 x Pal
Flow Brick Black	29,6x31,2x0,5 cm	100160534	G-126	15 x Cj	1,38 x Cj	15,52 x Cj
	11 5/8"x12 1/4"x1/4"	L244006361		720 x Pal	66,49 x Pal	745,20 x Pal

FLOW

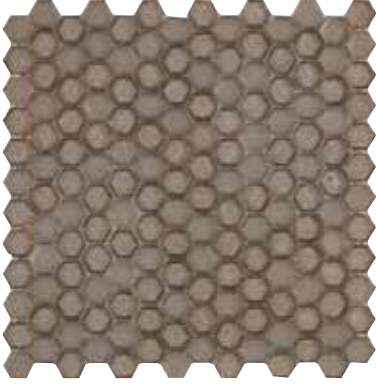

Flow Hexagon Tobacco



GLASS / VIDRIO / VERRE

Butech: Colorstuk Special Brown



Flow Brick Tobacco
7,5x1,3cm - 3"x1/2"



GLASS / VIDRIO / VERRE

Butech: Colorstuk Special Brown



Wall Coverings Flow Hexagon Tobacco

Description	Format	Codes	Group	Pcs	m2	Kg
Flow Hexagon Tobacco	29,1x29,4x0,5 cm	I00160525	G-126	15 x Cj	1,28 x Cj	13,98 x Cj
	11 1/2"x11 5/8"x1/4"	L244006321		720 x Pal	61,59 x Pal	671,04 x Pal
Flow Brick Tobacco	29,6x31,2x0,5 cm	I00160536	G-126	15 x Cj	1,38 x Cj	15,52 x Cj
	11 5/8"x12 1/4"x1/4"	L244006261		720 x Pal	66,49 x Pal	745,20 x Pal

EDITION



Edition Rectangular Grey
7,2x2,2 cm - 2 7/8"x7/8"



GLASS / VIDRIO / VERRE

Butech: Colorstuk Special Dark

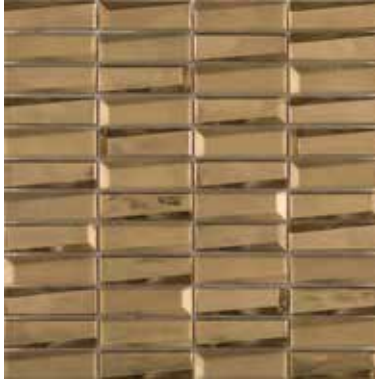

Edition Rectangular Gold
7,2x2,2 cm - 2 7/8"x7/8"



GLASS / VIDRIO / VERRE

Butech: Colorstuk 0-4 Bahama



Edition Rectangular White
7,2x2,2 cm - 2 7/8"x7/8"



GLASS / VIDRIO / VERRE

Butech: Colorstuk Special Nacaré



Wall Coverings Edition Rectangular Grey

Description	Format	Codes	Group	Pcs	m2	Kg
Edition Rectangular Grey	29,8x29,8x0,7 cm	100161755	G-153	11 x Cj	0,97 x Cj	12,10 x Cj
	11 3/4"x11 3/4"x1/4"	L241712901		594 x Pal	52,74 x Pal	653,40 x Pal
Edition Rectangular Gold	29,8x29,8x0,7 cm	100161728	G-153	11 x Cj	0,97 x Cj	12,10 x Cj
	11 3/4"x11 3/4"x1/4"	L241712941		594 x Pal	52,74 x Pal	653,40 x Pal
Edition Rectangular White	29,8x29,8x0,7 cm	100161762	G-153	11 x Cj	0,97 x Cj	12,10 x Cj
	11 3/4"x11 3/4"x1/4"	L241712911		594 x Pal	52,74 x Pal	653,40 x Pal

LUXE MIRROR



Luxe Mirror Hexagon



GLASS / VIDRIO / VERRE

Butech: Colorstuk Special Nacaré

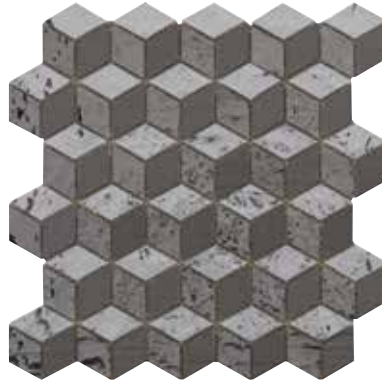

Luxe Mirror Cubes



GLASS / VIDRIO / VERRE

Butech: Colorstuk Special Nacaré



Luxe Mirror Strip



GLASS / VIDRIO / VERRE

Butech: Colorstuk Special Nacaré



Wall Coverings Luxe Mirror Hexagon

Description	Format	Codes	Group	Pcs	m2	Kg
Luxe Mirror Hexagon	31,6x32,5x0,3 cm	I00161540	G-137	10 x Cj	1,02 x Cj	4,14 x Cj
	12 1/2"x12 3/4"x1/8"	L244006391		600 x Pal	61,62 x Pal	248,40 x Pal
Luxe Mirror Cubes	32,5x32,5x0,3 cm	I00161536	G-137	10 x Cj	1,05 x Cj	4,14 x Cj
	12 3/4"x12 3/4"x1/8"	L244006381		600 x Pal	63,37 x Pal	248,40 x Pal
Luxe Mirror Strip	27,8x32,9x0,3 cm	I00161528	G-137	10 x Cj	0,91 x Cj	4,14 x Cj
	11"x13"x1/8"	L244006401		600 x Pal	54,87 x Pal	248,40 x Pal

DADOS



Dados Blue
2,4x2,4cm - 1" x 1"

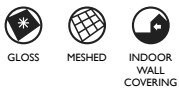

GLASS / VIDRIO / VERRE

No supported grouting / No admite rejuntado /
Ne peut pas être jointoyé. Ne peut pas être jointoyé.



Dados Earth
2,4x2,4cm - 1" x 1"

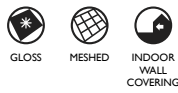

GLASS / VIDRIO / VERRE

No supported grouting / No admite rejuntado /
Ne peut pas être jointoyé.



Dados Pearl Cream
2x2cm - 3/4" x 3/4"



GLASS / VIDRIO / VERRE

No supported grouting / No admite rejuntado /
Ne peut pas être jointoyé.

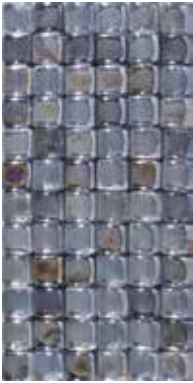

Dados Metal
2,4x2,4cm - 1" x 1"

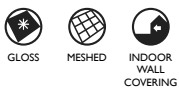

GLASS / VIDRIO / VERRE

No supported grouting / No admite rejuntado /
Ne peut pas être jointoyé.



Wall Coverings DADOS Metal

Description	Format	Codes	Group	Pcs	m2	Kg
Dados Blue (2,4)	15x30x1,4 cm	100112124	G-110	10 x Cj	0,45 x Cj	10,35 x Cj
	5 7/8" x 11 3/4" x 1/2"	L244001191		720 x Pal	32,40 x Pal	745,20 x Pal
Dados Earth (2,4)	15x30x1,4 cm	100112125	G-110	10 x Cj	0,45 x Cj	10,35 x Cj
	5 7/8" x 11 3/4" x 1/2"	L244001081		720 x Pal	32,40 x Pal	745,20 x Pal
Dados Pearl Cream (2)	13,8x29,7x1,4	100146031	G-110	14 x Cj	0,63 x Cj	12,74 x Cj
	5 3/8" x 11 3/4" x 1/2"	L244004851		756 x Pal	34,02 x Pal	687,96 x Pal
Dados Metal (2,4)	15,2x30,5x1,8 cm	100103990	G-110	10 x Cj	0,45 x Cj	17,80 x Cj
	6" x 12" x 3/4"	L244000981		480 x Pal	21,60 x Pal	854,40 x Pal

MINI IRIS



Mini Iris White Pearl
1x1cm - 3/8"x3/8"

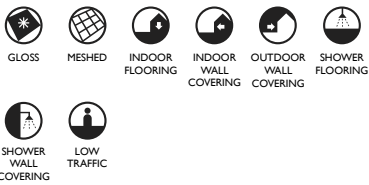

GLASS / VIDRIO / VERRE

Butech: Colorstuk 0-4 Blanco



Mini Iris Cream Pearl
1x1cm - 3/8"x3/8"

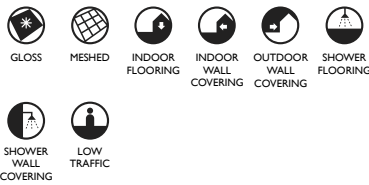

GLASS / VIDRIO / VERRE

Butech: Colorstuk 0-4 Bahama



Mini Iris Grey Pearl
1x1cm - 3/8"x3/8"

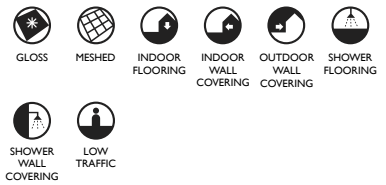

GLASS / VIDRIO / VERRE

Butech: Colorstuk 0-4 Gris

Mosaics



Mini Iris Black Pearl
1x1cm - 3/8"x3/8"

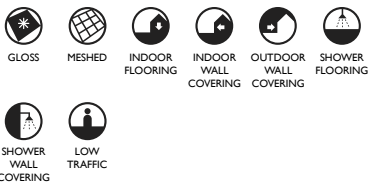

GLASS / VIDRIO / VERRE

Butech: Colorstuk 0-4 Negro



Wall Coverings Mini Iris Black Pearl

Description	Format	Codes	Group	Pcs	m2	Kg
Mini Iris White Pearl (1)	31,5x31,5x0,4 cm 12 3/8"x12 3/8"x1/8"	I00121438 L244004051	G-118	16 x Cj 960 x Pal	1,62 x Cj 97,08 x Pal	9,94 x Cj 596,16 x Pal
Mini Iris Cream Pearl (1)	31,5x31,5x0,4 cm 12 3/8"x12 3/8"x1/8"	I00121436 L244004021	G-118	16 x Cj 960 x Pal	1,62 x Cj 97,08 x Pal	9,94 x Cj 596,16 x Pal
Mini Iris Grey Pearl (1)	31,5x31,5x0,4 cm 12 3/8"x12 3/8"x1/8"	I00121437 L244004041	G-118	16 x Cj 960 x Pal	1,62 x Cj 97,08 x Pal	9,94 x Cj 596,16 x Pal
Mini Iris Black Pearl (1)	31,5x31,5x0,4 cm 12 3/8"x12 3/8"x1/8"	I00121435 L244004031	G-118	16 x Cj 960 x Pal	1,62 x Cj 97,08 x Pal	9,94 x Cj 596,16 x Pal

DREAM

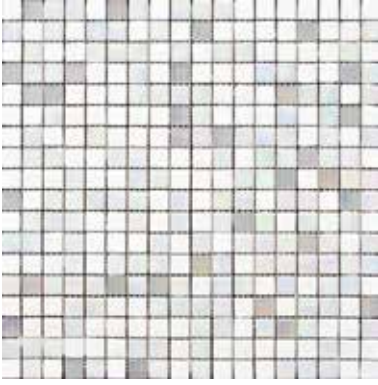

Dream Mix Whites
1,4x1,4cm - 1/2"x1/2"

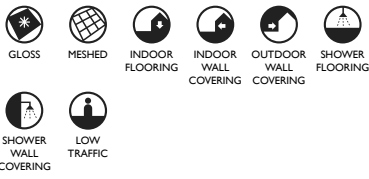

RECYCLED GLASS / VIDRIO RECICLADO / VERRE RECYCLÉ

Butech: Colorstuk 0-4 Blanco



Dream White
1,4x1,4cm - 1/2"x1/2"



RECYCLED GLASS / VIDRIO RECICLADO / VERRE RECYCLÉ

Butech: Colorstuk 0-4 Blanco



Wall Coverings Dream Mix Whites

Description	Format	Codes	Group	Pcs	m2	Kg
Dream Mix Whites (1,4)	29,5x29,5x0,4 cm	100086102	G-111	20 x Cj	1,74 x Cj	13,04 x Cj
	11 5/8"x11 5/8"x1/8"	L24400241		1200 x Pal	104,43 x Pal	782,40 x Pal
Dream White (1,4)	29,5x29,5x0,4 cm	100153005	G-111	20 x Cj	1,74 x Cj	15,52 x Cj
	11 5/8"x11 5/8"x1/8"	L244005331		1200 x Pal	104,46 x Pal	931,20 x Pal

ARMOUR



Armour Caramel
2,7x2,7cm - | 1/8"x1 1/8"

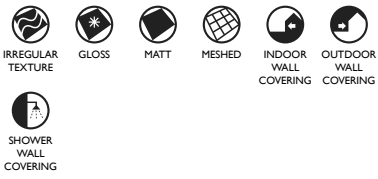

GLASS / VIDRIO / VERRE

Butech: Colorstuk Special Brown



Armour Black
2,7x2,7cm - | 1/8"x1 1/8"



GLASS / VIDRIO / VERRE

Butech: Colorstuk Special Dark



Wall Coverings Armour Caramel

Description	Format	Codes	Group	Pcs	m2	Kg
Armour Caramel (2,7)	30x30x0,8 cm	I00112118	G-114	11 x Cj	0,99 x Cj	17,38 x Cj
	11 3/4"x11 3/4"x3/8"	L244001111		594 x Pal	53,46 x Pal	938,52 x Pal
Armour Black (2,7)	30x30x0,8 cm	I00112117	G-114	11 x Cj	0,99 x Cj	17,38 x Cj
	11 3/4"x11 3/4"x3/8"	L244001061		594 x Pal	53,46 x Pal	938,52 x Pal

STARK



Stark White
1,4x4,7cm - 1/2"x1 7/8"



GLASS / VIDRIO / VERRE

Butech: Colorstuk Special White



Stark Grey
1,4x4,7cm - 1/2"x1 7/8"



GLASS / VIDRIO / VERRE

Butech: Colorstuk Special Nacaré

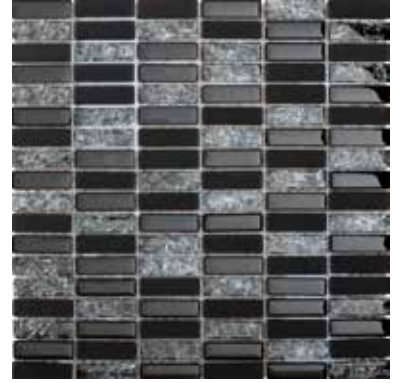

Stark Black
1,4x4,7cm - 1/2"x1 7/8"



GLASS / VIDRIO / VERRE

Butech: Colorstuk Special Dark



Wall Coverings Stark White

Description	Format	Codes	Group	Pcs	m2	Kg
Stark White (1,4X4,7)	29,7x30x0,8 cm	100112133	G-113	11 x Cj	0,98 x Cj	16,85 x Cj
	11 3/4"x11 3/4"x3/8"	L244001071		594 x Pal	52,93 x Pal	910,01 x Pal
Stark Grey (1,4X4,7)	29,7x30x0,8 cm	100112132	G-113	11 x Cj	0,98 x Cj	16,85 x Cj
	11 3/4"x11 3/4"x3/8"	L244001051		594 x Pal	52,93 x Pal	910,01 x Pal
Stark Black (1,4X4,7)	29,7x30x0,8 cm	100112131	G-113	11 x Cj	0,98 x Cj	16,85 x Cj
	11 3/4"x11 3/4"x3/8"	L244001041		594 x Pal	52,93 x Pal	910,01 x Pal

ARABIA



Arabia Silver
1,5x1,5cm - 5/8"x5/8"



RECYCLED GLASS / VIDRIO RECICLADO / VERRE RECYCLÉ

Butech: Colorstuk 0-4 Blanco

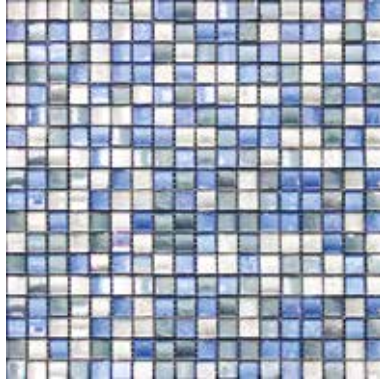

Arabia Mix Blue Silver
1,5x1,5cm - 5/8"x5/8"



RECYCLED GLASS / VIDRIO RECICLADO / VERRE RECYCLÉ

Butech: Colorstuk 0-4 Blanco

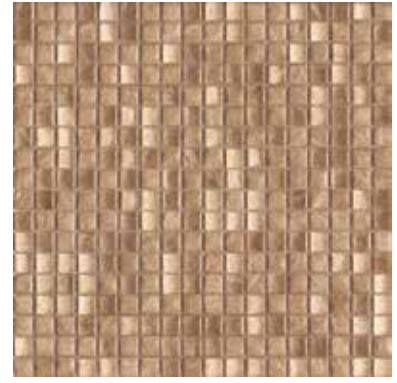

Arabia Sun
1,5x1,5cm - 5/8"x5/8"



RECYCLED GLASS / VIDRIO RECICLADO / VERRE RECYCLÉ

Butech: Colorstuk 0-4 Beige



Arabia Gold
1,5x1,5cm - 5/8"x5/8"



RECYCLED GLASS / VIDRIO RECICLADO / VERRE RECYCLÉ

Butech: Colorstuk 0-4 Bahama



Wall Coverings Arabia Gold

Description	Format	Codes	Group	Pcs	m2	Kg
Arabia Silver (1,5)	29,5x29,5x0,4 cm 11 5/8"x11 5/8"x1/8"	100092712	G-126	20 x Cj	1,74 x Cj	13,76 x Cj
		L244000511		1200 x Pal	104,40 x Pal	825,60 x Pal
Arabia Mix Blue Silver (1,5)	29,5x29,5x0,4 cm 11 5/8"x11 5/8"x1/8"	100092710	G-133	20 x Cj	1,74 x Cj	13,76 x Cj
		L244000521		1200 x Pal	104,40 x Pal	825,60 x Pal
Arabia Sun (1,5)	29,5x29,5x0,4 cm 11 5/8"x11 5/8"x1/8"	100146007	G-126	20 x Cj	1,74 x Cj	13,76 x Cj
		L241710181		1200 x Pal	104,40 x Pal	825,60 x Pal
Arabia Gold (1,5)	29,5x29,5x0,4 cm 11 5/8"x11 5/8"x1/8"	100092709	G-126	20 x Cj	1,74 x Cj	13,76 x Cj
		L244000531		1200 x Pal	104,40 x Pal	825,60 x Pal

EVOKE



Evoke Black

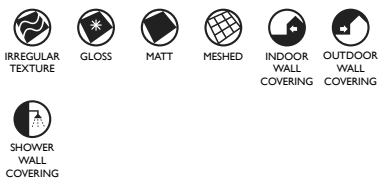

GLASS / VIDRIO / VERRE

Butech: colorstuk Special Dark



Evoke Caramel

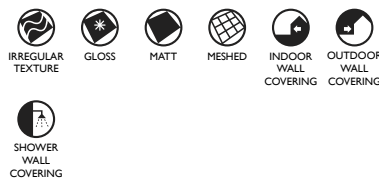

GLASS / VIDRIO / VERRE

Butech: Colorstuk Special Vanilla



Evoke Silver

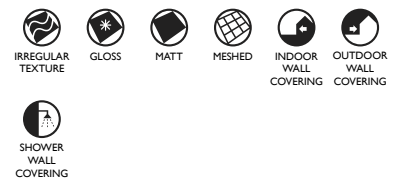

GLASS / VIDRIO / VERRE

Butech: Colorstuk Special Nacaré



Evoke Form Black

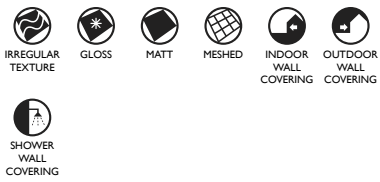

GLASS / VIDRIO / VERRE

Butech: Colorstuk Special Dark



Evoke Form Caramel

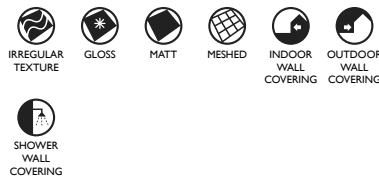

GLASS / VIDRIO / VERRE

Butech: Colorstuk Special Vanilla



Evoke Form Silver

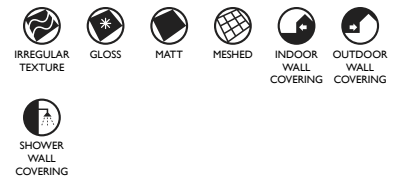

GLASS / VIDRIO / VERRE

Butech: Colorstuk Special Nacaré

Description	Format	Codes	Group	Pcs	m2	Kg
Evoke Black	29.5x29.5x0.8 cm	100153512	G-131	10 x Cj	0,87 x Cj	14,30 x Cj
	11 5/8"x11 5/8"x3/8"	L241710871		360 x Pal	31,32 x Pal	514,80 x Pal
Evoke Caramel	29.5x29.5x0.8 cm	100153514	G-131	10 x Cj	0,87 x Cj	14,30 x Cj
	11 5/8"x11 5/8"x3/8"	L241710881		360 x Pal	31,32 x Pal	514,80 x Pal
Evoke Silver	29.5x29.5x0.8 cm	100153519	G-131	10 x Cj	0,87 x Cj	14,30 x Cj
	11 5/8"x11 5/8"x3/8"	L241710931		360 x Pal	31,32 x Pal	514,80 x Pal
Evoke Form Black	25.7x14.8x0.95 cm	100153515	G-111	20 x Cj	0,76 x Cj	15,80 x Cj
	10 1/8"x5 13/16"x3/8"	L241710911		720 x Pal	27,38 x Pal	568,80 x Pal
Evoke Form Caramel	25.7x14.8x0.95 cm	100153517	G-111	20 x Cj	0,76 x Cj	15,80 x Cj
	10 1/8"x5 13/16"x3/8"	L241710921		720 x Pal	27,38 x Pal	568,80 x Pal
Evoke Form Silver	25.7x14.8x0.95 cm	100153518	G-111	20 x Cj	0,76 x Cj	15,80 x Cj
	10 1/8"x5 13/16"x3/8"	L241710901		720 x Pal	27,38 x Pal	568,80 x Pal

HARMONY



Harmony Arrow Coltan



GLASS / VIDRIO / VERRE

Butech: Colorstuk Special Dark



Harmony Arrow Gold



GLASS / VIDRIO / VERRE

Butech: Colorstuk Special Vanilla



Harmony Arrow Silver



GLASS / VIDRIO / VERRE

Butech: Colorstuk Special Nacaré



Harmony Strip Coltan



GLASS / VIDRIO / VERRE

Butech: Colorstuk Special Dark



Harmony Strip Gold



GLASS / VIDRIO / VERRE

Butech: Colorstuk Special Vanilla



Harmony Strip Silver



GLASS / VIDRIO / VERRE

Butech: Colorstuk Special Nacaré

Description	Format	Codes	Group	Pcs	m2	Kg
Harmony Arrow Coltan	25,8x28,4x0,8 cm 10 3/16"x11 3/16"x3/8"	I00153521	G-125	11 x Cj	0,80 x Cj	13,20 x Cj
		L241710711		528 x Pal	38,68 x Pal	633,60 x Pal
Harmony Arrow Gold	25,8x28,4x0,8 cm 10 3/16"x11 3/16"x3/8"	I00153522	G-125	11 x Cj	0,80 x Cj	13,20 x Cj
		L241710721		528 x Pal	38,68 x Pal	633,60 x Pal
Harmony Arrow Silver	25,8x28,4x0,8 cm 10 3/16"x11 3/16"x3/8"	I00153523	G-125	11 x Cj	0,80 x Cj	13,20 x Cj
		L241710701		528 x Pal	38,68 x Pal	633,60 x Pal
Harmony Strip Coltan	29,4x30x0,8 cm 11 9/16"x11 3/4"x3/8"	I00153524	G-134	11 x Cj	0,97 x Cj	16,50 x Cj
		L241710771		528 x Pal	46,56 x Pal	792 x Pal
Harmony Strip Gold	29,4x30x0,8 cm 11 9/16"x11 3/4"x3/8"	I00153525	G-134	11 x Cj	0,97 x Cj	16,50 x Cj
		L241710741		528 x Pal	46,56 x Pal	792 x Pal
Harmony Strip Silver	29,4x30x0,8 cm 11 9/16"x11 3/4"x3/8"	I00153526	G-134	11 x Cj	0,97 x Cj	16,50 x Cj
		L241710731		528 x Pal	46,56 x Pal	792 x Pal

URBAN



Urban Line Iron



GLASS / VIDRIO / VERRE

Butech: Colorstuk Special White



Urban Line Lead



GLASS / VIDRIO / VERRE

Butech: Colorstuk Special Rapid Nacaré



Urban Line Silver



GLASS / VIDRIO / VERRE

Butech: Colorstuk Special Rapid Nacaré



Urban Line Nickel



GLASS / VIDRIO / VERRE

Butech: Colorstuk Special Rapid Nacaré



Urban Line Zinc



GLASS / VIDRIO / VERRE

Butech: Colorstuk Special Rapid Dark



Urban Line Copper



GLASS / VIDRIO / VERRE

Butech: Colorstuk Special Rapid Dark

Description	Format	Codes	Group	Pcs	m2	Kg
Urban Line Iron	30x10x0,8 cm	100153506	G-108	30 x Cj	0,90 x Cj	17,67 x Cj
	3 15/16"x1 1 3/4"x3/8"	L244005431		1080 x Pal	32,40 x Pal	636,34 x Pal
Urban Line Lead	30x10x0,8 cm	100153507	G-108	30 x Cj	0,90 x Cj	17,67 x Cj
	3 15/16"x1 1 3/4"x3/8"	L244005421		1080 x Pal	32,40 x Pal	636,34 x Pal
Urban Line Silver	30x10x0,8 cm	100153509	G-108	30 x Cj	0,90 x Cj	17,67 x Cj
	3 15/16"x1 1 3/4"x3/8"	L244005471		1080 x Pal	32,40 x Pal	636,34 x Pal
Urban Line Nickel	30x10x0,8 cm	100153508	G-108	30 x Cj	0,90 x Cj	17,67 x Cj
	3 15/16"x1 1 3/4"x3/8"	L244005461		1080 x Pal	32,40 x Pal	636,34 x Pal
Urban Line Zinc	30x10x0,8 cm	100153510	G-108	30 x Cj	0,90 x Cj	17,67 x Cj
	3 15/16"x1 1 3/4"x3/8"	L244005441		1080 x Pal	32,40 x Pal	636,34 x Pal
Urban Line Copper	30x10x0,8 cm	100153505	G-108	30 x Cj	0,90 x Cj	17,67 x Cj
	3 15/16"x1 1 3/4"x3/8"	L244005451		1080 x Pal	32,40 x Pal	636,34 x Pal

URBAN



Urban Grey



GLASS / VIDRIO / VERRE

Butech: Colorstuk Special Nacaré



Urban Grey Frost



GLASS / VIDRIO / VERRE

Butech: Colorstuk Special Nacaré

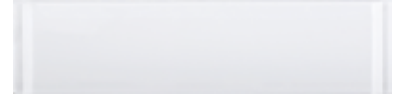

Urban White



GLASS / VIDRIO / VERRE

Butech: Colorstuk Special White



Urban White Frost



GLASS / VIDRIO / VERRE

Butech: Colorstuk Special White



Wall Coverings Urban White Frost

Description	Format	Codes	Group	Pcs	m2	Kg
Urban Grey	7,5x30x0,8 cm 3"x11 3/4"x3/8"	I00102717	G-104	10 x Cj	0,23 x Cj	4,66 x Cj
		L241701951		1920 x Pal	43,20 x Pal	894,72 x Pal
Urban Grey Frost	7,5x30x0,8 cm 3"x11 3/4"x3/8"	I00102718	G-104	10 x Cj	0,23 x Cj	4,66 x Cj
		L241701991		1920 x Pal	43,20 x Pal	894,72 x Pal
Urban White	7,5x30x0,8 cm 3"x11 3/4"x3/8"	I00102719	G-104	10 x Cj	0,23 x Cj	4,66 x Cj
		L241701981		1920 x Pal	43,20 x Pal	894,72 x Pal
Urban White Frost	7,5x30x0,8 cm 3"x11 3/4"x3/8"	I00102720	G-104	10 x Cj	0,23 x Cj	4,66 x Cj
		L241701931		1920 x Pal	43,20 x Pal	894,72 x Pal

URBAN



Urban Retro Iron



GLASS / VIDRIO / VERRE

Butech: Colorstuk Special White



Urban Retro Lead



GLASS / VIDRIO / VERRE

Butech: Colorstuk Special Nacaré



Urban Retro Silver



GLASS / VIDRIO / VERRE

Butech: Colorstuk Special Nacaré



Urban Retro Nickel



GLASS / VIDRIO / VERRE

Butech: Colorstuk Special Nacaré

Description	Format	Codes	Group	Pcs	m2	Kg
Urban Retro Iron	6x24x0,8 cm	100156148	G-104	30 x Cj	0,43 x Cj	8,16 x Cj
	2 3/8" x 9 7/16" x 3/8"	L244005701		1620 x Pal	23,32 x Pal	440,64 x Pal
Urban Retro Lead	6x24x0,8 cm	100156149	G-104	30 x Cj	0,43 x Cj	8,16 x Cj
	2 3/8" x 9 7/16" x 3/8"	L244005711		1620 x Pal	23,32 x Pal	440,64 x Pal
Urban Retro Silver	6x24x0,8 cm	100156171	G-104	30 x Cj	0,43 x Cj	8,16 x Cj
	2 3/8" x 9 7/16" x 3/8"	L244005671		1620 x Pal	23,32 x Pal	440,64 x Pal
Urban Retro Nickel	6x24x0,8 cm	100156170	G-104	30 x Cj	0,43 x Cj	8,16 x Cj
	2 3/8" x 9 7/16" x 3/8"	L244005681		1620 x Pal	23,32 x Pal	440,64 x Pal

URBAN



Wall Coverings Urban Retro Nickel



Wall Coverings Urban Line Copper

INSTALLATION / INSTALACIÓN / INSTALLATION

GLASS MOSAICS

INSTALLATION

INSTALACIÓN

INSTALLATION

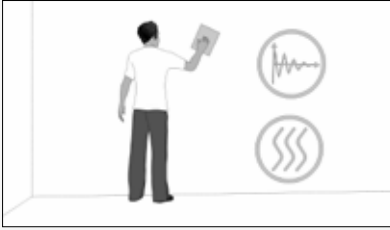

The surface on which the material is going to be installed shall be smooth and consistent. In addition, it shall be dry and clean.

La superficie sobre la que se va a colocar el material debe ser lisa y consistente. además de estar seca y limpia.

La surface où va être posé le matériau doit être lisse, ferme, sèche et propre.

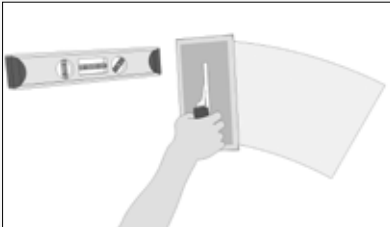

We recommend leveling the surface in order to create a white background.

Se aconseja nivelar la superficie para crear un fondo blanco.

Il est conseillé de mettre à niveau la surface pour créer un fond blanc.

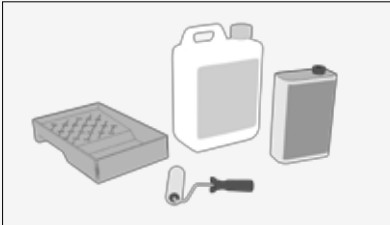

In the case of levels greater than 2 mm, the use of specific products is recommended.

En el caso de nivelados superiores a 2 mm se recomienda el uso de productos específicos.

Si la mise à niveau est supérieure à 2 mm, il est recommandé d'utiliser des produits spécifiques.



In order to maintain the good condition of the leveling product, the room temperature must be between 30 °C and 5 °C.

Para mantener el buen estado del producto de nivelación, la temperatura ambiente debe estar comprendida entre 30° C y 5°C.

Afin de maintenir le produit de nivellement en bon état, la température ambiante doit être entre 30 °C et 5 °C.

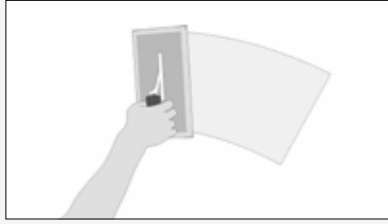

We shall extend the cement-based adhesive with the flat side of a notched trowel evenly on the wall. In our case we recommend Butech's One-flex.

Extendemos el adhesivo cementoso mediante el lado liso de una llana dentada uniformemente sobre el muro. En nuestro caso recomendamos One-flex de Butech

Utiliser le côté lisse d'une taloche crantée pour étendre le mortier colle uniformément sur le mur. Dans notre cas, nous recommandons One-flex de Butech.

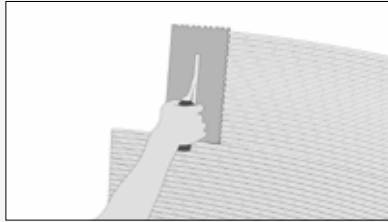

Next, we shall "comb" the adhesive with the notched side (minimum notch 3 mm.) Do not spread the cement-based adhesive over large areas to prevent it from drying before placing the material.

A continuación "peinamos" el adhesivo con el lado dentado (dentadura mínima de 3 mm). no se debe extender el cemento cola en grandes superficies para evitar que se reseque antes de colocar el material.

Puis, "peigner" le mortier colle avec le côté cranté (denture minimale 3 mm). Ne pas étendre le mortier colle sur de trop grandes surfaces pour éviter qu'il ne sèche trop avant de poser le matériau.

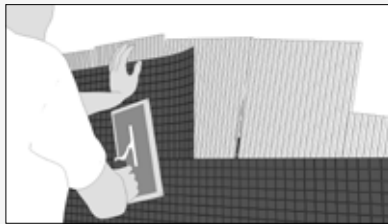

We install sheet and press it evenly with a rubber trowel.

Colocamos la hoja y presionamos uniformemente la misma con una llana de goma.

Mettre en place la feuille puis exercer une légère pression uniforme à l'aide d'une taloche en caoutchouc.

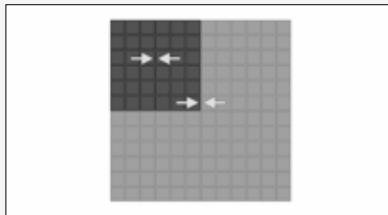

We shall ensure that the distance between the sheets is the same between pieces, resulting in a uniform installation, and that all joints have the same distance to each

other.

Nos aseguramos que la distancia entre hojas sea la misma que hay entre las piezas, resultando a la colocación homogénea y que todas las juntas tengan la misma separación entre sí.

S'assurer que la distance entre les feuilles soit égale à celle existante entre les pièces, afin que la pose soit uniforme et tous les joints soient égaux.

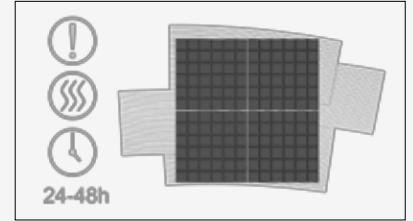

We shall let the adhesive dry for at least 24-48 hours. Before the adhesive sets, debris must be wiped off with a sponge or cloth.

Hay que dejar secar el adhesivo durante al menos 24-48 horas. Antes de que fragüe el adhesivo se deben retirar los restos del mismo con una esponja o un trapo.

Laisser prendre le mortier colle pendant 24-48 heures. Avant le durcissement du mortier-colle, enlever les restes à l'aide d'une éponge ou d'un chiffon.

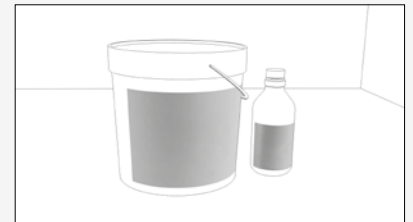

We are ready for grouting.

Ya estamos preparados para el rejuntado.

L'opération suivante est le rejointoiement.

GROUTING (Applicable only for mosaics with joint).

REJUNTADO (aplicable sólo para mosaicos con junta).

REJOINTOIEMENT (Applicable uniquement pour les mosaïques posées avec joint).

All pieces shall be perfectly clean and free of dust before grouting.

Todas las piezas deben estar perfectamente limpias y sin restos de residuos de polvo antes de proceder al rejuntado.

Toutes les pièces devront être propres et libres de poussière avant de rejoiner.

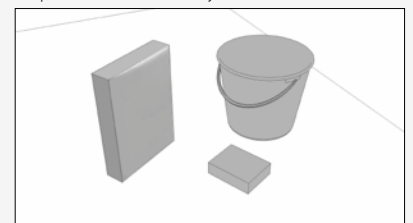

We recommend Butech's colorstuk rapid.

Se recomienda el uso de colorstuk rapid de Butech.

Il est recommandé d'utiliser Colorstuk rapid de Butech.

INSTALLATION / INSTALACIÓN / INSTALLATION

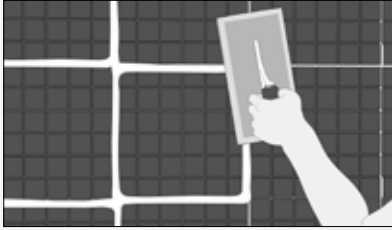

The grouting material is spread with a rubber trowel, filling joints well in all their depth.

Se extiende el material de rejunte con una llana de goma rellenando bien las juntas en toda su profundidad.

Étendre le matériau de rejointoiement à l'aide d'une taloche en caoutchouc en remplissant bien les joints dans toute sa profondeur.

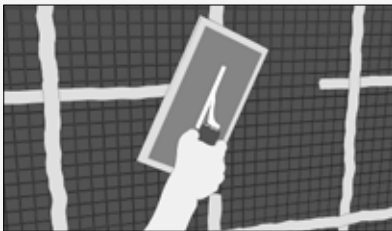

The same trowel shall be used to remove excess grout.

Se utilizará la misma llana para eliminar el exceso.

La même taloche sera utilisée pour enlever l'excès de matériau.

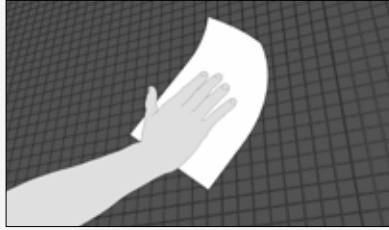

Before the grouting material dries, its remains shall be removed with a sponge or cloth.

Antes de que fragüe el material de rejunte se deben retirar los restos del mismo con una esponja o trapo.

Les restes de matériau utilisé pour le rejointoiement doivent être retirés à l'aide d'une éponge ou d'un chiffon avant qu'il ne prenne.

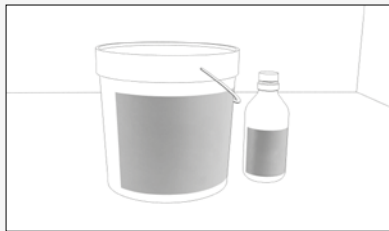

Specifically for areas where the material will be in contact with water (directly or indirectly) the use of Butech's epotech as grout material is recommended.

Específicamente para instalaciones en las que el material vaya a estar en contacto con agua (directa o indirectamente) se recomienda el

uso como material de rejunte de Epotech de Butech.

Pour les installations spécifiques où il est prévu que le matériau soit en contact avec l'eau (directement ou indirectement), il est recommandé d'utiliser le mortier-colle Politech de Butech et le matériau de rejointoiement Epotech de Butech.

You can find the detailed up-to-date installation guide by visiting our website www.anticcolonial.com

Puedes revisar estas instrucciones de instalación actualizadas y con más detalle visitando nuestra página web www.anticcolonial.com

Les dernières mises à jour sur les conseils d'installation et des informations complémentaires sont disponibles sur notre site web www.anticcolonial.com



Wall Coverings Harmony Strip Coltan

INSTALLATION / INSTALACIÓN / INSTALLATION

HEXCUBE MOSAICS

INSTALLATION

INSTALACIÓN

INSTALLATION

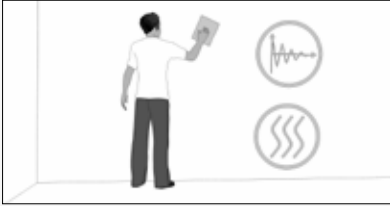

The surface on which the material is going to be installed shall be smooth and consistent. In addition, it shall be dry and clean.

La superficie sobre la que se va a colocar el material debe ser lisa y consistente. además de estar seca y limpia.

La surface où va être posé le matériau doit être lisse, ferme, sèche et propre.



Room temperature must be between 5 °C and 30 °C.

La temperatura ambiente debe estar comprendida entre 5 y 30°C.

La température ambiante doit être entre +5 °C et +30 °C.

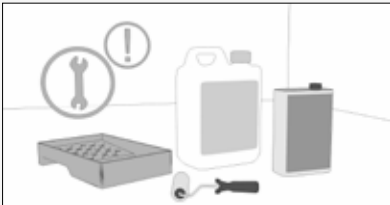

The bonding grip material is prepared following the manufacturer's instructions, and the adhesive shall be applied throughout the installation surface. In our case we recommend Butech's Fr-one.

Se prepara el material de agarre, siguiendo las instrucciones del fabricante, se aplicará el adhesivo por toda la superficie de colocación. En nuestro caso recomendamos Fr-one de Butech.

Préparer ensuite le matériau de fixation en suivant les instructions du fabricant, puis l'appliquer sur la totalité de la surface de pose. Dans notre cas, nous recommandons Fr-one de Butech.

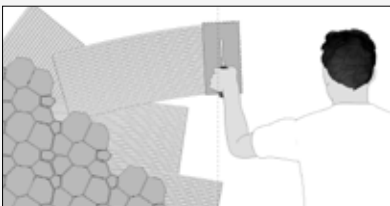

We recommend working in reduced areas in order to prevent it from drying out before installing the material.

Se recomienda trabajar en zonas de extensión reducida para evitar que se reseque antes de colocar el material.

Il est recommandé de travailler par petites zones pour éviter qu'il ne sèche avant de poser le matériau.

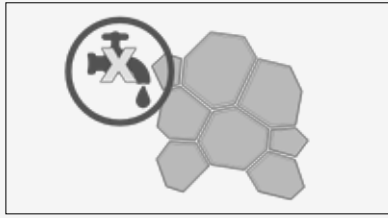

The pieces shall not be wet before installing.

No se deben mojar las piezas antes de colocarlas.

Ne pas mouiller les pièces avant de les poser.

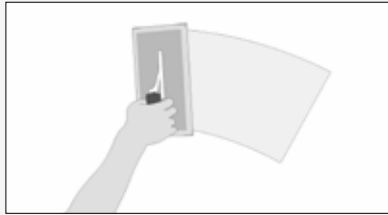

We shall extend the cement-based adhesive with the flat side of a notched trowel evenly on the wall.

Extendemos el adhesivo cementoso mediante el lado liso de una llana dentada uniformemente sobre el muro.

Utiliser le côté lisse d'une taloche crantée pour étendre le mortier colle uniformément sur le mur.

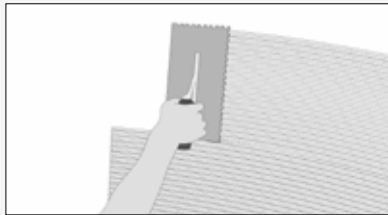

Next, we shall "comb" the adhesive with the notched side (minimum notch 3 mm.)

A continuación "peinamos" el adhesivo con el lado dentado (dentadura mínima de 3 mm).

Puis, "peigner" le mortier colle avec le côté cranté (denture minimale 3 mm).

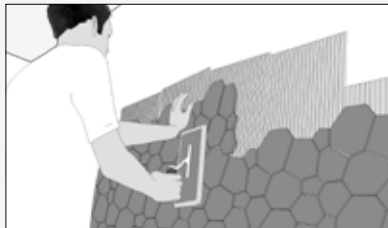

We install the sheet and press it evenly with a rubber trowel.

Colocamos la hoja y presionamos uniformemente la misma con una llana de goma.

Mettre en place la feuille puis exercer une légère pression uniforme à l'aide d'une taloche en caoutchouc.

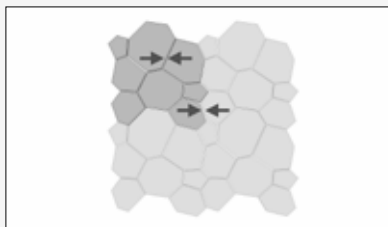

We shall ensure that the distance between the sheets is the same between pieces, resulting in a uniform installation, and that all joints have the same distance to each other.

Nos aseguramos que la distancia entre hojas sea la misma que hay entre las piezas, resultando la colocación homogénea y que todas las juntas tengan la misma separación entre sí.

S'assurer que la distance entre les feuilles soit égale à celle existante entre les pièces, afin que la pose soit uniforme et tous les joints soient égaux.

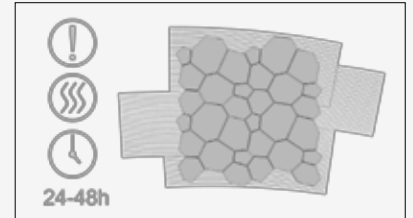

We shall let the adhesive dry for at least 24-48 hours. Before the adhesive sets, debris must be wiped off with a sponge or cloth.

Hay que dejar secar el adhesivo durante al menos 24-48 horas. Antes de que fragüe el adhesivo se deben retirar los restos del mismo con una esponja o un trapo.

Laisser prendre le mortier colle pendant 24-48 heures. Avant le durcissement du mortier-colle, enlever les restes à l'aide d'une éponge ou d'un chiffon.

IMPORTANT CONSIDERATIONS TO BEAR IN MIND

CONSIDERACIONES IMPORTANTES A TENER EN CUENTA

CONSIDÉRATIONS IMPORTANTES À PRENDRE EN COMPTE

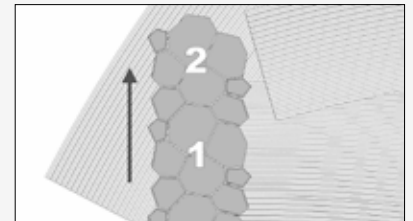

Install the meshes from the bottom up, paying attention to the installation direction of each mesh.

Instalar las mallas de abajo hacia arriba, tomando nota de la dirección de instalación de cada malla.

Disposer les mailles du bas vers le haut, en bien notant dans quelle direction sont installées les mailles.

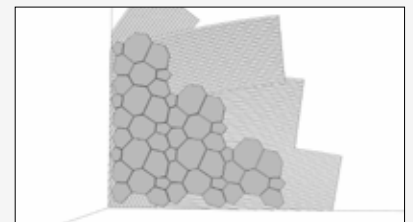

Continue until the entire surface is covered, leaving the corners and the internal angles.

Continuar hasta cubrir toda la superficie dejando las esquinas y los ángulos internos.

Continuer de la même façon jusqu'à couvrir toute la surface, exception faite des coins et des angles internes.

INSTALLATION / INSTALACIÓN / INSTALLATION

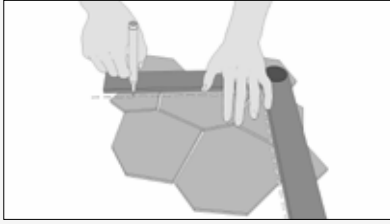

In order to achieve the necessary straight cut for finishing internal angles and corners, mark the straight line on the mesh surface.

Para conseguir el corte recto necesario para acabar los ángulos internos y las esquinas marcar la línea recta en la superficie de la malla.

Pour réaliser la découpe droite requise pour la finition des angles internes et des coins, marquer la ligne droite sur la surface de la maille.

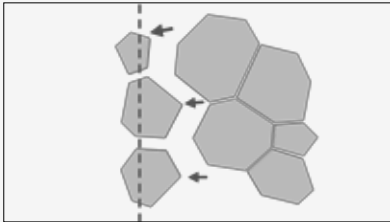

Remove each piece that needs to be cut.

Quitar cada pieza que se tiene que cortar.

Retirer les pièces à couper.

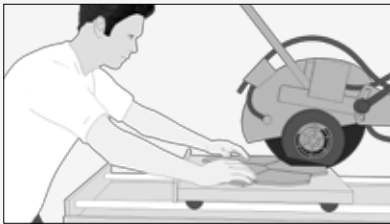

Cut each piece using a diamond water jet cutting saw (do not cut more than two meshes at the same time.)

Cortar cada pieza usando una sierra de diamante al corte de agua (no cortar más de dos mallas a la vez).

Couper chaque pièce à l'aide d'une scie diamant à eau (ne pas couper deux mailles en même temps).

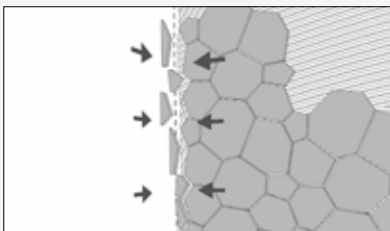

Re-glue the cut pieces to the mesh.

Volver a pegar las piezas cortadas a la malla.

Coller à nouveau les pièces coupées sur la maille.

GROUTING

REJUNTADO

REJOINTOEMENT

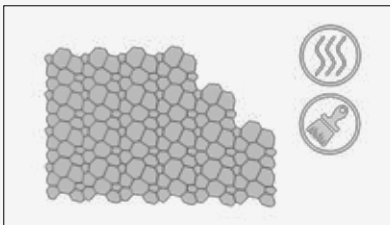

All pieces shall be perfectly clean and free of dust before grouting.

Todas las piezas deben estar perfectamente limpias y sin restos de residuos de polvo antes de proceder al rejuntado.

Toutes les pièces devront être propres et libres de poussière avant de rejointer.

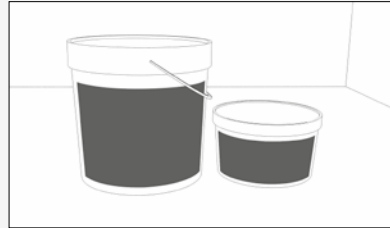

We recommend the use of Epotech aqua.

Se recomienda el uso de Epotech aqua.

Il est recommandé d'utiliser Epotech aqua.

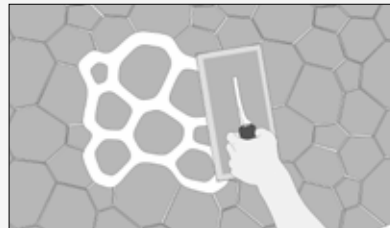

The grouting material is spread with a rubber trowel, filling joints well in all their depth.

Se extiende el material de rejunte con una llana de goma rellenando bien las juntas en toda su profundidad.

Étendre le matériau de rejointoement à l'aide d'une taloche en caoutchouc en remplissant bien les joints dans toute sa profondeur.

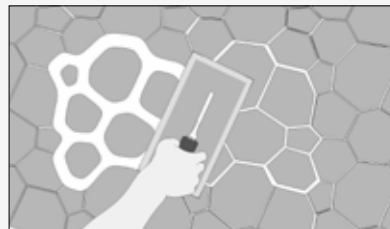

The same trowel shall be used to remove excess grout.

Se utilizará la misma llana para eliminar el exceso.

La même taloche sera utilisée pour enlever l'excès de matériau.



Before the grouting material dries, its remains shall be removed with a sponge or cloth.

Antes de que fragüe el material de rejunte se deben retirar los restos del mismo con una esponja o trapo.

Les restes de matériau utilisé pour le rejointoement doivent être retirés à l'aide d'une éponge ou d'un chiffon avant qu'il ne prenne.

You can find the detailed up-to-date installation guide by visiting our website www.anticcolonial.com

Puedes revisar estas instrucciones de instalación actualizadas y con más detalle visitando nuestra página web www.anticcolonial.com

Les dernières mises à jour sur les conseils d'installation et des informations complémentaires sont disponibles sur notre site web www.anticcolonial.com

INSTALLATION / INSTALACIÓN / INSTALLATION

GLASS TILES

RECEPTION OF MATERIAL

RECEPCIÓN DEL MATERIAL

RÉCEPTION DU MATÉRIAU

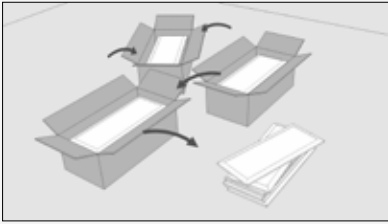

In order to achieve a uniform look, it is very important to mix pieces from different boxes.

Para conseguir un efecto estético homogéneo, es muy importante mezclar piezas de varias cajas diferentes.

Pour un effet esthétique plus homogène, il est important de mélanger des pièces de différents emballages.

INSTALLATION

INSTALACIÓN

INSTALLATION

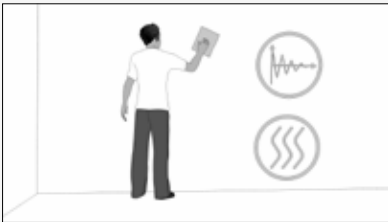

The surface on which the material is going to be installed shall be smooth and consistent. In addition, it shall be dry and clean.

La superficie sobre la que se va a colocar el material debe ser lisa y consistente. Además de estar seca y limpia.

La surface où va être posé le matériau doit être lisse, ferme, sèche et propre.

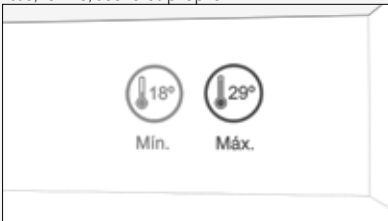

Room temperature must be between 5 °C and 30 °C.

La temperatura ambiente debe estar comprendida entre 5 y 30 °C.

La température ambiante doit être entre +5 °C et +30 °C.

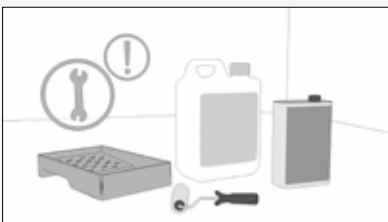

The bonding grip material is prepared following the manufacturer's instructions, and the adhesive shall be applied throughout the installation surface. In our case we recommend Butech's One Flex.

Se prepara el material de agarre, siguiendo las instrucciones del fabricante, se aplicará el adhesivo por toda la superficie de colocación. En nuestro caso recomendamos One Flex de Butech.

Préparer ensuite le matériau de fixation en suivant les instructions du fabricant, puis l'appliquer sur la totalité de la surface de pose. Dans notre cas, nous recommandons One Flex de Butech.

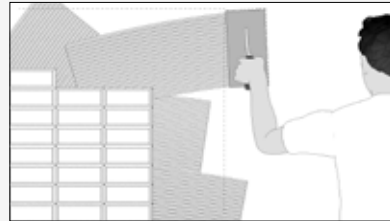

We recommend working in reduced areas in order to prevent it from drying out before installing the material.

Se recomienda trabajar en zonas de extensión reducida para evitar que se reseque antes de colocar el material.

Il est recommandé de travailler par petites zones pour éviter qu'il ne sèche avant de poser le matériau.



The pieces shall not be wet before installing.

No se deben mojar las piezas antes de colocarlas.

Ne pas mouiller les pièces avant de les poser.

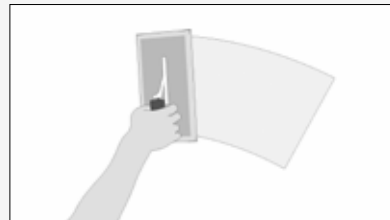

We shall extend the cement-based adhesive with the flat side of a notched trowel evenly on the wall.

Extendemos el adhesivo cementoso mediante el lado liso de una llana dentada uniformemente sobre el muro.

Utiliser le côté lisse d'une taloche crantée pour étendre le mortier colle uniformément sur le mur.

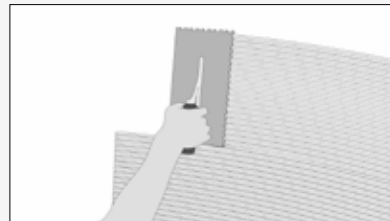

Next, we shall "comb" the adhesive with the notched side (minimum notch 3 mm.)

A continuación "peinamos" el adhesivo con el lado dentado (dentadura mínima de 3 mm).

Puis, "peigner" le mortier colle avec le côté cranté (denture minimale 3 mm).

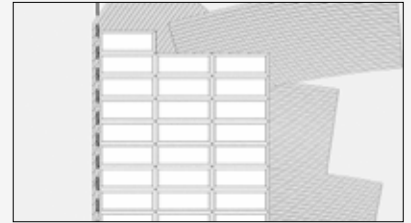

Movement joints shall be marked.

Se deben señalar las juntas de movimiento.

Marquer les joints de mouvement.

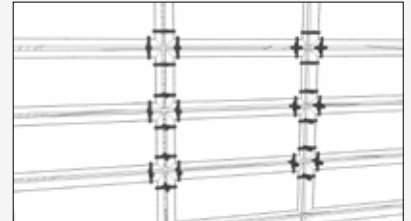

The pieces shall be installed leaving the necessary joint between them, with the assistance of spacers, pressing them and making a small back and forth motion to get the most coverage on their back.

Se colocarán las piezas dejando entre ellas la junta necesaria, con la ayuda de distanciadores, presionándolas y ejerciendo un pequeño movimiento de vaivén para conseguir la mayor cobertura del dorso de las mismas.

Poser les pièces en laissant un espace pour le joint à l'aide d'une cale de distance et en exerçant une légère pression avec un mouvement basculant pour favoriser la bonne distribution du produit au dos de la pièce.



We shall carry out the definitive settling of the pieces using a rigid and clean rubber plate, and beating on it with a rubber mallet.

Se realizará el asentamiento definitivo de las piezas empleando una plancha de goma y limpia, batiendo sobre la misma con un martillo de goma.

Bloquer les pièces dans leur position définitive en les couvrant avec une planche en caoutchouc rigide et propre sur laquelle seront donnés des petits coups secs à l'aide d'un maillet en caoutchouc.

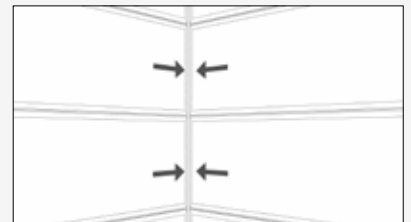

The perimeter joints shall also be taken into account at intersections and level changes.

Deben tenerse en cuenta también juntas perimetrales en los encuentros y cambios de plano.

Prévoir aussi des joints périmétraux aux angles et changements de plan.

INSTALLATION / INSTALACIÓN / INSTALLATION

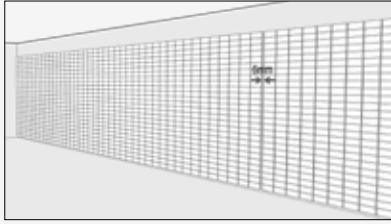

On large surfaces, there shall be intermediate joints at least every 8 m, with joints at least 6 mm wide.

En grandes superficies, deberían disponerse juntas intermedias al menos cada 8 m, teniendo las juntas una anchura mínima de 6 mm.

Pour les grandes surfaces, il faudrait aussi prévoir des joints intermédiaires au moins tous les 8 m. Ces joints devront avoir une largeur minimale de 6 mm.

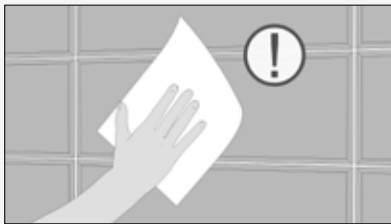

Excess adhesive that accumulates in the joint spaces when installing the pieces shall be cleaned before it hardens.

El exceso de adhesivo que se acumula en los espacios de las juntas al colocar las piezas debe ser limpiado antes de que se endurezca.

L'excès de mortier colle dans les espaces prévus pour les joints lors de la pose des pièces doit être nettoyé avant qu'il ne prenne.

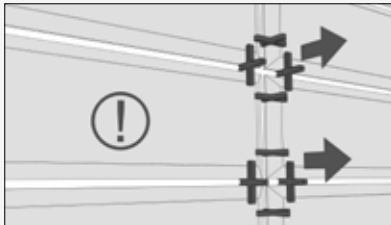

It is important to remove the spacers between pieces before the adhesive hardens.

Es importante retirar los distanciadores entre piezas antes de que se endurezca el adhesivo.

Il est important de retirer les cales de distance entre les pièces avant que le mortier prenne.

GROUTING

REJUNTADO

REJOINTOIEMENT

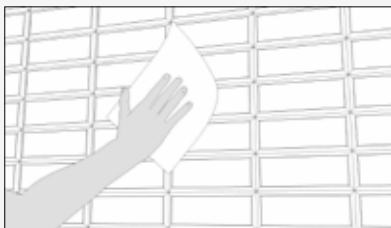

All pieces shall be perfectly clean and free of dust before grouting.

Todas las piezas deben estar perfectamente limpias y sin restos de residuos de polvo antes de proceder al rejuntado.

Le rejointoiement des pièces n'est pas nécessaire après la pose.



We recommend the use of colorstuk rapid.

Se recomienda el uso de colorstuk rapid.

Il est recommandé d'utiliser le produit colorstuk rapid.



The grouting material is spread with a rubber trowel, filling joints well in all their depth.

Se extiende el material de rejunte con una llana de goma rellenando bien las juntas en toda su profundidad.

Étendre le matériau de rejointoiement à l'aide d'une taloche en caoutchouc en remplissant bien les joints dans toute sa profondeur.



The same trowel shall be used to remove excess grout.

Se utilizará la misma llana para eliminar el exceso.

La même taloche sera utilisée pour enlever l'excès de matériau.



Before the grouting material dries, its remains shall be removed with a sponge or cloth.

Antes de que fragüe el material de rejunte se deben retirar los restos del mismo con una esponja o trapo.

Les restes de matériau utilisé pour le rejointoiement doivent être retirés à l'aide d'une éponge ou d'un chiffon avant qu'il ne prenne.



Specifically for areas where the material will be in contact with water (directly or

indirectly) the use of Butech's epotech as grout material is recommended.

Específicamente para instalaciones en las que el material vaya a estar en contacto con agua (directa o indirectamente) se recomienda el uso como material de rejunte de Epotech de Butech.

Pour les installations spécifiques où il est prévu que le matériau soit en contact avec l'eau (directement ou indirectement), il est recommandé d'utiliser le matériau de rejointoiement Epotech de Butech.

CUTTING AND DRILLING

CORTE Y PERFORACIÓN

COUPE ET PERCEMENT

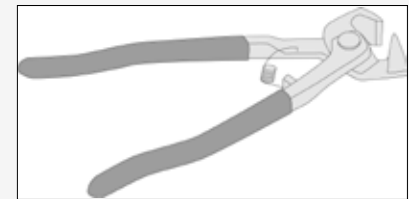

For small cuts and blunting, we recommend the BUTECH pliers for glass.

Para cortes pequeños y despuntados se recomienda las tenazas BUTECH para vidrio.

Pour les coupes de petite taille et les émoussements, l'utilisation de tenailles BUTECH spéciales pour pièces en verre est conseillée.

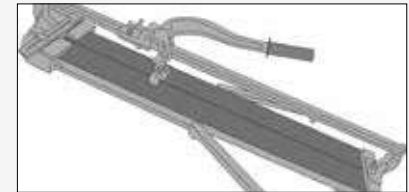

Dry cuts are carried out with the SIGMA machine.

Los cortes en seco se realizan con la máquina SIGMA.

Les coupes à sec se feront toujours avec la machine SIGMA.



Cuts in full pieces shall be carried out with a BUTECH water-cooled cutting machine with diamond disk.

Los cortes en piezas enteras se realizarán con una máquina de corte con disco de diamante BUTECH refrigerada por agua.

Les coupes de pièces complètes se feront toujours avec une machine de coupe équipée d'un disque diamant BUTECH refroidies à l'eau.

You can find the detailed up-to-date installation guide by visiting our website www.anticcolonial.com

Puedes revisar estas instrucciones de instalación actualizadas y con más detalle visitando nuestra página web www.anticcolonial.com

Les dernières mises à jour sur les conseils d'installation et des informations complémentaires sont disponibles sur notre site web www.anticcolonial.com



Wall Coverings Eternity Mini Strip Cream

MIX MOSAICS

.....

Imperia
Diverse
Tribal
Tecno
Eternity
Treasures
Fusion
Aura
Time
Renaissance
Trend
Frame
Elements
Art

IMPERIA



Imperia Mix Silver Greys
1,5x1,5cm - 5/8"x5/8"



ENAMELED TRAVERTINE / TRAVERTINO ESMALTADO /
TRAVERTIN ÉMAILLÉ
GLASS / VIDRIO / VERRE

Butech: Colorstuk Rapid Blanco



Imperia Mix Silver White
1,5x1,5cm - 5/8"x5/8"

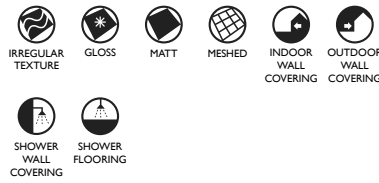

MARBLE / MÁRMOL / MARBRE
GLASS / VIDRIO / VERRE

Butech: Colorstuk Rapid Blanco



Imperia Onix Golden
1,5x1,5cm - 5/8"x5/8"



ENAMELED TRAVERTINE / TRAVERTINO ESMALTADO /
TRAVERTIN ÉMAILLÉ
ONIX / ONIX / ONIX

Butech: Colorstuk Rapid Marfil



Imperia White
1,5x1,5cm - 5/8"x5/8"

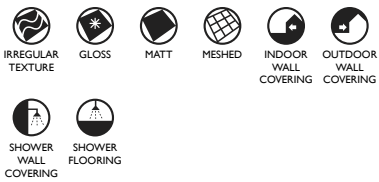

MARBLE / MÁRMOL / MARBRE
GLASS / VIDRIO / VERRE

Butech: Colorstuk Rapid Blanco



Imperia Nepal Bronze
1,5x1,5cm - 5/8"x5/8"

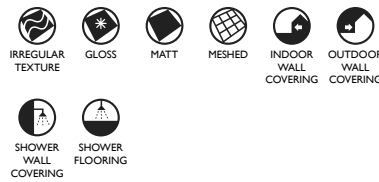

SLATE / PIZARRA / ARDOISE
GLASS / VIDRIO / VERRE

Butech: Colorstuk Rapid Antracita

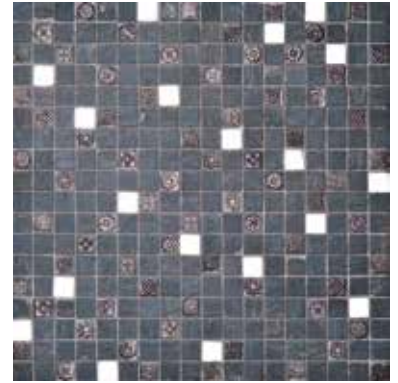

Imperia Bhutan Mirror
1,5x1,5cm - 5/8"x5/8"

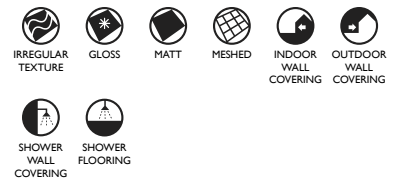

SLATE / PIZARRA / ARDOISE
GLASS / VIDRIO / VERRE

Butech: Colorstuk Rapid Antracita

Description	Format	Codes	Group	Pcs	m2	Kg
Imperia Mix Silver Greys (1,5)	30,1x30,1x0,8 cm	100092752	G-126	11 x Cj	0,99 x Cj	15,10 x Cj
	11 3/4"x11 3/4"x3/8"	L244000571		594 x Pal	53,82 x Pal	815,56 x Pal
Imperia Mix Silver White (1,5)	29,8x29,8x0,8 cm	100097070	G-126	11 x Cj	0,99 x Cj	17,08 x Cj
	11 3/4"x11 3/4"x3/8"	L242521601		594 x Pal	52,75 x Pal	922,48 x Pal
Imperia Onix Golden (1,5)	30x30x0,8 cm	100092753	G-118	11 x Cj	0,99 x Cj	15,59 x Cj
	11 3/4"x11 3/4"x3/8"	L150901201		594 x Pal	53,46 x Pal	842 x Pal
Imperia White (1,5)	30x30x0,8 cm	100092754	G-125	11 x Cj	0,99 x Cj	15,72 x Cj
	11 3/4"x11 3/4"x3/8"	L242521481		594 x Pal	53,46 x Pal	849 x Pal
Imperia Nepal Bronze (1,5)	30x30x0,8 cm	100092757	G-118	11 x Cj	0,99 x Cj	16,44 x Cj
	11 3/4"x11 3/4"x3/8"	L108012981		594 x Pal	53,46 x Pal	888 x Pal
Imperia Bhutan Mirror (1,5)	30x30x0,8 cm	100092747	G-118	11 x Cj	0,99 x Cj	15,85 x Cj
	11 3/4"x11 3/4"x3/8"	L108012951		594 x Pal	53,46 x Pal	856 x Pal

IMPERIA

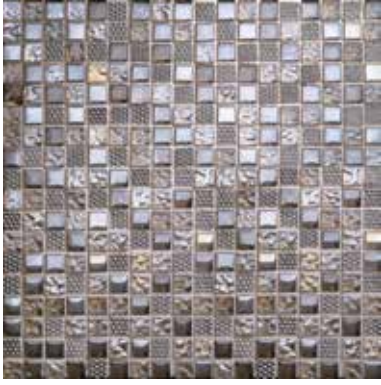

Imperia Caramel
1,5x1,5cm - 5/8"x5/8"

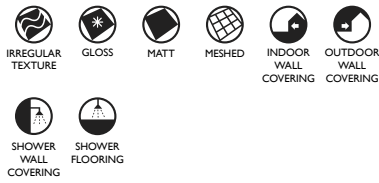

ENAMELED CERAMIC / CERÁMICA ESMALTADA /
CÉRAMIQUE ÉMAILLÉ
GLASS / VIDRIO / VERRE

Butech: Colorstuk Rapid Marfil

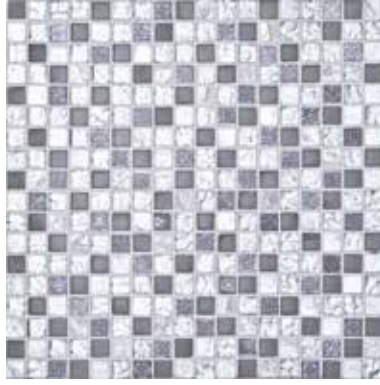

Imperia Greys
1,5x1,5cm - 5/8"x5/8"



ENAMELED SLATE / PIZARRA ESMALTADA / ARDOISE
ÉMAILLÉ
GLASS / VIDRIO / VERRE

Butech: Colorstuk Rapid Blanco

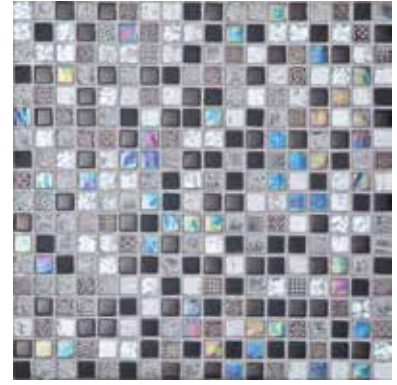

Imperia Mix Silver Blacks
1,5x1,5cm - 5/8"x5/8"



ENAMELED TRAVERTINE / TRAVERTINO ESMALTADO /
TRAVERTIN ÉMAILLÉ
GLASS / VIDRIO / VERRE

Butech: Colorstuk Rapid Marfil



Imperia Mix Silver Blue Blacks
1,5x1,5cm - 5/8"x5/8"

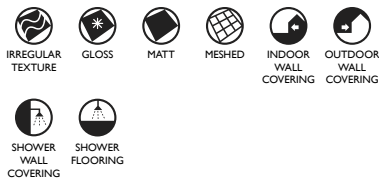

SLATE / PIZARRA / ARDOISE
GLASS / VIDRIO / VERRE

Butech: Colorstuk Rapid Antracita



Wall Coverings Imperia Mix Silver Blue Blacks

Description	Format	Codes	Group	Pcs	m2	Kg
Imperia Caramel (1,5)	30x30x0,8 cm	100092749	G-125	11 x Cj	0,99 x Cj	15,43 x Cj
	11 3/4"x11 3/4"x3/8"	L242521501		594 x Pal	53,46 x Pal	833 x Pal
Imperia Greys (1,5)	30x30x0,8 cm	100092750	G-125	11 x Cj	0,99 x Cj	15,74 x Cj
	11 3/4"x11 3/4"x3/8"	L242521471		594 x Pal	53,46 x Pal	850 x Pal
Imperia Mix Silver Blacks (1,5)	30,1x30,1x0,8 cm	100092751	G-126	11 x Cj	0,99 x Cj	15,72 x Cj
	11 3/4"x11 3/4"x3/8"	L244000561		594 x Pal	53,82 x Pal	849 x Pal
Imperia Mix Silver Blue Blacks (1,5)	29,8x29,8x0,8 cm	100097069	G-126	11 x Cj	0,98 x Cj	17,08 x Cj
	11 3/4"x11 3/4"x3/8"	L242521611		594 x Pal	52,75 x Pal	922,48 x Pal

DIVERSE

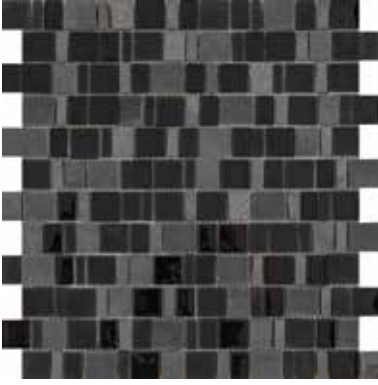

Diverse Black

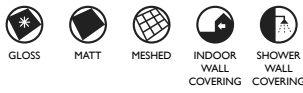

GRANITE / GRANITO / GRANITE
 CERAMIC / CERÁMICA / CÉRAMIQUE
 ENAMEL / ESMALTE / GLAZE

Butech: Colorstuk Rapid Negro



Diverse Grey

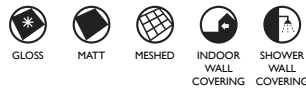

GRANITE / GRANITO / GRANITE
 GLASS / VIDRIO / VERRE

Butech: Colorstuk Rapid Gris



Diverse White

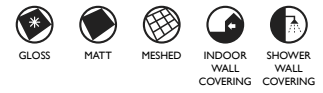

MARBLE / MÁRMOL / MARBRE
 GLASS / VIDRIO / VERRE

Butech: Colorstuk Rapid Blanco



Wall Coverings Diverse Grey

Description	Format	Codes	Group	Pcs	m2	Kg
Diverse Black	30x28,5x0,8 cm	100171113	G-133	11 x Cj	0,94 x Cj	17,08 x Cj
	11 3/8"x11 1/4"x3/8"	L244007051		528 x Pal	45,14 x Pal	819,98 x Pal
Diverse Grey	30x28,5x0,8 cm	100171114	G-133	11 x Cj	0,94 x Cj	17,08 x Cj
	11 3/8"x11 1/4"x3/8"	L244007041		528 x Pal	45,14 x Pal	819,98 x Pal
Diverse White	30x28,5x0,8 cm	100171079	G-133	11 x Cj	0,94 x Cj	17,08 x Cj
	11 3/8"x11 1/4"x3/8"	L244007031		528 x Pal	45,14 x Pal	819,98 x Pal

TRIBAL



Tribal Pearl Black
1x2 cm - 3/8"x3/4"

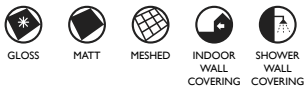

GLASS / VIDRIO / VERRE
MOTHER OF PEARL / MADREPERLA / NACRE
MARBLE / MÁRMOL / MARBRE

Butech: Colorstuk Rapid Antracita



Tribal Pearl Brown
1x2 cm - 3/8"x3/4"

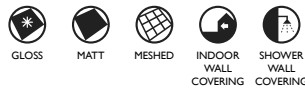

GLASS / VIDRIO / VERRE
MOTHER OF PEARL / MADREPERLA / NACRE
MARBLE / MÁRMOL / MARBRE

Butech: Colorstuk Special Moka



Tribal Pearl White
1x2 cm - 3/8"x3/4"

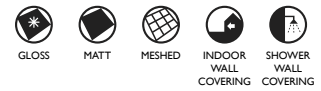

GLASS / VIDRIO / VERRE
MOTHER OF PEARL / MADREPERLA / NACRE
MARBLE / MÁRMOL / MARBRE

Butech: Colorstuk Special Nacaré



Wall Coverings Tribal Pearl Brown

Description	Format	Codes	Group	Pcs	m2	Kg
Tribal Pearl Black (1x2)	28,6x28,3x0,8 cm 11 1/4"x11 1/8"x3/8"	100112135 L244001091	G-136	12 x Cj 576 x Pal	0,97 x Cj 46,62 x Pal	13,66 x Cj 655,49 x Pal
Tribal Pearl Brown (1x2)	28,6x28,3x0,8 cm 11 1/4"x11 1/8"x3/8"	100112136 L244001141	G-136	12 x Cj 576 x Pal	0,97 x Cj 46,62 x Pal	13,66 x Cj 655,49 x Pal
Tribal Pearl White (1x2)	28,6x28,3x0,8 cm 11 1/4"x11 1/8"x3/8"	100112137 L244001101	G-139	12 x Cj 576 x Pal	0,97 x Cj 46,62 x Pal	13,66 x Cj 655,49 x Pal



TECNO

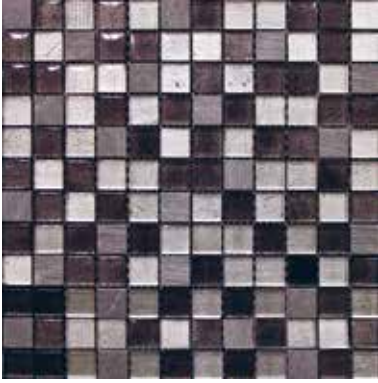

Tecno Bhutan Silver Glass
2,3x2,3cm - 7/8"x7/8"

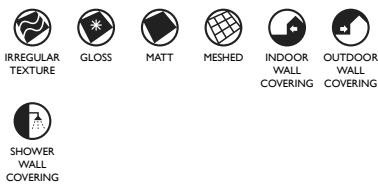

GLASS / VIDRIO / VERRE
SLATE / PIZARRA / ARDOISE

Butech: Colorstuk Rapid Antracita



Tecno Nepal Golden Glass
2,3x2,3cm - 7/8"x7/8"

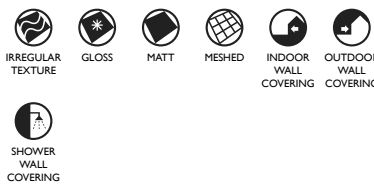

GLASS / VIDRIO / VERRE
SLATE / PIZARRA / ARDOISE

Butech: Colorstuk Rapid Bahama



Tecno Linear Silver White

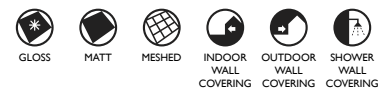

GLASS / VIDRIO / VERRE
QUARTZITE / CUARCITA / QUARTZITE

Butech: Colorstuk Rapid Blanco



Tecno Br. Bhutan Silver Glass
2,3x7,3cm - 7/8"x2 7/8"

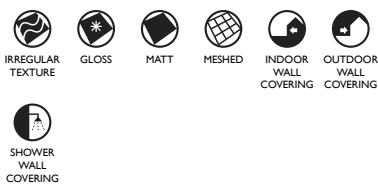

GLASS / VIDRIO / VERRE
SLATE / PIZARRA / ARDOISE

Butech: Colorstuk Rapid Antracita



Tecno Br. Nepal Golden Glass
2,3x7,3cm - 7/8"x2 7/8"

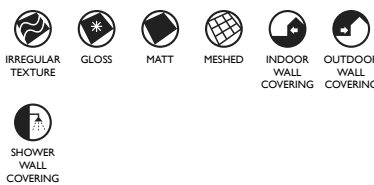

GLASS / VIDRIO / VERRE
SLATE / PIZARRA / ARDOISE

Butech: Colorstuk Rapid Bahama



Tecno Nepal Decor
2,3x2,3cm - 7/8"x7/8"

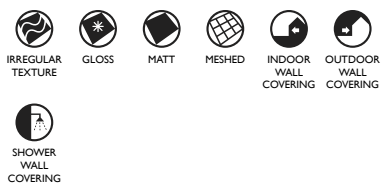

SLATE / PIZARRA / ARDOISE

Butech: Colorstuk Rapid Gris

Description	Format	Codes	Group	Pcs	m2	Kg
Tecno Bhutan Silver Glass (2,3)	30x30x0,8 cm	100092759	G-126	11 x Cj	0,99 x Cj	17,04 x Cj
	11 3/4"x11 3/4"x3/8"	L242521531		594 x Pal	53,46 x Pal	920 x Pal
Tecno Nepal Golden Glass (2,3)	30x30x0,8 cm	100092762	G-126	11 x Cj	0,99 x Cj	17,07 x Cj
	11 3/4"x11 3/4"x3/8"	L242521521		594 x Pal	53,46 x Pal	922 x Pal
Tecno Linear Silver White	29,8x30,5x0,8 cm	100097088	G-125	11 x Cj	1 x Cj	17,38 x Cj
	12"x11 3/4"x3/8"	L242521831		594 x Pal	53,99 x Pal	938,52 x Pal
Tecno Br. Bhutan Silver Glass (2,3x7,3)	30x30x0,8 cm	100092760	G-125	11 x Cj	0,87 x Cj	15,91 x Cj
	11 3/4"x11 3/4"x3/8"	L242521511		594 x Pal	46,78 x Pal	859 x Pal
Tecno Br. Nepal Golden Glass (2,3x7,3)	30x30x0,8 cm	100092761	G-125	11 x Cj	0,87 x Cj	15,96 x Cj
	11 3/4"x11 3/4"x3/8"	L242521541		594 x Pal	46,78 x Pal	862 x Pal
Tecno Nepal Decor (2,3)	29,8x29,8x0,8 cm	100088511	G-125	11 x Cj	0,99 x Cj	14,06 x Cj
	11 3/4"x11 3/4"x3/8"	L108010901		594 x Pal	53,46 x Pal	759,13 x Pal

TECNO

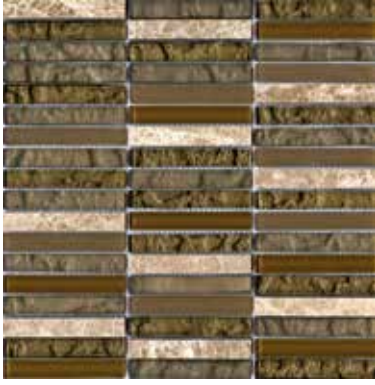

Tecno Linear Brown Capuccino



GLASS / VIDRIO / VERRE
MARBLE / MÁRMOL / MARBRE

Butech: Colorstuk Rapid Marfil



Tecno Linear Cream Capuccino



GLASS / VIDRIO / VERRE
MARBLE / MÁRMOL / MARBRE

Butech: Colorstuk Rapid Marfil

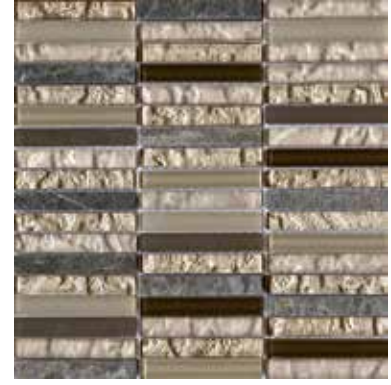

Tecno Linear Cream Habana



GLASS / VIDRIO / VERRE
MARBLE / MÁRMOL / MARBRE

Butech: Colorstuk Rapid Marfil



Tecno Glass Country
2,1x2,1cm - 7/8"x7/8"



GLASS / VIDRIO / VERRE
ENAMELED SLATE / PIZARRA ESMALTADA / ARDOISE ÉMAILLÉ

Butech: Colorstuk Rapid Beige



Tecno Quarz Emerald
2,1x2,1cm - 7/8"x7/8"



GLASS / VIDRIO / VERRE
QUARTZITE / CUARCITA / QUARTZITE

Butech: Colorstuk Rapid Blanco



Tecno Quarz Mountain
2,1x2,1cm - 7/8"x7/8"



GLASS / VIDRIO / VERRE
QUARTZITE / CUARCITA / QUARTZITE

Butech: Colorstuk Rapid Blanco

Description	Format	Codes	Group	Pcs	m2	Kg
Tecno Linear Brown Capuccino	29,8x30,5x0,8 cm 12"x11 3/4"x3/8"	100097086 L242521861	G-125	11 x Cj 594 x Pal	1 x Cj 53,99 x Pal	17,38 x Cj 938,52 x Pal
Tecno Linear Cream Capuccino	29,8x30,5x0,8 cm 12"x11 3/4"x3/8"	100097090 L242521841	G-125	11 x Cj 594 x Pal	1 x Cj 53,99 x Pal	17,38 x Cj 938,52 x Pal
Tecno Linear Cream Habana	29,8x30,5x0,8 cm 12"x11 3/4"x3/8"	100097087 L242521851	G-125	11 x Cj 594 x Pal	1 x Cj 53,99 x Pal	17,38 x Cj 938,52 x Pal
Tecno Glass Country (2,1)	29,6x29,6x0,8 cm 11 5/8"x 11 5/8"x3/8"	100097093 L242521741	G-125	11 x Cj 594 x Pal	0,96 x Cj 52,04 x Pal	16,25 x Cj 877,34 x Pal
Tecno Quarz Emerald (2,1)	29,6x29,6x0,8 cm 11 5/8"x 11 5/8"x3/8"	100097095 L242521731	G-133	11 x Cj 594 x Pal	0,96 x Cj 52,04 x Pal	16,25 x Cj 877,34 x Pal
Tecno Quarz Mountain (2,1)	29,6x29,6x0,8 cm 11 5/8"x 11 5/8"x3/8"	100097089 L242521691	G-125	11 x Cj 594 x Pal	0,96 x Cj 52,04 x Pal	16,25 x Cj 877,34 x Pal

ETERNITY



Eternity Cream
1,5x1,5cm - 5/8"x5/8"

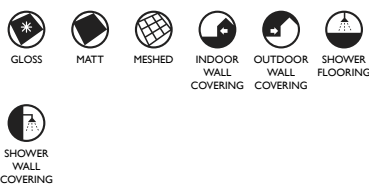

GLASS / VIDRIO / VERRE
MARBLE / MÁRMOL / MARBRE

Butech: Colorstuk Rapid Marfil

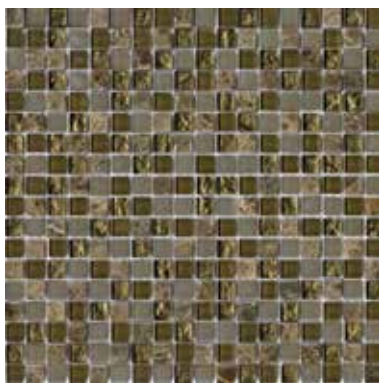

Eternity Emperador
1,5x1,5cm - 5/8"x5/8"

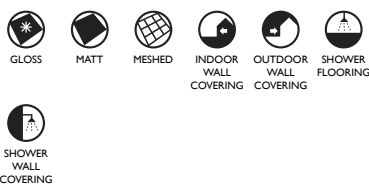

GLASS / VIDRIO / VERRE
MARBLE / MÁRMOL / MARBRE

Butech: Colorstuk Rapid Marfil

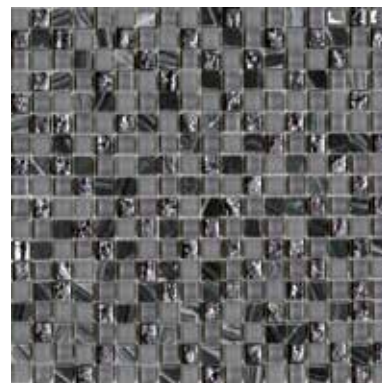

Eternity Grey
1,5x1,5cm - 5/8"x5/8"



GLASS / VIDRIO / VERRE
MARBLE / MÁRMOL / MARBRE

Butech: Colorstuk Rapid Gris



Eternity Mini Strip Cream



GLASS / VIDRIO / VERRE
MARBLE / MÁRMOL / MARBRE

Butech: Colorstuk Rapid Marfil



Eternity Mini Strip Emperador

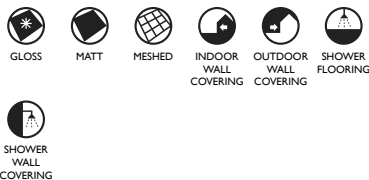

GLASS / VIDRIO / VERRE
MARBLE / MÁRMOL / MARBRE

Butech: Colorstuk Rapid Marfil



Eternity Mini Strip Grey



GLASS / VIDRIO / VERRE
MARBLE / MÁRMOL / MARBRE

Butech: Colorstuk Rapid Gris

Description	Format	Codes	Group	Pcs	m2	Kg
Eternity Cream (1,5)	29,7x29,7x0,8 cm	100097100	G-134	10 x Cj	0,88 x Cj	15,01 x Cj
	11 3/4"x 11 3/4"x3/8"	L242521791		600 x Pal	52,92 x Pal	900,60 x Pal
Eternity Emperador (1,5)	29,7x29,7x0,8 cm	100097101	G-134	10 x Cj	0,88 x Cj	15,01 x Cj
	11 3/4"x 11 3/4"x3/8"	L242521811		600 x Pal	52,92 x Pal	900,60 x Pal
Eternity Grey (1,5)	29,7x29,7x0,8 cm	100097102	G-134	10 x Cj	0,88 x Cj	15,01 x Cj
	11 3/4"x 11 3/4"x3/8"	L242521771		600 x Pal	52,92 x Pal	900,60 x Pal
Eternity Mini Strip Cream	29,8x30,5x0,8 cm	100097103	G-134	5 x Cj	0,44 x Cj	8,02 x Cj
	11 3/4"x 11 3/4"x3/8"	L242521821		360 x Pal	31,75 x Pal	577,44 x Pal
Eternity Mini Strip Emperador	29,8x30,5x0,8	100097104	G-134	5 x Cj	0,44 x Cj	8,02 x Cj
	11 3/4"x 11 3/4"x3/8"	L242521751		360 x Pal	31,75 x Pal	577,44 x Pal
Eternity Mini Strip Grey	29,8x30,5x0,8	100097105	G-134	5 x Cj	0,44 x Cj	8,02 x Cj
	11 3/4"x 11 3/4"x3/8"	L242521801		360 x Pal	31,75 x Pal	577,44 x Pal

STOCK 2017

STOCK 2017

STOCK 2017