

FRANKE



COLECCIÓN
2023

Una gran actuación merece un gran escenario



THE SHOW IS HOME

FRANKE

Cubetas

Fregaderos

Grifos

Campanas

Electrodomésticos

Gestión de residuos

Accesorios



Cubetas

Fregaderos

Grifos

Campanas

Electrodomésticos

Gestión de residuos

Accesorios

COLECCIÓN 2023

FAMILIAS

12	Mythos
18	Maris
22	Smart

CATEGORÍAS DE PRODUCTO

	Cubetas
28	Acero Inoxidable
58	Fraceram
64	Fragranite
82	Tectonite
88	Solid Surface
	Fregaderos
94	Acero Inoxidable
110	Fragranite
118	Tectonite
	Grifos
128	Agua Filtrada
136	Semiprofesionales
144	Tendencia diseño
	Campanas
188	Air Hub
194	Campanas
214	Placas con campana
	Electrodomésticos
262	Hornos y microondas
278	Placas
296	Lavavajillas
300	Frigoríficos
312	Gestión de Residuos
322	Accesorios

Cubetas

Fregaderos

Grifos

Campanas

Electrodomésticos

Gestión de residuos

Accesorios

Más de cien años de pasión

Fundada en 1911, Franke nació sobre una base de ingeniería de precisión combinada con la artesanía tradicional. Más de 100 años después, esos principios perduran. Poner atención a las necesidades cambiantes del mercado y los diferentes estilos de vida de nuestros clientes nos ha ayudado a convertirnos en el mayor fabricante de fregaderos de cocina del mundo.



Ingeniería de precisión suiza

Franke comenzó como una pequeña empresa metalúrgica en Rorschach, Suiza, fundada por Hermann Franke en 1911. Desde entonces, hemos crecido con fábricas de producción por todo el mundo.

Muchas cosas han cambiado en el último siglo, pero lo que importa son los valores, que se caracterizan por el respeto, la confianza y la sinceridad. Los valores de la innovación, el espíritu empresarial, la calidad y el diseño elegante estaban en el corazón de Hermann Franke y continúan estando en el espíritu del negocio.



Cubetas

Fregaderos

Grifos

Campanas

Electrodomésticos

Gestión de residuos

Accesorios

“ Creemos que la sostenibilidad significa justicia para las generaciones futuras ”

Dando forma a nuestro futuro

Cuidar el medio ambiente, dar forma al futuro.

Como empresa consciente de nuestras responsabilidades, pensamos y actuamos hoy a favor del mundo del mañana. Trabajamos de la mano con nuestros empleados, clientes y proveedores para crear un futuro mejor donde las personas puedan prosperar.

“Creemos que la sostenibilidad significa justicia para las generaciones futuras” – esta cita de Michael Pieper, propietario de Franke Group, resume los ideales de nuestra empresa. Conciliamos la economía y la ecología y hacemos una contribución proactiva al desarrollo sostenible, con productos duraderos, materiales reciclables y tecnologías inteligentes. Utilizamos los objetivos globales de desarrollo sostenible y el Pacto Mundial de las Naciones Unidas (UNGC) como guía y marco en el camino hacia un futuro climáticamente neutro.

Poner a las personas en el centro de nuestra sostenibilidad

La base de nuestra nueva estrategia de sostenibilidad se basa en los tres pilares; el medio ambiente, los empleados y la empresa. En lo que respecta al medio ambiente, nos centramos en la producción y los ciclos de vida de nuestros productos. Como líder

del mercado, la creación de soluciones integrales e innovadoras con un valor añadido real es tanto un desafío como una fuente de motivación.

Nuestros orígenes suizos están presentes en cada uno de nuestros productos para recordarnos el deber de mantener unos estándares de excelencia, durabilidad y calidad.

También sentimos una inmensa responsabilidad hacia nuestros empleados más de 8.000 alrededor de todo el mundo. Palabras como reconocimiento y confianza, están profundamente arraigadas en el ADN de nuestra empresa.

Ayudamos a las personas a mantenerse saludables y a hacer realidad sus aspiraciones profesionales. Franke es sinónimo de diversidad, igualdad de oportunidades, conexión y una cultura de empresa donde las personas puedan dar lo mejor de sí mismas aportando sus propias ideas.

¡Bueno para todos!

Bueno para nuestros empleados y clientes, bueno para el planeta, bueno para desarrollar nuestro trabajo.

Creemos que la sostenibilidad significa planificar y anticiparse.

Vemos la acción medioambiental como una oportunidad y esta actitud también se refleja en los productos de Franke.



Menos plástico y mejor sabor

Sin envases ni desperdicios. Beber agua potable del grifo conlleva menos recursos ambientales que el agua mineral o con gas. Las botellas de plástico tienen un efecto particularmente severo en el medio ambiente: en todo el mundo, más de 1.500 botellas terminan en el mar cada segundo. No tiene por qué ser así. Con nuestro grifo con filtro Vital, puedes transformar el agua del grifo en deliciosa agua para beber. El filtro más pequeño del mundo combina el carbón activo con una membrana biológica que permite eliminar impurezas orgánicas (bacterias, virus, microplásticos, óxido, residuos de medicamentos, óxido, hormonas...) garantizando un agua potable que mantiene todos los minerales saludables para el organismo, buena para la salud y el medio ambiente.

Ahorrar agua nunca ha sido tan fácil

Otra estrella en la gama de productos de Franke es el Atlas Neo Sensor. Esta innovadora tecnología de grifería electrónica con sensor automático te permite apagar y volver a encender el flujo de agua incluso cuando tus manos están cubiertas de jabón, evitando el uso manual de las asas.

Ahorrarás alrededor de tres litros de agua cada vez que te laves las manos y mantendrás el grifo impecable. El sensor se apagará automáticamente después de 30 segundos. No hace falta decir que también se puede usar como grifo manual.



Aire limpio para una máxima eficiencia energética

Nuestras placas de inducción con campana integrada ofrecen la máxima eficiencia energética. El modelo Mythos 2gether, gracias a su motor innovador de gran capacidad de aspiración, está catalogado con la mejor calificación de eficiencia energética posible, la A+++.

Cubetas

Fregaderos

Grifos

Campanas

Electrodomésticos

Gestión de residuos

Accesorios

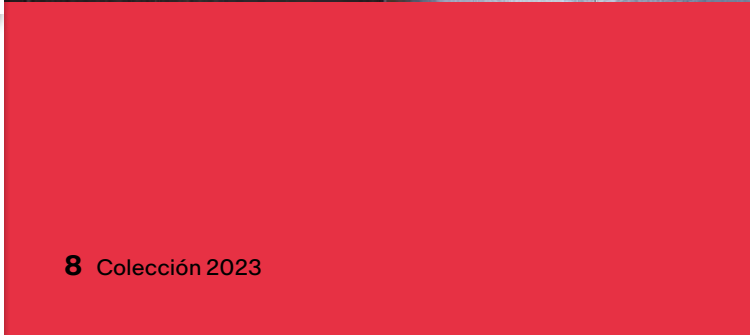

FRANKE

HOME SOLUTIONS

Soluciones que van de la mano

Nuestras cocinas son lugares para vivir: allí cocinamos, comemos, pasamos tiempo juntos, todo al mismo tiempo. Hemos observado a fondo los usos que hacemos en nuestras cocinas y desarrollamos soluciones domésticas adecuadas en lugar de simples aparatos. Todos nuestros productos individuales se fusionan en sistemas funcionales destinados a hacer más fácil tu día a día y a alegrar tu vista gracias a la perfecta combinación de colores, diseños y combinaciones. Cuando todo se une, es más fácil disfrutar de cada momento.

Zona de preparación de alimentos

Grifos, fregaderos y gestión de residuos.

Grifos galardonados, inteligentes y respetuosos con el medio ambiente que se complementan perfectamente con elegantes y amplias cubetas que pueden equiparse con accesorios u otros utensilios inteligentes para que tengas todo lo que necesitas, siempre a mano. Todo en los mejores materiales, más duraderos e higiénicos, como el acero inoxidable o nuestro exclusivo Fragranite.



Campanas extractoras

Campanas de pared, de techo, integradas, de isla.

Cada cocina tiene unas necesidades específicas, por eso hemos creado una gama de campanas capaces de sorprenderte con tecnología, eficiencia, iluminación y hermosos diseños. Descubre los colores, formas y tecnologías especiales disponibles desde pantallas incorporadas hasta sistemas de purificación del aire.

Electrodomésticos

Hornos, microondas, placas de cocción, frigoríficos, lavavajillas y calienta platos.

Cuando diseñamos nuestros electrodomésticos, lo hacemos pensando en tus rutinas para poder ofrecer soluciones funcionales que sean fáciles de usar, inteligentes en sus características y atractivas a la vista.



Inspi

raciones

No hay lugar como el hogar, y no hay dos hogares iguales. La forma en que cuidamos nuestro propio hogar es tan única como nosotros, cada uno con diferentes gustos, preferencias y necesidades. Para ayudarte a inspirarte y crear el ambiente de la cocina de tus sueños, hemos desarrollado tres **familias** de productos diferentes.

Pasión por los detalles

Mythos

Nuestra gama más premium. La tecnología se une al diseño, y hasta los detalles más diminutos se cuidan al milímetro. Esta familia se pone como objetivo más alto, combinando la esencia misma de la funcionalidad con la de la belleza.

Para toda la familia

Maris

Una **familia** inspirada en las familias. Acogedora y funcional, para saborear la experiencia de una reunión **familiar**. La filosofía de Maris es clara: acoger a todo el mundo, en cualquier momento, con el orgullo y la alegría de una comida hecha en casa.

Directo a lo importante

Smart

Las cosas más sencillas son las que mejor funcionan. Esencial en su perfección, para saltar a lo que más importa: dar alegría a tu cocina. Una familia creada para satisfacer cualquier necesidad y preferencia.

Cómo será tu cocina depende de ti, pero sea cual sea tu forma de llevar la alegría al hogar, **puedes contar con nosotros.**



Cubetas

Fregaderos

Girifos

Campanas

Electrodomésticos

Gestión de residuos

Accesorios

Cubetas

Fregaderos

Grifos

Campanas

Electrodomésticos

Gestión de residuos

Accesorios



Mythos



Cubeta: Mythos Masterpiece - BXM 110-68 Antracita
Grifo: Eos Neo - Pull Down Antracita
Dispensador de Jabón: Atlas Antracita



Placa con Campana integrada: Mythos 2gether - FMY 839 HI



Horno: Mythos - FMY 99 P XS
Cafetera Integrada: Mythos - FMY 45 CM XS
Vinoteca: Mythos - FMY 24 WCR XS
Calienta Platos: Mythos - FMY 14 DRW XS

Cubetas

Fregaderos

Grifos

Campanas

Electrodomésticos

Gestión de residuos

Accesorios



Mythos



Cubeta: Kubus 2 - KNG 110-62

Grifo: Icon - Pull Out



Horno: Mythos - FMY 98 P XS

Microondas: Mythos - FMY 45 MW XS

Cafetera Integrable: Mythos - FMY 45 CM XS

Calienta platos: Mythos - FMY 14 DRW XS

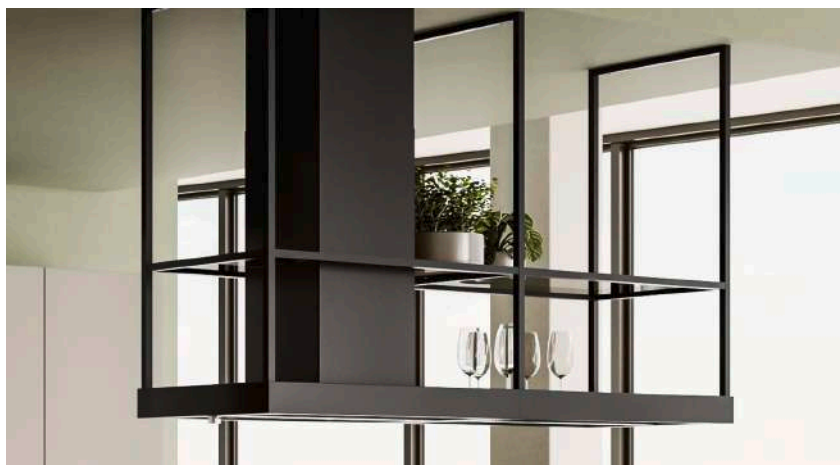

Campana: Mythos - T-Shelf

Cubetas

Fregaderos

Grifos

Campanas

Electrodomésticos

Gestión de residuos

Accesorios



Mythos



Cubeta: Mythos - MYX 210-70

Accesorio: Roll-Up

Grifo: Vital - Semi-Pro

Dispensador de Jabón: Atlas

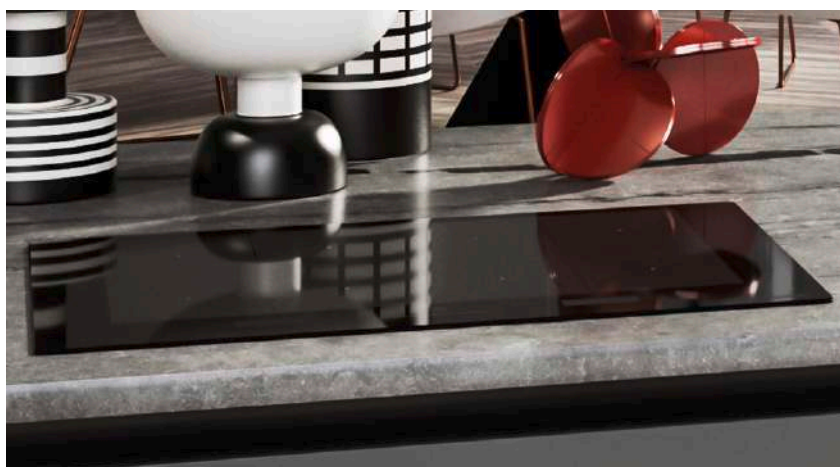

Placa: Mythos - Total Flex 658 BK

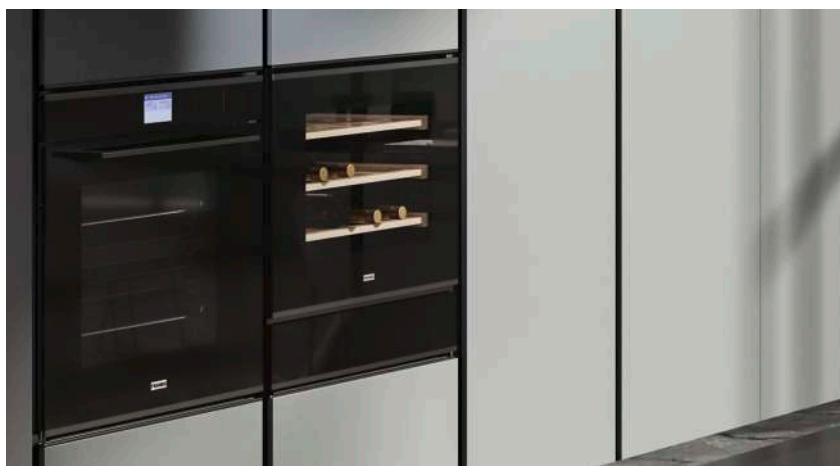

Horno: Mythos - FMY 99 HS BK

Vinoteca: Mythos - FMY 24 WCR BK

Calienta Platos: Mythos - FMY 14 DRW BK

Cubetas

Fregaderos

Grifos

Campanas

Electrodomésticos

Gestión de residuos

Accesorios



Maris



Cubeta: Maris Black Collection - MRG 610-72 TL

Grifo: Active - Pull Out Spray Negro

Dispensador de Jabón: Active Negro



Placa con Campana Integrada: Maris 2gether - FMA 839 HI



Horno: Maris - FMA 97 P XS

Microondas: Maris - FMA 45 MW XS

Cubetas

Fregaderos

Grifos

Campanas

Electrodomésticos

Gestión de residuos

Accesorios

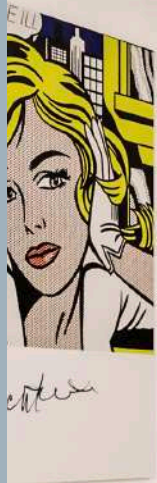

Maris

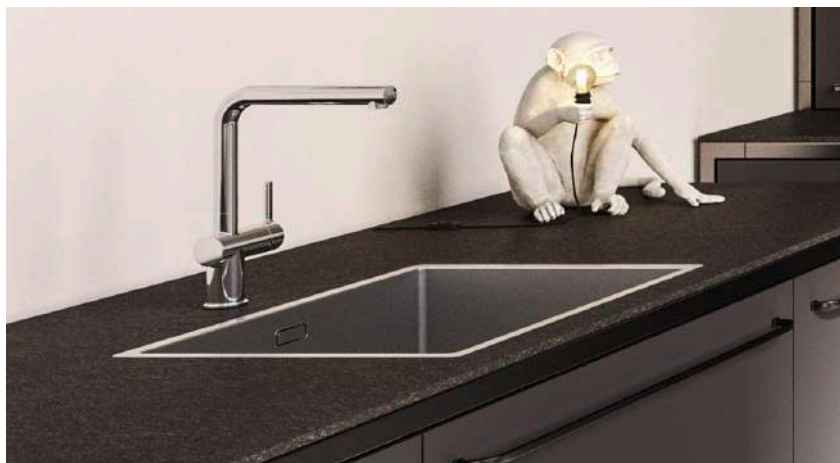

Cubeta: Maris - MRX 210-70

Grifo: Active - Swivel



Campana: Maris 2.0 - FMA 2.0 607 BK

Placa: Maris - FMA 654 I F BK



Horno: Maris - FMA 86 H XS

Microondas: Maris - FMA 45 MW XS

Cubetas

Fregaderos

Grifos

Campanas

Electrodomésticos

Gestión de residuos

Accesorios





Fregadero: Sirius 2.0 - S2D 611 - 110
Grifo: Lina - Swivel



Campana: Smart Deco - FSMD 508 YL
Horno: Smart - FSM 97 P XS
Microondas: Smart - FSM 45 MW XS

¡Demuestra de lo que estás hecho!

Brillante o mate; liso o como una piedra, extrafuerte o súper moderno. Tu cocina lo dice todo de ti, así que cada detalle cuenta. Para ofrecerte la posibilidad de crear tu cocina perfecta, nuestra gama de materiales está diseñada para complacer cualquier gusto, combinar con cualquier estilo y resistir cualquier desafío. Descubre el carácter de precisión de cada material y sus ventajas únicas para elegir el que mejor se adapte a tus necesidades y que más te guste.

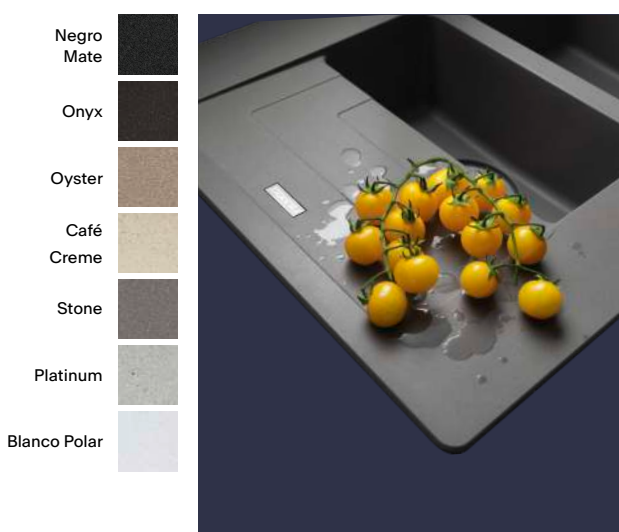

Fragranite

Un material extremadamente duro, muy resistente a altas temperaturas, arañazos, agentes abrasivos y manchas. Creado por Franke, es un material único con un brillo sutil y cálido al tacto gracias a su 80% de granito. Además, el Fragranite tratado con Sanitized® reduce el crecimiento de bacterias y microbios en un 99%. Una característica más que importante para nuestras cocinas, ya que las bacterias pueden multiplicarse cada 20 minutos haciendo que las superficies de la cocina sean altamente antihigiénicas.

Tectonite

El calor, los golpes y los impactos no intimidan a nuestros fregaderos y cubetas de Tectonite. La robustez combinada con una libertad de diseño única hace que los fregaderos Tectonite sea la elección definitiva para las cocinas más trabajadoras y elegantes. La nueva tecnología representa un gran avance para los materiales sintéticos, al tiempo que permite diseños minimalistas, también ofrece una gran paleta de colores y robustez.

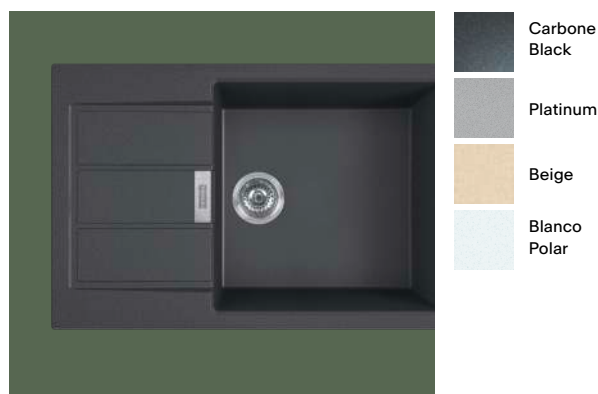

Tecnología F-Inox

Un revestimiento exclusivo de Franke capaz de agrupar las moléculas de agua y que permite secar el fregadero sin manchas de anillos. Repelente al agua y resistente a los arañazos, este revestimiento vanguardista tampoco teme el calor (hasta 350 C°). Una fórmula de belleza real y duradera que puedes apreciar en nuestra familia Masterpiece.



Acero Inoxidable

Tanto si prefieres los detalles más brillantes del acabado pulido o el aspecto más sutil de los acabados sedoso o cepillado, que dan un brillo más mate, hay una solución de acero inoxidable para ti. Todos los productos de acero inoxidable Franke están fabricados con acero al cromo-níquel de primera calidad, que tiene un aspecto impresionante y es muy resistente a las manchas, el óxido y la corrosión. No se astilla, agrieta, descascarilla ni rompe. Si el acero inoxidable es uno de los materiales más populares en la cocina, es por una buena razón.

Revestimiento PVD

El PVD, que significa "Physical Vapor Deposition", es una tecnología de revestimiento que hace que la grifería sea aún más resistente a la corrosión, a los arañazos y a la abrasión, además de ofrecer unas características estéticas excepcionales. Un grifo tratado con un revestimiento PDV resiste incluso los rayos UV y hace que las huellas dactilares sean menos visibles en las cocinas más concurridas. Disponibles en diferentes acabados, siendo el cromo el más solicitado. Cromo sigue siendo el más popular, pero ahora hay una gran variedad de otros acabados entre los que elegir. Desde el acero inoxidable puro, que combina belleza y durabilidad, el latón y el bronce de cañón, el negro industrial, el cobre y el oro. Podrás encontrar algo que se adapte a cada estilo de cocina.



Onyx
Blanco
Polar

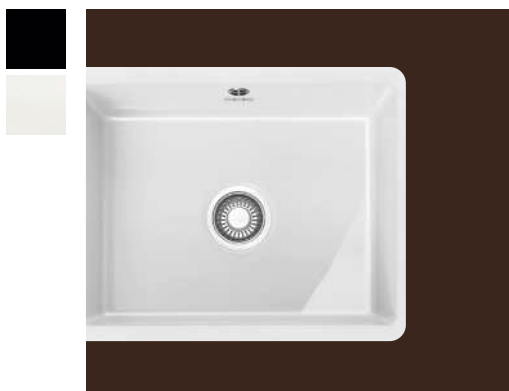

Fraceram

Los fregaderos de cerámica tienen una superficie lisa e impermeable, que soporta calor, las manchas, los impactos y resiste a todos los productos químicos del hogar con facilidad. Los fregaderos de cerámica han sido una opción popular desde hace años y crean una combinación clásica con una variedad de superficies de trabajo, como la madera, el vidrio y el granito.

Calidad por encima de todo

Visualmente atractivo y funcional en su uso, el acero FRANKE describe nuestro concepto de calidad y durabilidad.

La gran calidad de los productos Franke se puede ver y tocar. Utilizamos acero AISI 304 18/10, que se produce en Europa. Una elección que refleja calidad y que ha sido siempre una prioridad durante estos más de 100 años de historia.

Fuerte y robusto, el acero Franke describe nuestro concepto de calidad y durabilidad. Su brillo extraordinario es cautivador y sorprendente, característica que lo define en los espacios habitables donde se instala.

Sus excelentes características técnicas hacen que sea solicitado y muy apreciado por los profesionales del sector. Además, el acero inoxidable es un material extremadamente higiénico, fácil de limpiar y reciclable. Estéticamente agradable y funcional, el acero inoxidable es el corazón de nuestro concepto de cocina

Duradero

Las concentraciones específicas de níquel y cromo del acero AISI 304 18/10 lo hacen especialmente resistente a las temperaturas extremas. Su brillo no se desvanece en el tiempo, por el contrario, su belleza y atracción aumentan.

Fácil de mantener

El acero es un material fácil de mantener; basta con seguir unos sencillos pasos para garantizar su excelencia y durabilidad en el paso del tiempo.

Funcional

El acero es el material elegido por los profesionales de cocina, por ser resistente, higiénico y duradero. Su superficie no porosa es muy fácil de limpiar.

Sostenible y ecológico

Un material respetuoso con el medio ambiente y 100% reciclable, puede obtenerse a partir de materiales reutilizados y se produce sin residuos tóxicos.



Cubetas

Fregaderos

Girfos

Campanas

Electrodomésticos

Gestión de residuos

Accesorios

Cubetas

Fregaderos

Grifos

Campanas

Electrodomésticos

Gestión de residuos

Accesorios





Cubetas Inox

32	F-Inox / Masterpiece
36	Box Center
38	Mythos
42	Box BBX
46	Maris
52	Bmg
54	Smart
55	Rambla
55	Armonía

Cubetas

Fregaderos

Girfos

Campanas

Electrodomésticos

Gestión de residuos

Accesorios

Cubetas inox

Cubetas

Fregaderos

Grifos

Campanas

Electrodomésticos

Gestión de residuos

Accesorios

Mueble
de 45 cm

Mueble
de 50 cm

Mueble
de 55 cm

MYTHOS



NEW

BXM
210/110-40
p. 35



NEW

BXM
210/110-40
p. 35



NEW

BXM
210/110-50
p. 35



MYTHOS MYX
210-45
p. 40



MYTHOS MYX
110-45
p. 41

MARIS



BOX BXX
210-36
p. 44



BOX BXX
210-40
p. 44



MARIS MRX
210-40
p. 49



MARIS MRX
210-45
p. 49



MARIS MRX
110-45
p. 51



MARIS MRX
110-40
p. 51



BOX BXX
210-50
p. 44



BOX BXX
210-45
p. 44



BOX BXX
110-45
p. 45



MARIS MRX
210-40 TL
p. 49



MARIS MRX
210-50
p. 48



MARIS MRX
210-50 TL
p. 48

SMART



BMG P
p. 53



BMG PI
p. 53



NEW

BMG 210-40
TL
p. 52



NEW

SRX-210 FREG.
p. 54



NEW

BMG 210-50 TL
p. 52



BMG MU 2.0
p. 52

Productos Standalone



RAX-610-38
p. 54

Mueble de 60 cm



BXM
210/110-50
p. 35



MYTHOS MYX
210-50
p. 39



MYTHOS MYX
110-50
p. 41



BOX BXX
260-34-16
p. 43



BOX BXX
210-54
p. 43



BOX BXX
210-50
p. 44



BOX BXX
110-50
p. 45



MARIS MRX
210-55
p. 48



MARIS MRX
110-50
p. 50



BMG MU
110-50
p. 53



BMG MU PLUS
p. 52



BMG I
p. 53



BMG ME
p. 54



ARMONÍA 160
p. 55

Mueble de 80 cm



BXM
210/110-68
p. 35



BWX 120-41-27
p. 37



MYTHOS MYX
210-70
p. 39



MYTHOS MYX
110-70
p. 40



BOX BXX
220-34-34
p. 43



BOX BXX
210-68
p. 43



BOX BXX
210-54
p. 43



BOX BXX
110-68
p. 45



MARIS MRX
210-70
p. 47



MARIS MRX
210-70 TL
p. 47



MARIS MRX
110-70
p. 50



MARIS MRX
110-55
p. 50



ARMONÍA 120
p. 55

Mueble de 90 cm



BWX 220-54-27 TL D/I
p. 37



MARIS MRX
220-40-40
p. 47

Cubetas

Fregaderos

Grifos

Campanas

Electrodomésticos

Gestión de residuos

Accesorios

Mythos

Masterpiece

Tu nueva obra de arte.



Dale a tu cocina y a tu hogar un aspecto elegante y artístico con los colores metálicos de moda de nuestra nueva familia Mythos Masterpiece. Una gama de cubetas, grifos, dispensadores de jabón, desagües, rebosaderos y más accesorios que brindan una estética excepcional con una calidad sin límites que da a tu cocina un aspecto único.

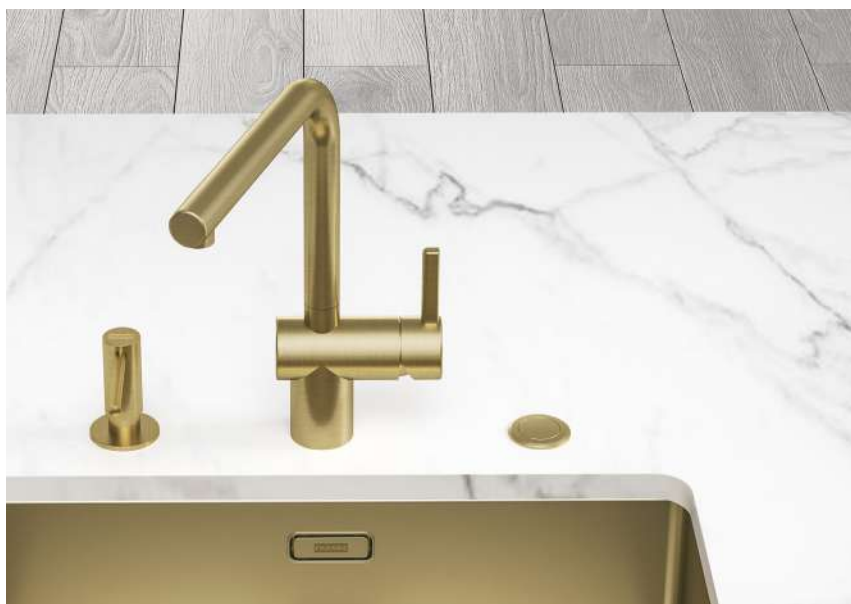

Eos Neo Extraíble



Atlas Neo
Dispensador de
jabón líquido

Combina la cubeta con los componentes en el mismo tono de color:



Pulsador



Válvula
Rebosadero



Válvula de
desagüe

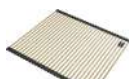

Roll-Up



Cubetilla

Sólo con las cubetas Mythos Masterpiece



Fácil de
limpiar



Mayor
resistencia
a arañazos



Resistente
al calor

Descubre F-Inox, un revestimiento exclusivo de Franke que concentra las moléculas de agua, permitiéndote secar tu fregadero sin marcas de anillos. Este revestimiento pionero repele el agua, aumenta la resistencia al rayado y resiste el agua caliente hirviendo. Una auténtica y duradera fórmula con la que hemos equipado todas las cubetas Mythos Masterpiece.

F-Inox / Mythos

Masterpiece



Accesorios



01

Rejilla soporte antracita 40 (incl.)
Accesorio Masterpiece
112.0655.431
49 €



02

Rejilla soporte antracita 50 (incl.)
Accesorio Masterpiece
112.0655.470
59 €



03

Rejilla soporte antracita 68 (incl.)
Accesorio Masterpiece
112.0655.408
79 €



04

Rejilla soporte cobre 40 (incl.)
Accesorio Masterpiece
112.0655.468
49 €



05

Rejilla soporte cobre 50 (incl.)
Accesorio Masterpiece
112.0655.472
59 €



06

Rejilla soporte cobre 68 (incl.)
Accesorio Masterpiece
112.0655.410
79 €



07

Rejilla soporte oro 40 (incl.)
Accesorio Masterpiece
112.0655.433
49 €



08

Rejilla soporte oro 50 (incl.)
Accesorio Masterpiece
112.0655.471
59 €



09

Rejilla soporte oro 68 (incl.)
Accesorio Masterpiece
112.0655.409
79 €



10

Rejilla HPL Premium
Accesorio Masterpiece
112.0676.895
499 €



19

Cubetilla inox antracita
429x156x53,5 mm
Accesorio Masterpiece
112.0655.239
119 €



20

Cubetilla inox oro
429x156x53,5 mm
Accesorio Masterpiece
112.0655.240
119 €



21

Cubetilla inox cobre
429x156x53,5 mm
Accesorio Masterpiece
112.0655.341
119 €

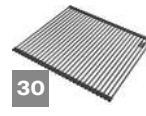

30

Escurreidor Roll-up antracita
Accesorio Masterpiece
112.0655.342
149 €



31

Escurreidor Roll-up oro
440x468 mm
Accesorio Masterpiece
112.0655.343
149 €



32

Escurreidor Roll-up cobre
440x468 mm
Accesorio Masterpiece
112.0655.344
149 €

34 Colección 2023

MYTHOS



5 AÑOS GARANTÍA



Mueble: 50 (Bajo encimera) 45 (A ras)
Instalación: Encastre / A ras / Bajo encimera
Material: Acero inoxidable
Recubrimiento: Tecnología F-Inox
Totales: 440 x 450 mm / R13
Cubeta: 400 x 410 x 200 mm / R12
Encastre: 410 x 420 mm

- Antracita**
127.0650.362
7612986112849
1.399 €
- Oro**
127.0662.648
7612986117899
1.399 €
- Cobre**
127.0662.649
7612986117905
1.399 €

NEW

MYTHOS MASTERPIECE
BXM 210/110-40 + Válvula
automática + Rejilla de soporte



19 20 21 30 31 32

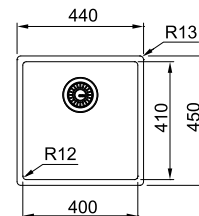

MYTHOS



5 AÑOS GARANTÍA



Mueble: 60 (Bajo encimera) 55 (A ras)
Instalación: Encastre / A ras / Bajo encimera
Material: Acero inoxidable
Recubrimiento: Tecnología F-Inox
Totales: 540 x 450 mm / R13
Cubeta: 500 x 410 x 200 mm / R12
Encastre: 510 x 420 mm

- Antracita**
127.0650.363
7612986112856
1.499 €
- Oro**
127.0662.540
7612986117837
1.499 €
- Cobre**
127.0662.642
7612986117844
1.499 €

NEW

MYTHOS MASTERPIECE
BXM 210/110-50 + Válvula
automática + Rejilla de soporte



19 20 21 30 31 32

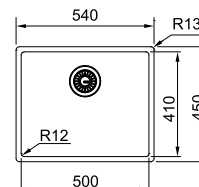

MYTHOS



5 AÑOS GARANTÍA



Mueble: 80
Instalación: Encastre / A ras / Bajo encimera
Material: Acero inoxidable
Recubrimiento: Tecnología F-Inox
Totales: 725 x 450 mm / R13
Cubeta: 685 x 410 x 200 mm / R12
Encastre: 695 x 420 mm

- Antracita**
127.0650.364
7612986112863
1.799 €
- Oro**
127.0662.643
7612986117851
1.799 €
- Cobre**
127.0662.644
7612986117868
1.799 €

NEW

MYTHOS MASTERPIECE
BXM 210/110-68 + Válvula
automática + Rejilla de soporte



10 19 20 21 30 31 32

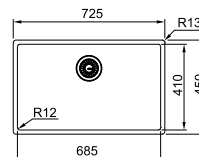

Box Center



Accesorios incluidos



26

**CUBETILLA INOX
BOX**
Cubetilla
112.0394.981
7612981698713
68 €



186

**Soporte cuchillos
429x180x23
Box center**
Accesorios Box
Center
112.0539.135
7612985515269
81 €



42

**Tabla madera
429x180x24
Box center**
Accesorios Box
Center
112.0539.134
7612985515252
99 €



188

**Set 3 cuchillos box
center**
Accesorios Box
Center
112.0545.792
7612985538138
26 €



189

**Escurridor
452x245x165
Box center**
Accesorios Box
Center
112.0539.138
7612985515290
41 €

MYTHOS



DE POR VIDA GARANTÍA



DESIGN AWARD 2019



Mueble: 90
Instalación: Encastre / A ras
Totales: 860 x 510; R10 mm
Cubetas: 540 x 410 x 204; R12 mm/270 x 480 x 204 mm
Encastre: 840 x 490 mm R10

BOX CENTER
BWX 220-54-27 TL
Accesorios derecha
127.0538.259
7612985512275
1.674 €

BOX CENTER
BWX 220-54-27 TL
Accesorios izquierda
127.0538.260
7612985512282
1.674 €

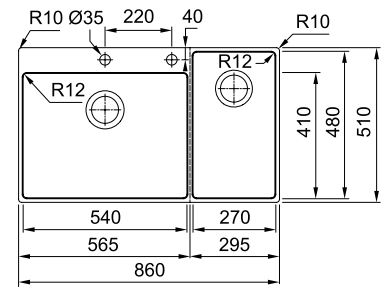

Acero Inoxidable



26 186 42 188 189

MYTHOS



DE POR VIDA GARANTÍA



DESIGN AWARD 2019



Mueble: 90
Instalación: Bajo encimera
Totales: 820 x 520; R10 mm
Cubetas: 410 x 480 x 204; R12 mm / 270 x 480 x 204 mm
Bajo encimera: 780 x 480; R12 mm

BOX CENTER
BWX 120-41-27
122.0579.553
7612985688925
1.581 €

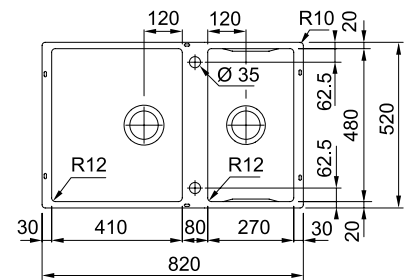

Acero Inoxidable



26 186 42 188 189 190

Cubetas

Fregaderos

Grifos

Campanas

Electrodomesticos

Gestión de residuos

Accesorios

Mythos



Accesorios opcionales

24



Cubetilla
158,4x416x53,5 mm
Cubetilla
112.0659.398
7612986099300
99 €

27



Cubetilla inox mtx
172x412x55 mm
Cubetilla
112.0057.850
7612980040674
48 €

33



Escurredor móvil
298x412x17 mm
Escurredor móvil
112.0602.288
7612985772938
122 €

37



Roll-up
424 x 267 mm
Escurredor
enrollable
112.0591.081
7612985731454
76 €

44



Tabla de corte
412x180x13mm
Tabla de corte
112.0591.082
7612985731461
99 €

50



Sifón salvaespacio
1 Via salida 40mm
Sifón
112.0048.206
7612319502767
19 €

38 Colección 2023

MYTHOS

- 24
- 27
- 33
- 37
- 44
- 50



Mueble: **80 cm**
 Instalación: **Encastre / A ras**
 Material: **Acero inoxidable**
 Totales: **712 x 412; R31 mm**
 Cubeta: **700 x 400 x 200; R25 mm**
 Encastre: **706 x 406; R28 mm**



MYTHOS MYX 210-70
 127.0603.546
 7612985776875
769 €

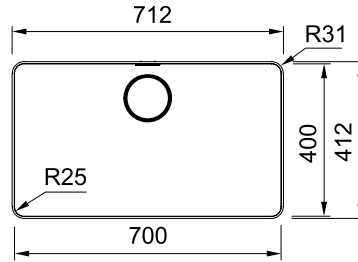

MYTHOS

- 24
- 27
- 33
- 37
- 44
- 50



Mueble: **60 cm**
 Instalación: **Encastre / A ras**
 Material: **Acero inoxidable**
 Totales: **512 x 412; R31 mm**
 Cubeta: **500 x 400 x 200; R25 mm**
 Encastre: **506 x 406; R28 mm**

MYTHOS MYX 210-50
 127.0603.544
 7612985776851
653 €

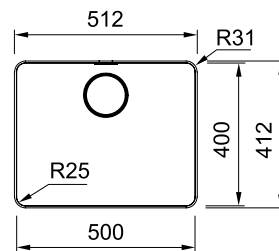

MYTHOS



- 24
- 27
- 33
- 37
- 44
- 50



Mueble: **55 cm**
 Instalación: **Encastre / A ras**
 Material: **Acero inoxidable**
 Totales: **462 x 412; R31 mm**
 Cubeta: **450 x 400 x 200 mm R25**
 Encastre: **456 x 406; R28 mm**

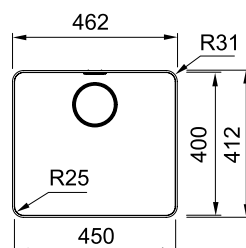

MYTHOS MYX 210-45
127.0603.543
 7612985776844
630 €



MYTHOS



- 24
- 27
- 33
- 37
- 44
- 50



Mueble: **80 cm**
 Instalación: **Bajo encimera**
 Material: **Acero inoxidable**
 Totales: **740 x 440; R10 mm**
 Cubeta: **700 x 400 x 200; R25 mm**
 Bajo encimera: **700 x 400 mm R25**

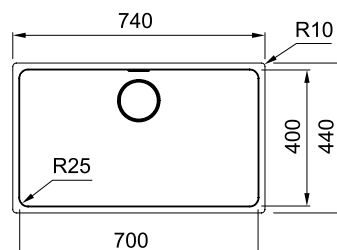

MYTHOS MYX 110-70
122.0601.280
 7612985769761
653 €



MYTHOS

- 24
- 27
- 33
- 37
- 44
- 50



Mueble: **60 cm**
 Instalación: **Bajo encimera**
 Material: **Acero inoxidable**
 Totales: **540 x 440; R10 mm**
 Cubeta: **500 x 400 x 200; R25 mm**
 Bajo encimera: **500 x 400 mm R25**

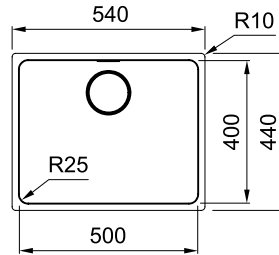

MYTHOS MYX 110-50
 122.0601.316
 7612985770668
 572 €



MYTHOS

- 24
- 27
- 33
- 37
- 44
- 50



Mueble: **55 cm**
 Instalación: **Bajo encimera**
 Material: **Acero inoxidable**
 Totales: **490 x 440; R10 mm**
 Cubeta: **450 x 400 x 200; R25 mm**
 Bajo encimera: **450 x 400 mm R25**

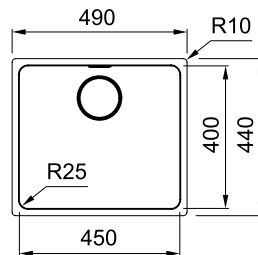

MYTHOS MYX 110-45
 122.0601.315
 7612985770651
 549 €



Cubetas

Fregaderos

Grifos

Campanas

Electrodomésticos

Gestión de residuos

Accesorios

Box BXX



Accesorios opcionales

26



Cubetilla inox
429x156,4x53,5 mm
 Cubetilla
 112.0394.981
 7612981698713
68 €

16



Andy chef
 Accesorio Andy
 Chef
 112.0619.946
 7612985856683
403 €

50



Sifon salvaespacio
1 Via salida 40mm
 Sifón
 112.0048.206
 7612319502767
19 €

42 Colección 2023

MARIS



Mueble: **80 cm**
 Instalación: **Encastre / A ras /Bajo encimera**
 Material: **Acero inoxidable**
 Totales: **740 x 450; R13 mm**
 Cubetas: **340 x 410 x 200; R12 mm**
 Encastre: **710 x 420; R10 mm**

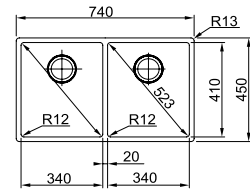

Acero Inoxidable

BOX BXX 220-34-34
127.0373.651
 7612981601621
784 €



MARIS



Mueble: **60 cm**
 Instalación: **Encastre / A ras /Bajo encimera**
 Material: **Acero inoxidable**
 Totales: **560 x 450; R13 mm**
 Cubetas: **340 x 410 x 200; R12 mm**
160 x 410 x 140 mm
 Encastre: **530 x 420; R10 mm**

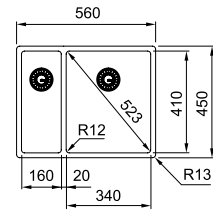

Acero Inoxidable

BOX BXX 260-34-16
127.0373.630
 7612981601614
746 €



MARIS



Mueble: **80 cm**
 Instalación: **Encastre / A ras /Bajo encimera**
 Material: **Acero inoxidable**
 Totales: **725 x 450; R13 mm**
 Cubeta: **685 x 410 x 200; R12 mm**
 Encastre: **695 x 420; R0-15 mm**
 Bajo encimera: **685 x 410; R12 mm**

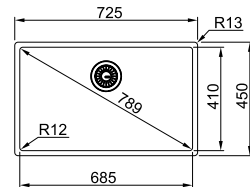

Acero Inoxidable

BOX BXX 210-68
127.0381.329
 7612981626709
519 €



MARIS



Mueble: **60 cm A ras/Encastre**
80 cm Bajo encimera
 Instalación: **Encastre / A ras /Bajo encimera**
 Material: **Acero inoxidable**
 Totales: **580 x 450; R13 mm**
 Cubeta: **540 x 410 x 200; R12 mm**
 Encastre: **550 x 420 mm R10 mm**
 Bajo encimera: **540 x 410; R12 mm**

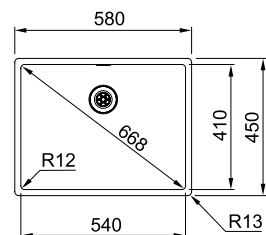

Acero Inoxidable

BOX BXX 210-54
127.0372.644
 7612981596750
438 €



Cubetas

Fregaderos

Grifos

Campanas

Electrodomésticos

Gestión de residuos

Accesorios

MARIS

26

16

50



DE POR VIDA

GARANTÍA

Acero Inoxidable

BOX BXX 210-50
127.0381.510
 7612981627157
403 €

Mueble: **55 cm A ras/Encastre**
60 cm Bajo encimera
 Instalación: **Encastre / A ras /Bajo encimera**
 Material: **Acero inoxidable**
 Totales: **540 x 450; R13 mm**
 Cubeta: **500 x 410 x 200; R12 mm**
 Encastre: **510 x 420; R10 mm**
 Bajo encimera: **500 x 410; R12 mm**

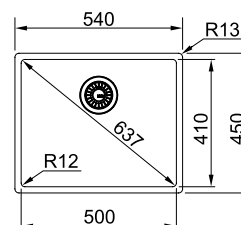

MARIS

26

16

50



DE POR VIDA

GARANTÍA

Acero Inoxidable

BOX BXX 210-45
127.0373.629
 7612981601508
392 €

Mueble: **50 cm A ras/Encastre**
55 cm Bajo encimera
 Instalación: **Encastre / A ras /Bajo encimera**
 Material: **Acero inoxidable**
 Totales: **490 x 450; R13 mm**
 Cubeta: **450 x 410 x 200; R12 mm**
 Encastre: **460 x 420; R10 mm**
 Bajo encimera: **450 x 410; R12 mm**

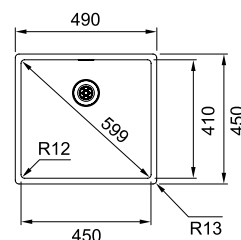

MARIS

26

16

50



DE POR VIDA

GARANTÍA

Acero Inoxidable

BOX BXX 210-40
127.0381.328
 7612981626693
380 €

Mueble: **45 cm**
 Instalación: **Encastre / A ras /Bajo encimera**
 Material: **Acero inoxidable**
 Totales: **440 x 450; R13 mm**
 Cubeta: **400 x 410 x 200; R12 mm**
 Encastre: **410 x 420; R10 mm**
 Bajo encimera: **400 x 410; R12 mm**

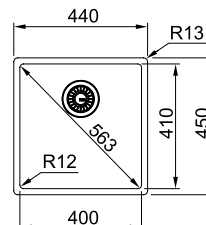

MARIS

26

16

50



DE POR VIDA

GARANTÍA

Acero Inoxidable

BOX BXX 210-36
127.0381.327
 7612981626686
369 €

Mueble: **45 cm**
 Instalación: **Encastre / A ras /Bajo encimera**
 Material: **Acero inoxidable**
 Totales: **400 x 450; R13 mm**
 Cubeta: **360 x 410 x 200; R12 mm**
 Encastre: **370 x 420; R10 mm**
 Bajo encimera: **360 x 410; R12 mm**

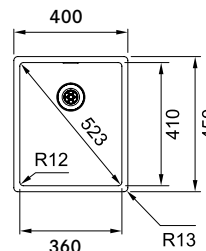

MARIS

26
16
50



Mueble: **80 cm**
Instalación: **Bajo encimera**
Material: **Acero inoxidable**
Totales: **725 x 450; R13 mm**
Cubeta: **685 x 410 x 200; R12 mm**
Bajo encimera: **685 x 410; R12 mm**

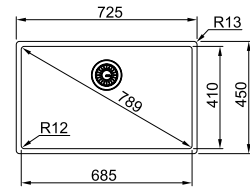

DE POR VIDA
GARANTÍA



Acero
Inoxidable

BOX BXX 110-68
122.0393.818
7612981694678
461 €



MARIS

26
16
50



Mueble: **60 cm**
Instalación: **Bajo encimera**
Material: **Acero inoxidable**
Totales: **540 x 450; R13 mm**
Cubeta: **500 x 410 x 200; R12 mm**
Bajo encimera: **500 x 410; R12 mm**

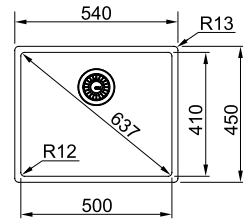

DE POR VIDA
GARANTÍA



Acero
Inoxidable

BOX BXX 110-50
122.0393.811
7612981694678
345 €



MARIS

26
16
50



Mueble: **55 cm**
Instalación: **Bajo encimera**
Material: **Acero inoxidable**
Totales: **490 x 450; R13 mm**
Cubeta: **450 x 410 x 200; R12 mm**
Bajo encimera: **450 x 410; R12 mm**

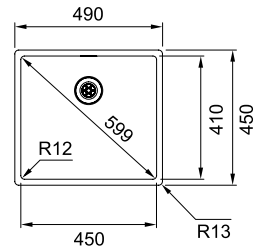

DE POR VIDA
GARANTÍA



Acero
Inoxidable

BOX BXX 110-45
122.0393.807
7612981694623
334 €



MARIS

26
16
50



Mueble: **50 cm**
Instalación: **Bajo encimera**
Material: **Acero inoxidable**
Totales: **440 x 450; R13 mm**
Cubeta: **400 x 410; R12 mm**
Bajo encimera: **400 x 410; R12 mm**

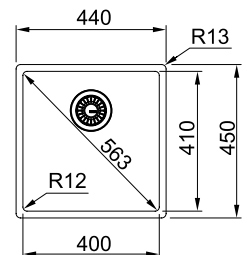

DE POR VIDA
GARANTÍA



Acero
Inoxidable

BOX BXX 110-40
122.0393.781
7612981694555
322 €



Cubetas

Fregaderos

Grifos

Campanas

Electrodomesticos

Gestión de residuos

Accesorios

Maris



Accesorios opcionales



38
Roll-up 468 x 420 mm
 Escurreidor enrollable
 112.0030.882
 7612142241574
80 €



27
Cubetilla perforada inox
MTX 412x172x55 mm
 Cubetilla
 112.0057.850
 7612980040674
48 €



34
Escurreidor móvil
342x430x22
 Escurreidor móvil
 112.0188.651
 7612980584215
108 €



50
Sifon salvaespacio
1 vía salida 40mm
 Sifón
 112.0048.206
 7612319502767
19 €



51
Sifon salvaespacio
2 vías salida 40mm
 Sifón
 112.0624.484
 7612985884273
27 €



11
All-In
Guía-cubetilla-placa
corte
 Accesorios All -In
 112.0655.481
 7612986084603
138 €



12
All-In
Guía-bolx2-placa de
corte
 Accesorios All -In
 112.0655.482
 7612986084610
161 €

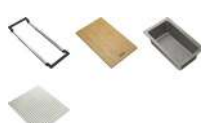

13
All-In
Guía-cubetilla-
Placa corte-escurreidor
 Accesorios All -In
 112.0655.483
 7612986084627
195 €



23
CUBETILLA MRX TL
181x431mm
 Cubetilla
 112.0520.497
 7612985441230
103 €

MARIS

38

27

34

51

11

12

13



Mueble: 90 cm
 Instalación: A ras / Encastre
 Material: Acero inoxidable
 Totales: 861 x 436; R10 mm
 Cubetas: 400 x 400 x 180; R16 mm
 Encastre: 835 x 410; R10 mm

Acero
Inoxidable

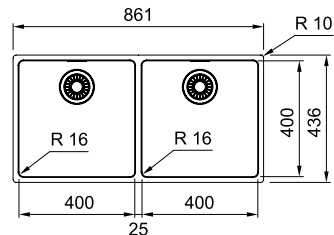

MARIS MRX 220-40-40
 127.0531.914
 7612985485708
 773 €



DEPOR
VIDA
GARANTÍA

Cubetas

Fregaderos

MARIS

11

12

13

34

38

50

23



Mueble: 80 cm
 Instalación: A ras / Encastre
 Material: Acero inoxidable
 Totales: 730 x 510; R10 mm
 Cubeta: 700 x 400 x 180; R16 mm
 Encastre: 710 x 490; R10 mm
 Con orificio de grifo centrado

Acero
Inoxidable

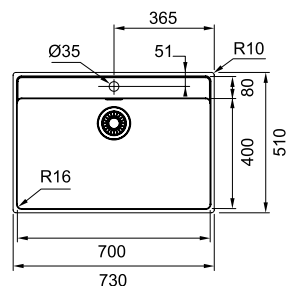

MARIS MRX 210-70 TL
 127.0529.812
 7612985476577
 484 €



DEPOR
VIDA
GARANTÍA

Grifos

Campanas

MARIS

38

27

34

50

11

12

13



Mueble: 80 cm
 Instalación: A ras / Encastre
 Material: Acero inoxidable
 Totales: 740 x 440; R10 mm
 Cubeta: 700 x 400 x 180; R16 mm
 Encastre: 710 x 410; R10 mm

Acero
Inoxidable

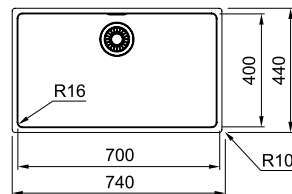

MARIS MRX 210-70
 127.0529.811
 7612985476560
 473 €



DEPOR
VIDA
GARANTÍA

Electrodomésticos

Gestión de residuos

Accesorios

MARIS

38

27

34

50

11

12

13



Mueble: 60 cm
 Instalación: A ras / Encastre
 Material: Acero inoxidable
 Totales: 590 x 440; R10 mm
 Cubeta: 550 x 400 x 180; R16 mm
 Encastre: 560 x 410; R10 mm

Acero
 Inoxidable

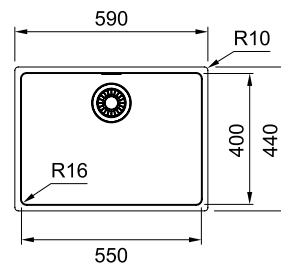

MARIS

34

38

50

23

11

12

13



Mueble: 55 cm
 Instalación: A ras / Encastre
 Material: Acero inoxidable
 Totales: 530 x 510; R10 mm
 Cubeta: 500 x 400 x 180; R16 mm
 Encastre: 510 x 490; R10 mm
 Con orificio de grifo centrado

Acero
 Inoxidable

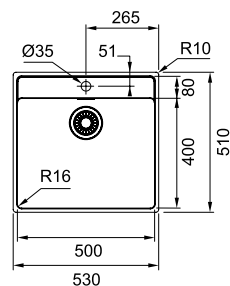

MARIS MRX 210-50 TL
 127.0529.810
 7612985476553
 357 €

DE POR
 VIDA
 GARANTÍA

MARIS

38

27

34

50

11

12

13



Mueble: 55 cm
 Instalación: A ras / Encastre
 Material: Acero inoxidable
 Totales: 540 x 440; R10 mm
 Cubeta: 500 x 400 x 180; R16 mm
 Encastre: 510 x 410; R10 mm

Acero
 Inoxidable

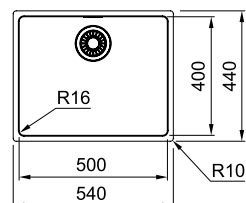

MARIS MRX 210-50
 127.0529.809
 7612985476546
 322 €

DE POR
 VIDA
 GARANTÍA

MARIS

27

34

50

11

12

13



Mueble: 45 cm
 Instalación: A ras / Encastre
 Material: Acero inoxidable
 Totales: 430 x 510; R10 mm
 Cubeta: 400 x 400 x 180; R16 mm
 Encastre: 410 x 490; R10 mm
 Con orificio de grifo centrado

Acero
Inoxidable

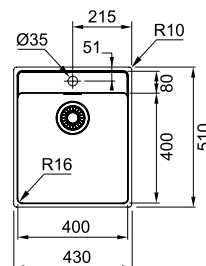

DE POR VIDA

GARANTÍA

MARIS MRX 210-40 TL
 127.0529.807
 7612985476539
 334 €

Cubetas

Fregaderos

MARIS

38

27

34

50

11

12

13



Mueble: 50 cm
 Instalación: A ras / Encastre
 Material: Acero inoxidable
 Totales: 490 x 440; R10 mm
 Cubeta: 450 x 400 x 180; R16 mm
 Encastre: 460 x 410 mm R10

Acero
Inoxidable

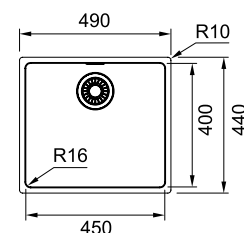

DE POR VIDA

GARANTÍA

MARIS MRX 210-45
 127.0564.243
 7612985632218
 299 €

Grifos

Campanas

Electrodomésticos

MARIS

38

27

34

50

11

12

13



Mueble: 45 cm
 Instalación: A ras / Encastre
 Material: Acero inoxidable
 Totales: 440 x 440; R10 mm
 Cubeta: 400 x 400 x 180; R16 mm
 Encastre: 410 x 410; R10 mm

Acero
Inoxidable

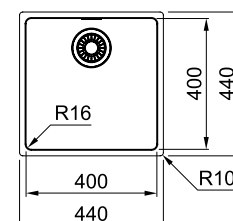

DE POR VIDA

GARANTÍA

MARIS MRX 210-40
 127.0529.805
 7612985476522
 276 €

Gestión de residuos

Accesorios

MARIS

38

27

34

50

11

12

13



Mueble: **80 cm**
 Instalación: **Bajo encimera**
 Material: **Acero inoxidable**
 Totales: **740 x 440; R10 mm**
 Cubeta: **700 x 400 x 180; R16 mm**
 Bajo encimera: **700 x 400; R16 mm**

Acero
Inoxidable

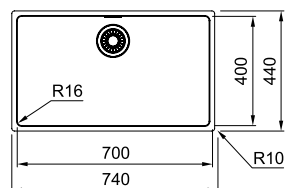

DE POR
VIDA
GARANTÍA

MARIS MRX 110-70
 122.0529.427
 7612985475419
 392 €

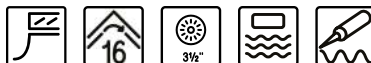

MARIS

34

38

50

27

11

12

13



Mueble: **80 cm**
 Instalación: **Bajo encimera**
 Material: **Acero inoxidable**
 Totales: **590 x 440; R10 mm**
 Cubeta: **550 x 400 x 180; R16 mm**
 Bajo encimera: **550 x 400 mm; R16**

Acero
Inoxidable

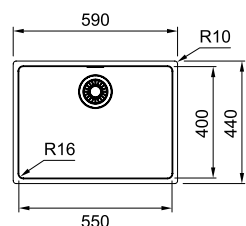

DE POR
VIDA
GARANTÍA

MARIS MRX 110-55
 122.0564.244
 7612985632225
 299 €



MARIS

38

27

34

50

11

12

13



Mueble: **60 cm**
 Instalación: **Bajo encimera**
 Material: **Acero inoxidable**
 Totales: **540 x 440; R10 mm**
 Cubeta: **500 x 400 x 180; R16 mm**
 Bajo encimera: **500 x 400 mm; R16**

Acero
Inoxidable

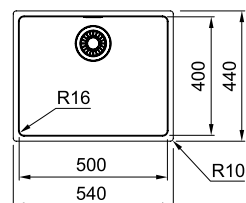

DE POR
VIDA
GARANTÍA

MRX 110-50
 122.0529.423
 7612985475402
 276 €

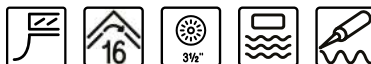

MARIS

38

27

34

50

11

12

13



Mueble: **50 cm**
Instalación: **Bajo encimera**
Material: **Acero inoxidable**
Totales: **490 x 440; R10 mm**
Cubeta: **450 x 400 x 180; R16 mm**
Bajo encimera: **450 x 400 mm R16**

Acero
Inoxidable

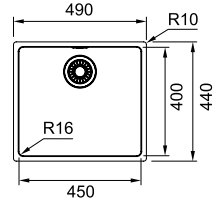

MARIS MRX 110-45
122.0564.242
7612985632201
253 €

DE POR
VIDA
GARANTÍA

Cubetas

Fregaderos

Grifos

MARIS

38

27

34

50

11

12

13



Mueble: **50 cm**
Instalación: **Bajo encimera**
Material: **Acero inoxidable**
Totales: **440 x 440; R10 mm**
Cubeta: **400 x 400 x 180; R16 mm**
Bajo encimera: **400 x 400 mm R16**

Acero
Inoxidable

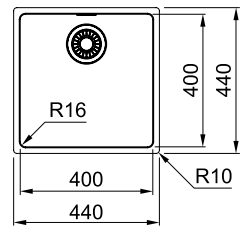

MARIS MRX 110-40
122.0529.310
7612985474979
237 €

DE POR
VIDA
GARANTÍA

Campanas

Electrodomésticos

Gestión de residuos

Accesorios

SMART

DE POR VIDA
GARANTÍA



Mueble: **55 cm**
 Instalación: **A ras / Encastre**
 Material: **Acero inoxidable**
 Totales: **530 x 510 mm**
 Cubeta: **500 x 400 x 170 mm; R15**
 Bajo encimera: **ver plantilla***

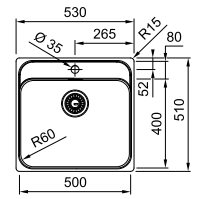

NEW

Acero
Inoxidable

BMG 210-50 TL
127.0692.945
 7612986292237
299 €



SMART

DE POR VIDA
GARANTÍA



Mueble: **45 cm**
 Instalación: **A ras / Encastre**
 Material: **Acero inoxidable**
 Totales: **510 x 430 mm**
 Cubeta: **400 x 400 x 170 mm; R15**

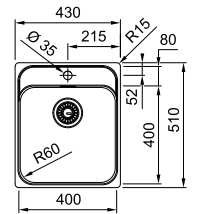

NEW

Acero
Inoxidable

BMG 210-40 TL
127.0692.828
 7612986292213
279 €



SMART

DE POR VIDA
GARANTÍA



Mueble: **55 cm**
 Instalación: **A ras / Encastre**
 Material: **Acero inoxidable**
 Totales: **541 x 441 mm**
 Cubeta: **500 x 400 x 171 mm**

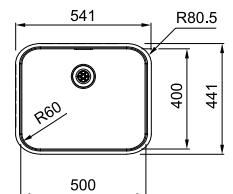

NEW

Acero
Inoxidable

BMG MU 2.0
127.0688.777
 7612986269703
191 €



11 12 13 14 15

SMART

DE POR VIDA
GARANTÍA



Mueble: **60 cm**
 Instalación: **Bajo encimera**
 Material: **Acero inoxidable**
 Totales: **510 x 430 mm**
 Cubeta: **480 x 400 x 190; R36 mm**

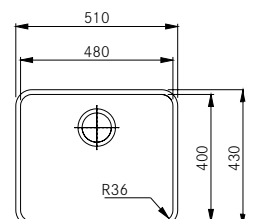

Acero
Inoxidable

BMG MU PLUS
122.0375.818
 7612981609764
173 €

BMG MU PLUS - 5/UNI.
122.0375.820
 7612981609771
171 €



50 11 12

SMART

DE POR VIDA
GARANTÍA



Mueble: **60 cm**
Instalación: **Bajo encimera**
Material: **Acero inoxidable**
Totales: **541 x 441 mm; R60**
Cubeta: **500 x 400 x 180 mm**

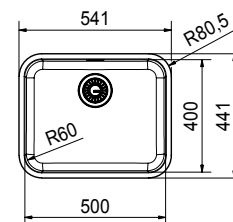

NEW

Acero Inoxidable

BMG MU 110-50*
122.0694.717
7612986302646
160 €
BMG MU 110-50 - 5/UNI. *
122.0696.406
7612986311211
154 €



* Disponible a partir de junio 2023

SMART

DE POR VIDA
GARANTÍA



Mueble: **45 cm**
Instalación: **Bajo encimera**
Material: **Acero inoxidable**
Totales: **370 x 430 mm**
Cubeta: **340 x 400 x 180; R70 mm**

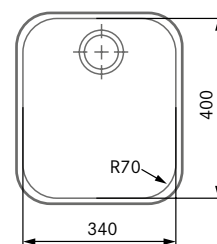

Acero Inoxidable

BMG P
122.0155.415
7612318077495
155 €

BMG P - 5/UNI.
122.0155.420
7612318077532
152 €

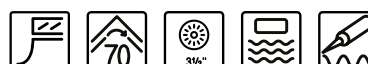

50 11 12

SMART

DE POR VIDA
GARANTÍA



Mueble: **45 cm**
Instalación: **Bajo encimera**
Material: **Acero inoxidable**
Totales: **332 x 372 mm**
Cubeta: **300 x 340 x 170 mm R50**

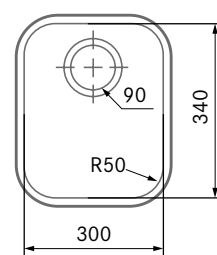

Acero Inoxidable

BMG PI
122.0155.416
7612318077501
154 €

BMG PI - 5/UNI.
122.0155.421
7612318077549
148 €

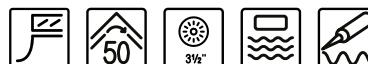

50 11 12

SMART

DE POR VIDA
GARANTÍA



Mueble: **60 cm**
Instalación: **Bajo encimera**
Material: **Acero inoxidable**
Totales: **480 x 430 mm**
Cubeta: **450 x 400 x 190; R70 mm**

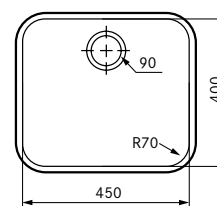

Acero Inoxidable

BMG I
122.0155.407
7612318077488
145 €

BMG I - 5/UNI.
122.0155.419
7612318077525
142 €



50 11 12

SMART



Mueble: **60 cm**
 Instalación: **Bajo encimera**
 Material: **Acero inoxidable**
 Totales: **428 x 428 mm**
 Cubeta: **400 x 400 x 190; R70 mm**

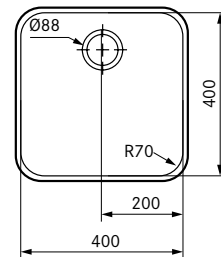

DE POR VIDA
GARANTÍA

Acero
Inoxidable

BMG ME
 122.0155.425
 7612318169145
143 €

BMG ME - 5/UNI.
 122.0155.426
 7612318169152
139 €



50 11 12

Smart

SMART



Mueble: **45 cm**
 Instalación: **A ras / Encastre**
 Material: **Acero inoxidable**
 Totales: **441 x 441; R80 mm**
 Cubeta: **400 x 400 X 171; R60 mm**

Acero
Inoxidable

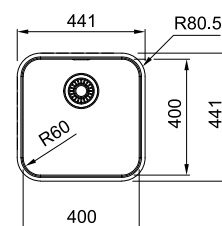

14

15

11

12

13

SMART
SRX-210
 127.0688.727
 7612986269604
168 €



DE POR VIDA
GARANTÍA

NEW

Rambla

Acero
Inoxidable



Mueble: **45 cm**
 Instalación: **Encastre**
 Material: **Acero inoxidable**
 Totales: **Ø 430x180 mm**
 Cubeta: **Ø 380x180 mm**
 Encastre: **Ø 414**

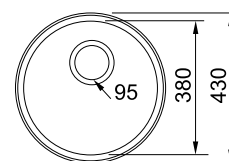

50

DE POR VIDA
GARANTÍA

RAMBLA
RAX-610-38
 101.0155.336
 7612318190873
156 €

RAMBLA
RAX-610-38 5/UNI.
 101.0155.337
 7612318190927
145 €



Armonía

SMART

11

12

DE POR
VIDA
GARANTÍA



Mueble: **80 cm**
Instalación: **Bajo encimera**
Material: **Acero inoxidable**
Totales: **765 x 450 mm**
Cubetas: **340 x 400 x 190 mm**
Bajo encimera: **ver plantilla***

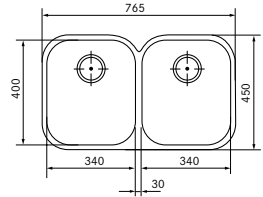

* Las plantillas de corte están disponibles en la página web www.franke.es



Acero
Inoxidable

ARMONÍA 120
122.0021.446
7612319198335
468 €

SMART

11

12

DE POR
VIDA
GARANTÍA



Mueble: **60 cm**
Instalación: **Bajo encimera**
Material: **Acero inoxidable**
Totales: **580 x 450 mm**
Cubetas: **340 x 400 x 190 mm / 165 x 306 x 130 mm**
Bajo encimera: **ver plantilla***

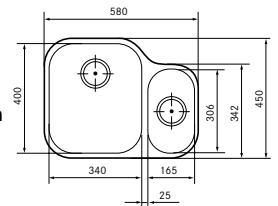

* Las plantillas de corte están disponibles en la página web www.franke.es



Acero
Inoxidable

ARMONÍA 160
122.0021.448
7612319198359
553 €

Cubetas

Fregaderos

Grifos

Campanas

Electrodomésticos

Gestión de residuos

Accesorios

Cubetas color

Cubetas

Fregaderos

Grifos

Campanas

Electrodomésticos

Gestión de residuos

Accesorios

Mueble de 20 cm

Mueble de 40 cm

Mueble de 45 cm

Mueble de 50 cm

Mueble de 55 cm

MYTHOS

MARIS

SMART



KNG 110-37
Fragranite
p. 67



KBK 110-40
Fraceram
p. 61



MRG 610-37 TL BC
Fragranite
p. 71



MRG 110-37 BC
Fragranite
p. 73



MRG 210-37 BC
Fragranite
p. 73



MRG 610-37 TL
Fragranite
p. 74



MRG 110-37
Fragranite
p. 78



MRG 210-37
Fragranite
p. 79



SID 610-40
Tectonite
p. 87



SID 110-34
Tectonite
p. 87

Productos Standalone



FSS 110-15
Solid Surface
p. 90



FSS - 110 - 25
Solid Surface
p. 90



FSS - 110 - 33
Solid Surface
p. 90



FSS - 110 - 40
Solid Surface
p. 90



FSS - 110 - 45
Solid Surface
p. 91

Mueble de 60 cm



KNG 110-52
Fragranite
p. 67



KBK 110-50
Fraceram
p. 61



KBK 160
Fraceram
p. 61



MRG 610-52 TL
Fragranite
p. 71



MRG 110-52 BC
Fragranite
p. 72



MRG 210-52 BC
Fragranite
p. 73



MRG 610-52 TL
Fragranite
p. 74



MRG 610-52
Fragranite
p. 77



MRG 110-52
Fragranite
p. 78



MRG 210-52
Fragranite
p. 78



UBG 610-56
Fragranite
p. 81



SID 610-50
Tectonite
p. 85



SID 110-50
Tectonite
p. 86



SID 160
Tectonite
p. 86



BAK 710
Cerámico
p. 63



FSS - 110 - 50
Solid Surface
p. 91

Mueble de 70 cm



MRG 110-62
Fragranite
p. 77



MRG 210-62
Fragranite
p. 77



FSS - 110 - 60
Solid Surface
p. 91

Mueble de 80 cm



KNG 110-62
Fragranite
p. 67



KNG 120
Fragranite
p. 67



KBK 110-70
Fraceram
p. 61



MRG 610-72 TL
Fragranite
p. 71



MRG 110-72 BC
Fragranite
p. 72



MRG 210-72 BC
Fragranite
p. 72



MRG 610-72
Fragranite
p. 76



MRG 110-72
Fragranite
p. 76



MRG 210-72
Fragranite
p. 76



MRG 120
Fragranite
p. 75



MRG 220
Fragranite
p. 75



UBG 610-78
Fragranite
p. 81



S2D 620-86
Tectonite
p. 85



FSS - 110 - 70
Solid Surface
p. 91



BAK 720
Cerámico
p. 63

Mueble de 90 cm

Cubetas

Fregaderos

Grifos

Campanas

Electrodomésticos

Gestión de residuos

Accesorios

Accesorios

Gestión de residuos

Electrodomésticos

Campanas

Grifos

Fregaderos

Cubetas

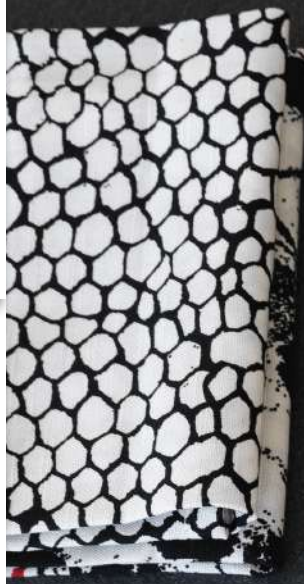



Cubetas Fraceram

60
62

Kubus
Belfast

Cubetas

Fregaderos

Grifos

Campanas

Electrodomésticos

Gestión de residuos

Accesorios

Kubus



Accesorios opcionales

38



Roll-up 468 x 420 mm
 Escurreidor enrollable
 112.0030.882
 7612142241574
80 €

34



Escurreidor móvil
342x430x22 mm
 Escurreidor móvil
 112.0188.651
 7612980584215
108 €

60 Colección 2023

MYTHOS



38

34

15
AÑOS
GARANTÍA



KUBUS
KBK 110-70*



Mueble: 80 cm
Instalación: **Bajo encimera**
Material: **Fraceram®**
Totales: **745 x 445; R30 mm**
Cubeta: **705 x 385 x 200; R15 mm**
Bajo encimera: **695 x 375; R15 mm**

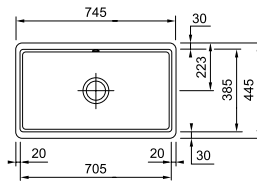

Onyx
126.0491.953
7612981908515
1.073 €

Blanco Polar
126.0491.920
7612981908485
1.073 €

MYTHOS



38

34

15
AÑOS
GARANTÍA



KUBUS
KBK 110-50*



Mueble: 60 cm
Instalación: **Bajo encimera**
Material: **Fraceram®**
Totales: **545 x 445; R30 mm**
Cubeta: **505 x 385 x 185; R15 mm**
Bajo encimera: **495 x 375; R15 mm**

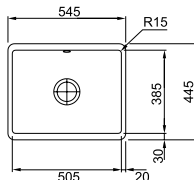

Onyx
126.0373.963
7612981603120
854 €

Blanco Polar
126.0371.145
7612981587987
854 €

MYTHOS



38

34

15
AÑOS
GARANTÍA



KUBUS
KBK 110-40*



Mueble: 55 cm
Instalación: **Bajo encimera**
Material: **Fraceram®**
Totales: **445 x 445; R30 mm**
Cubeta: **405 x 385 x 180; R15 mm**
Bajo encimera: **395 x 375; R15 mm**

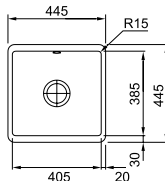

Onyx
126.0335.878
7612981287306
761 €

Blanco Polar
126.0335.711
7612981286385
761 €

MYTHOS



38

34

15
AÑOS
GARANTÍA



KUBUS
KBK 160*



Mueble: 60 cm
Instalación: **Bajo encimera**
Material: **Fraceram®**
Totales: **545 x 445; R30 mm**
Cubetas: **375 x 385 x 190; R15 mm/115 x 385 x 120 mm**
Bajo encimera: **495 x 375; R15 mm**

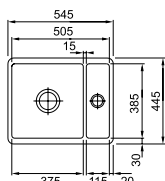

Onyx
126.0373.835
7612981602635
946 €

Blanco Polar
126.0371.141
7612981587949
946 €

*Se recomienda realizar el corte con la cubeta in situ.

Belfast





15
AÑOS
GARANTÍA

Mueble: **80 cm**
 Instalación: **Sobre bastidor**
 Material: **Cerámico**
 Totales: **800 x 500 x 220 mm**
 Cubetas: **362 x 450 x 200 mm**

BELFAST
BAK 720*
130.0085.740
 7612315075784
704 €

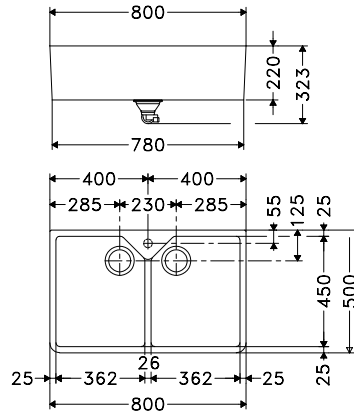

15
AÑOS
GARANTÍA

Mueble: **60 cm**
 Instalación: **Sobre bastidor**
 Material: **Cerámico**
 Totales: **595 x 475 x 225 mm**
 Cubeta: **445 x 410 x 225 mm**

BELFAST
BAK 710*
130.0085.739
 7612315075777
449 €

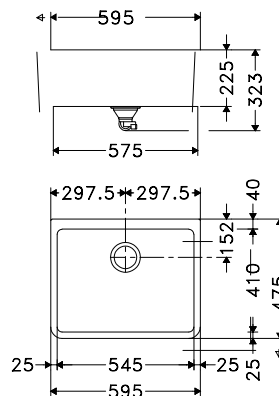
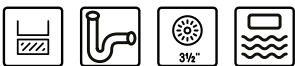

*NOTA DE INSTALACIÓN. Debido a la naturaleza del proceso de fabricación de la cerámica, cada cubeta producida variará dimensionalmente. Por esta razón, no se proporcionan plantillas. Para asegurar un ajuste apropiado entre la cubeta, el armario y cualquier marco de apoyo, Franke recomienda que se facilite al ebanista la propia cubeta para ser instalada.



FRA
GRA
NITE

Cubetas Fra granite

66

Kubus

68

Maris

80

Urban



Cubetas

Fregaderos

Grifos

Campanas

Electrodomésticos

Gestión de residuos

Accesorios

Kubus



Accesorios opcionales

22



Cubetilla inox
156x417x54mm R12.5
 Cubetilla
 112.0066.060
 7612980052851
122 €

40



Roll-up 298 x 410mm
 Escurreidor enrollable
 112.0256.867
 7612980897384
57 €

49



Tabla de corte nuez
442 x 230 x 23 mm
 Tabla de corte
 112.0654.748
 7612986081176
80 €

MYTHOS

22

40

49

5 AÑOS GARANTÍA



KUBUS 2 KNG 110-62

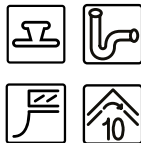

Mueble: 80 cm
Instalación: **Bajo encimera**
Material: **Fragranite**
Totales: **760 x 460; R10 mm**
Cubeta: **620 x 420 x 200; R10 mm**
Bajo encimera: **720 x 420; R10 mm**

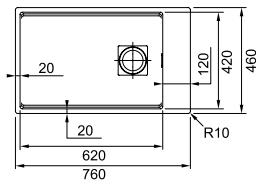

Onyx*
125.0527.562
7612985467643
600 €

Blanco Polar
125.0527.565
7612985467674
600 €

Negro mate
125.0633.509
7612985934992
600 €

Oyster*
125.0527.563
7612985467650
600 €

Stone*
125.0527.566
7612985467681
600 €

Café creme*
125.0527.456
7612985467636
600 €

MYTHOS

22

40

49

5 AÑOS GARANTÍA



KUBUS 2 KNG 110-52



Mueble: 60 cm
Instalación: **Bajo encimera**
Material: **Fragranite**
Totales: **560 x 460; R10 mm**
Cubeta: **520 x 420 x 200; R10 mm**
Bajo encimera: **520 x 420; R10 mm**

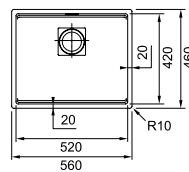

Onyx
125.0527.396
7612985467742
507 €

Blanco Polar
125.0527.399
7612985467773
507 €

Negro mate
125.0633.508
7612985934985
507 €

Oyster*
125.0527.397
7612985467759
507 €

Stone*
125.0527.400
7612985467780
507 €

Café creme*
125.0527.395
7612985467735
507 €

MYTHOS

22

40

49

5 AÑOS GARANTÍA



KUBUS 2 KNG 110-37



Mueble: 45 cm
Instalación: **Bajo encimera**
Material: **Fragranite**
Totales: **410 x 460; R10 mm**
Cubeta: **370 x 420 x 200; R10 mm**
Bajo encimera: **370 x 420; R10 mm**

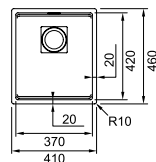

Onyx
125.0527.368
7612985467360
484 €

Blanco Polar
125.0527.391
7612985467391
484 €

Negro mate
125.0633.507
7612985934978
484 €

Oyster
125.0527.369
7612985467377
484 €

Stone*
125.0527.392
7612985467704
484 €

Café creme*
125.0527.367
7612985467353
484 €

MYTHOS

22

40

49

5 AÑOS GARANTÍA



KUBUS 2 KNG 120



Mueble: 80 cm
Instalación: **Bajo encimera**
Material: **Fragranite**
Totales: **760 x 460; R10 mm**
Cubetas: **460 x 420 x 200; R10 mm**
420 x 210 x 200 mm
Bajo encimera: **720 x 420 mm R10**

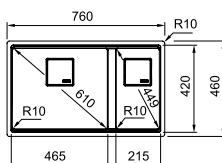

Onyx*
125.0527.573
7612985468121
646 €

Blanco Polar*
125.0527.576
7612985468152
646 €

Negro mate
125.0633.510
7612985935005
646 €

Oyster*
125.0527.574
7612985468138
646 €

Stone*
125.0527.577
7612985468169
646 €

Café creme*
125.0527.572
7612985468114
646 €

* Bajo demanda

Cubetas Maris Fragranite

Espectacularmente grande



Una cubeta que satisface todas las necesidades

Los invitados están por llegar, la cena esta lista y el show está por comenzar, pero necesitas un espacio para dejar ir tu creatividad y organizarte. Es ahí cuando las cubetas Maris Fraganite acuden al rescate. Es tan espectacularmente grande que puedes fácilmente limpiar hasta las bandejas del horno. Además, están fabricadas con nuestro material exclusivo, Fraganite, un material que es duradero, resistente al calor e higiénico.



Cubetas

Fregaderos

A juego con tu cocina

Las cubetas Maris Fraganite son la opción ideal para tu cocina. Ofrecen un aspecto moderno con mucho más espacio, combinando su diseño y comodidad a la hora de preparar tus alimentos y limpiar los utensilios de cocina.



Diseño moderno y sofisticado

Nuestras cubetas tienen un diseño minimalista, lo que permite que se integren perfectamente en tu cocina. Con su borde extremadamente fino, se posicionan como una de las cubetas más llamativas del mercado. Además, algunos modelos incluyen un embellecedor y un rebosadero oculto.

Grifos

Campanas



Larga duración

Las cubetas incluyen cuarzo en su composición, uno de los materiales más robustos conocidos por el hombre, y es resistente a temperaturas de hasta 280°C. También es resistente a los impactos y arañazos.

Electrodomésticos

Higiene superior

Nuestras cubetas son fáciles de limpiar y especialmente higiénicas pues cuentan con el aditivo Sanitized, un material que contienen iones de plata que reducen el crecimiento de bacterias y microbios en un 99%.



Gestión de residuos

Accesorios

Maris



Accesorios opcionales

11



All-In
**Guia-cubetilla-
 placa corte**
 Accesorios All -In
 112.0655.481
 7612986084603
138 €

12



All-In
**Guia-bolx2-
 placa de corte**
 Accesorios All -In
 112.0655.482
 7612986084610
161 €

13



All-In
**Guia-cubetilla-
 Placa corte-
 escurridor**
 Accesorios All -In
 112.0655.483
 7612986084627
195 €

14



All-In
**Guia-bolx2-
 placa corte-
 escurridor**
 Accesorios All -In
 112.0655.488
 7612986084641
207 €

15



All-In
Full set
 Accesorios All -In
 112.0655.489
 7612986084658
253 €

38



Roll-up
468 x 420 mm
 Escurridor
 enrollable
 112.0030.882
 76121422241574
80 €

34



Escurridor
movil
342x430x22 mm
 Escurridor móvil
 112.0188.651
 7612980584215
108 €

MARIS

- 11
- 12
- 13
- 14
- 15
- 34
- 38



Mueble: **80 cm**
 Instalación: **Encastre**
 Material: **Fragranite**
 Totales: **760 x 510; R 15 mm**
 Cubeta: **720 x 400 x 200; R 20 mm**
 Encastre: **740 x 498; R 15 mm**

Negro mate

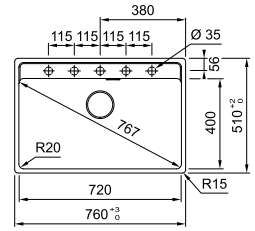

MARIS BLACK COLLECTION
MRG 610-72 TL
114.0659.125
 7612986097474
600€



5
 AÑOS
 GARANTÍA

Cubetas

Fregaderos

Grifos

MARIS

- 11
- 12
- 13
- 14
- 15



Mueble: **60 cm**
 Instalación: **Encastre**
 Material: **Fragranite**
 Totales: **560 x 510; R 15 mm**
 Cubeta: **520 x 400 x 200; R 20 mm**
 Encastre: **540 x 498; R 15 mm**

Negro mate

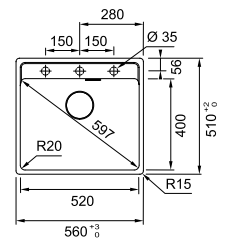

MARIS BLACK COLLECTION
MRG 610-52 TL
114.0659.124
 7612986097467
542€



5
 AÑOS
 GARANTÍA

Campanas

Electrodomésticos

MARIS

- 11
- 12
- 13
- 14
- 15



Mueble: **45 cm**
 Instalación: **Encastre**
 Material: **Fragranite**
 Totales: **410 x 510; R 15 mm**
 Cubeta: **370 x 400 x 200; R 20 mm**
 Encastre: **390 x 500 mm**

Negro mate

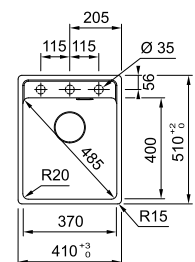

MARIS BLACK COLLECTION
MRG 610-37 TL
114.0659.123
 7612986097450
519 €



5
 AÑOS
 GARANTÍA

Gestión de residuos

Accesorios

MARIS

11

12

13

14

15

34

38



Mueble: **80 cm**
 Instalación: **Bajo encimera**
 Material: **Fragranite**
 Totales: **753 x 433; R 15 mm**
 Cubeta: **720 x 400 x 200; R 20 mm**
 Bajo encimera: **720 x 400; R 20 mm**

Negro mate
5
 AÑOS
 GARANTÍA

MARIS BLACK COLLECTION
MRG 110-72
125.0683.236
7612986238136
576 €

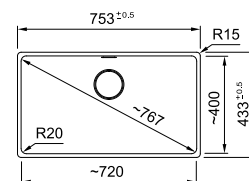

MARIS

11

12

13

14

15

34

38



Mueble: **80 cm**
 Instalación: **A ras**
 Material: **Fragranite**
 Totales: **753 x 433; R 15 mm**
 Cubeta: **720 x 400 x 200; R 20 mm**

Negro mate
5
 AÑOS
 GARANTÍA

MARIS BLACK COLLECTION
MRG 210-72
135.0683.052
7612986237184
576 €

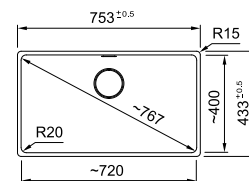

MARIS

11

12

13

14

15

34

38



Mueble: **60 cm**
 Instalación: **Bajo encimera**
 Material: **Fragranite**
 Totales: **553 x 433; R 15 mm**
 Cubeta: **520 x 400 x 200; R 20 mm**
 Bajo encimera: **520 x 400; R 20 mm**

Negro mate
5
 AÑOS
 GARANTÍA

MARIS BLACK COLLECTION
MRG 110-52
125.0683.234
7612986238112
473 €

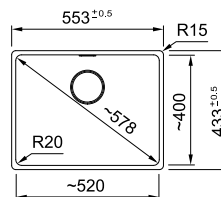

MARIS

- 11
- 12
- 13
- 14
- 15
- 34
- 38

NEW



Mueble: **60 cm**
 Instalación: **A ras**
 Material: **Fragranite**
 Totales: **553 x 433; R 15 mm**
 Cubeta: **520 x 400 x 200; R 20 mm**

5
 AÑOS
 GARANTÍA

MARIS BLACK COLLECTION
MRG 210-52
135.0683.051
7612986237177
473 €



 **Negro mate**

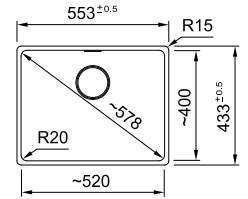

Cubetas

Fregaderos

Girfos

MARIS

- 11
- 12
- 13
- 14
- 15
- 34
- 38

NEW



Mueble: **45 cm**
 Instalación: **Bajo encimera**
 Material: **Fragranite**
 Totales: **403 x 433; R 15 mm**
 Cubeta: **370 x 400 x 200; R 20 mm**
 Bajo encimera: **370 x 400; R 20 mm**

5
 AÑOS
 GARANTÍA

MARIS BLACK COLLECTION
MRG 110-37
125.0683.232
7612986238099
449 €



 **Negro mate**

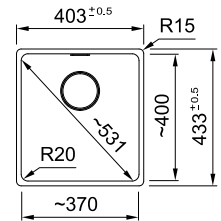

Campanas

Electrodomesticos

MARIS

- 11
- 12
- 13
- 14
- 15
- 34
- 38

NEW



Mueble: **45 cm**
 Instalación: **A ras**
 Material: **Fragranite**
 Totales: **403 x 433; R 15 mm**
 Cubeta: **370 x 400 x 200; R 20 mm**

5
 AÑOS
 GARANTÍA

MARIS BLACK COLLECTION
MRG 210-37
135.0683.050
7612986237160
449 €



 **Negro mate**

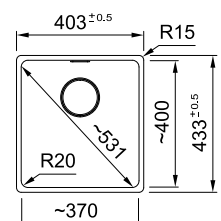

Gestión de residuos

Accesorios

MARIS

- 11
- 12
- 13
- 14
- 15
- 34
- 38



Mueble: 80 cm
 Instalación: **Encastre**
 Material: **Fragranite**
 Totales: 760 x 510; R 15 mm
 Cubeta: 720 x 400 x 200; R 20 mm
 Encastre: 740 x 498; R 15 mm

- | | |
|--|--|
| <p>Onyx
 114.0658.303
 7612986093445
 565 €</p> <p>Blanco Polar
 114.0658.308
 7612986093483
 565 €</p> <p>Negro mate
 114.0658.305
 7612986093469
 565 €</p> | <p>Oyster
 114.0658.309
 7612986093490
 565 €</p> <p>Stone
 114.0658.306
 7612986093476
 565 €</p> |
|--|--|

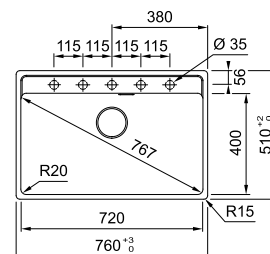

5
AÑOS
GARANTÍA

MARIS
MRG 610-72 TL



MARIS

- 11
- 12
- 13
- 14
- 15
- 34
- 38



Mueble: 60 cm
 Instalación: **Encastre**
 Material: **Fragranite**
 Totales: 560 x 510; R 15 mm
 Cubeta: 520 x 400 x 200; R 20 mm
 Encastre: 540 x 498; R 15 mm

- | | |
|--|--|
| <p>Onyx
 114.0658.293
 7612986093346
 484 €</p> <p>Blanco Polar
 114.0658.296
 7612986093377
 484 €</p> <p>Negro mate
 114.0658.294
 7612986093353
 484 €</p> | <p>Oyster
 114.0658.297
 7612986093384
 484 €</p> <p>Stone
 114.0658.295
 7612986093360
 484 €</p> |
|--|--|

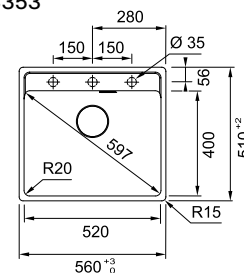

5
AÑOS
GARANTÍA

MARIS
MRG 610-52 TL



MARIS

- 11
- 12
- 13
- 14
- 15
- 34



Mueble: 45 cm
 Instalación: **Encastre**
 Material: **Fragranite**
 Totales: 410 x 510; R 15 mm
 Cubeta: 370 x 400 x 200; R 20 mm
 Encastre: 390 x 498; R 15 mm

- | | |
|--|--|
| <p>Onyx
 114.0658.140
 7612986092875
 461 €</p> <p>Blanco Polar
 114.0658.256
 7612986093223
 461 €</p> <p>Negro mate
 114.0658.254
 7612986093209
 461 €</p> | <p>Oyster
 114.0658.257
 7612986093230
 461 €</p> <p>Stone
 114.0658.255
 7612986093216
 461 €</p> |
|--|--|

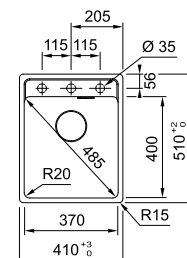

5
AÑOS
GARANTÍA

MARIS
MRG 610-37 TL



MARIS

- 11
- 12
- 13
- 14
- 15
- 34
- 38

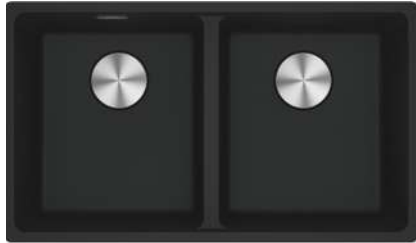

Mueble: 80 cm
 Instalación: **Encastre**
 Material: **Fragranite**
 Totales: 760 x 440; R15 mm
 Cubeta: 346 x 400 x 200; R20 mm
 Encastre: 740 x 428; R15 mm

- Negro mate**
 114.0661.682
 7612986113273
 565 €
- Blanco Polar**
 114.0661.686
 7612986113310
 565 €
- Café creme**
 114.0661.687
 7612986113327
 565 €

5
 AÑOS
 GARANTÍA

MARIS
 MRG 620-35-35

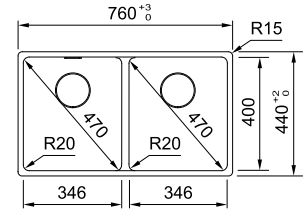
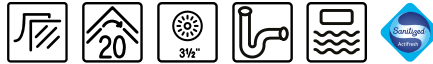

MARIS

- 11
- 12
- 13
- 14
- 15
- 34

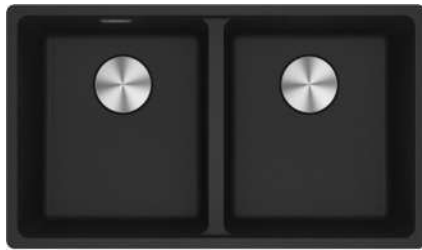

Mueble: 80 cm
 Instalación: **Bajo encimera**
 Material: **Fragranite**
 Totales: 753 x 433; R 15 mm
 Cubeta:
 346 x 400 x 200; R 20 mm
 346 x 400 x 200
 Bajo encimera: 720 x 400; R 20

- Onyx**
 125.0692.053
 7612986282986
 507 €
- Stone**
 125.0692.052
 7612986282979
 507 €
- Blanco Polar**
 125.0692.039
 7612986282948
 507 €
- Café creme**
 125.0692.040
 7612986282955
 507 €
- Negro mate**
 125.0692.054
 7612986282993
 507 €
- Platinum**
 125.0692.051
 7612986282962
 507 €

5
 AÑOS
 GARANTÍA

MARIS
 MRG 120

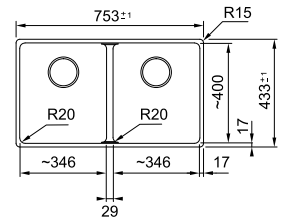

MARIS

- 11
- 12
- 13
- 14
- 15
- 34



Mueble: 80 cm
 Instalación: **A ras**
 Material: **Fragranite**
 Totales: 753 x 433; R 15 mm
 Cubeta:
 346 x 400 x 200; R 20 mm
 346 x 400 x 200

- Onyx**
 135.0694.635
 7612986303247
 507 €
- Stone**
 135.0694.636
 7612986303254
 507 €
- Blanco Polar**
 135.0694.637
 7612986303261
 507 €
- Negro mate**
 135.0694.634
 7612986303230
 507 €

5
 AÑOS
 GARANTÍA

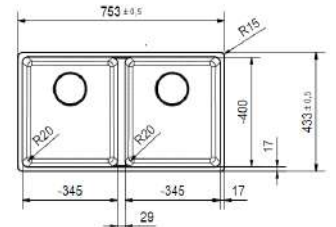

MARIS
 MRG 220



MARIS

11
12
13
14
15
34

Mueble: **80 cm**
 Instalación: **Encastre**
 Material: **Fragranite**
 Totales: **760 x 440; R 15 mm**
 Cubeta: **720 x 400 x 200; R 20 mm**
 Encastre: **740 x 428; R 15 mm**

-  **Negro mate**
114.0661.650
7612986112955
542 €
-  **Blanco Polar**
114.0661.654
7612986112993
542 €
-  **Café creme**
114.0661.655
7612986113006
542 €

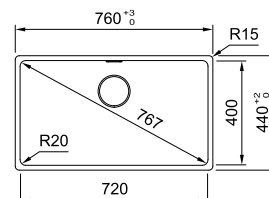

5
AÑOS
GARANTÍA

MARIS
MRG 610-72



MARIS

11
12
13
14
15
34

Mueble: **80 cm**
 Instalación: **Bajo encimera**
 Material: **Fragranite**
 Totales: **753 x 433; R 15 mm**
 Cubeta: **720 x 400 x 200; R 20 mm**
 Bajo encimera: **720 x 400; R 20 mm**

-  **Onyx**
125.0692.020
7612986282801
519 €
-  **Blanco Polar**
125.0692.016
7612986282764
519 €
-  **Negro mate**
125.0692.021
7612986282818
519 €
-  **Platinum**
125.0692.018
7612986282788
519 €
-  **Stone**
125.0692.019
7612986282795
519 €
-  **Café creme**
125.0692.017
7612986282771
519 €

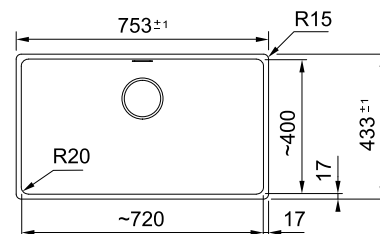

5
AÑOS
GARANTÍA





MARIS
MRG 110-72



MARIS

11
12
13
14
15
34

Mueble: **80 cm**
 Instalación: **A ras**
 Material: **Fragranite**
 Totales: **753 x 433; R 15 mm**
 Cubeta: **720 x 400 x 200; R 20 mm**

-  **Stone**
135.0683.024
7612986236903
519 €
-  **Onyx**
135.0683.023
7612986236897
519 €
-  **Blanco Polar**
135.0691.632
7612986281002
519 €
-  **Negro mate**
135.0691.633
7612986281019
519 €

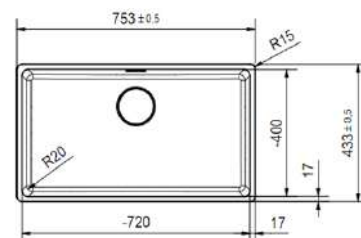

5
AÑOS
GARANTÍA

MARIS
MRG 210-72



MARIS

- 11
- 12
- 13
- 14
- 15
- 34



5
AÑOS
GARANTÍA

MARIS
MRG 110-62

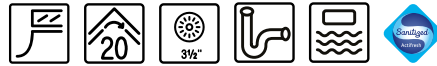

Mueble: **70 cm**
 Instalación: **Bajo encimera**
 Material: **Fragranite**
 Totales: **653 x 433; R15 mm**
 Cubeta: **620 x 400; R20 mm**
 Bajo encimera: **620 x 400; R20 mm**

- | | |
|---|---|
| <p>Onyx
125.0692.001
7612986282573
479 €</p> <p>Blanco Polar
125.0691.997
7612986282535
479 €</p> <p>Negro mate
125.0692.002
7612986282580
479 €</p> | <p>Platinum
125.0691.999
761298628 2559
479 €</p> <p>Stone
125.0692.000
7612986282566
479 €</p> <p>Café creme
125.0691.998
7612986282542
479 €</p> |
|---|---|

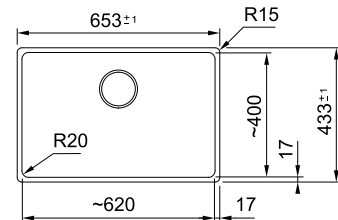

MARIS

- 11
- 12
- 13
- 14
- 15
- 34



5
AÑOS
GARANTÍA

MARIS
MRG 210-62



Mueble: **70 cm**
 Instalación: **A ras**
 Material: **Fragranite**
 Totales: **653 x 433; R15 mm**
 Cubeta: **620 x 400 x 200; R20 mm**

- | | |
|---|--|
| <p>Onyx
135.0696.964
7612986313154
479 €</p> <p>Blanco Polar
135.0696.966
7612986313178
479 €</p> | <p>Negro mate
135.0696.968
7612986313192
479 €</p> <p>Oyster
135.0696.967
7612986313185
479 €</p> <p>Stone
135.0696.965
7612986313161
479 €</p> |
|---|--|

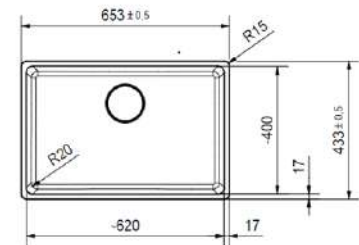

MARIS

- 11
- 12
- 13
- 14
- 15
- 34



MARIS
MRG 610-52



Mueble: **60 cm**
 Instalación: **Encastre**
 Material: **Fragranite**
 Totales: **560 x 440; R 15 mm**
 Cubeta: **520 x 400 x 200; R 20 mm**
 Encastre: **540 x 428; R 15 mm**

- | |
|---|
| <p>Negro mate
114.0661.658
7612986113037
449 €</p> <p>Blanco Polar
114.0661.662
7612986113075
449 €</p> <p>Café creme
114.0661.663
7612986113082
449 €</p> |
|---|

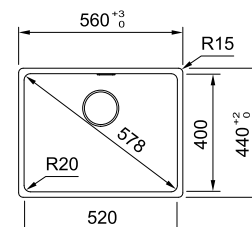

5
AÑOS
GARANTÍA

Cubetas

Fregaderos

Girfos

Campanas

Electrodomésticos

Gestión de residuos

Accesorios

MARIS

- 11
- 12
- 13
- 14
- 15
- 34



Mueble: **60 cm**
 Instalación: **Bajo encimera**
 Material: **Fragranite**
 Totales: **553 x 433; R 15 mm**
 Cubeta: **520 x 400 x 200; R 20 mm**
 Bajo encimera: **554,5 x 434,5; R 20 mm**

- | | |
|--|--|
| <p>Onyx
 125.0691.990
 7612986282399
 415 €</p> | <p>Platinum
 125.0691.988
 7612986282375
 415 €</p> |
| <p>Blanco Polar
 125.0691.986
 7612986282351
 415 €</p> | <p>Stone
 125.0691.989
 7612986282382
 415 €</p> |
| <p>Negro mate
 125.0690.518
 7612986276602
 415 €</p> | <p>Café creme
 125.0691.987
 7612986282368
 415 €</p> |

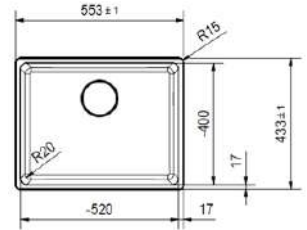

MARIS
MRG 110-52

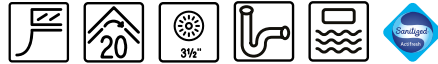

MARIS

- 11
- 12
- 13
- 14
- 15
- 34



Mueble: **60 cm**
 Instalación: **A ras**
 Material: **Fragranite**
 Totales: **553 x 433; R 15 mm**
 Cubeta: **520 x 400 x 200; R 20 mm**

- | | |
|--|--|
| <p>Stone
 135.0682.989
 7612986236859
 415 €</p> | <p>Onyx
 135.0682.988
 7612986236842
 415 €</p> |
| <p>Blanco Polar
 135.0691.504
 7612986280746
 415 €</p> | <p>Negro mate
 135.0691.505
 7612986280753
 415 €</p> |

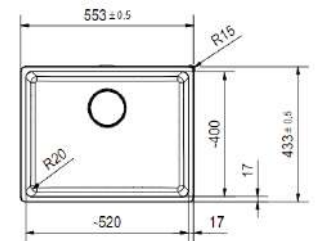

MARIS
MRG 210-52



MARIS

- 11
- 12
- 13
- 14
- 15
- 34



Mueble: **45 cm**
 Instalación: **Bajo encimera**
 Material: **Fragranite**
 Totales: **403 x 433; R 15 mm**
 Cubeta: **370 x 400 x 200; R 20 mm**
 Bajo encimera: **370 x 400; R 20 mm**

- | | |
|--|--|
| <p>Onyx
 125.0691.979
 7612986282283
 392 €</p> | <p>Platinum
 125.0691.977
 7612986282269
 392 €</p> |
| <p>Blanco Polar
 125.0691.975
 7612986282245
 392 €</p> | <p>Stone
 125.0691.978
 7612986282276
 392 €</p> |
| <p>Negro mate
 125.0691.980
 7612986282290
 392 €</p> | <p>Café creme
 125.0691.976
 7612986282252
 392 €</p> |

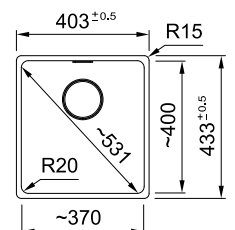

MARIS
MRG 110-37



MARIS

11

12

13

14

15

34



Mueble: 45 cm
Instalación: A ras
Material: **Fragranite**
Totales: 403 x 433; R 15 mm
Cubeta: 370 x 400 x 200; R 20 mm



Stone
135.0682.983
7612986236804
392 €



Onyx
135.0682.982
7612986236699
392 €



Blanco Polar
135.0682.984
7612986236811
392 €



Negro mate
135.0682.986
7612986236835
392 €

5
AÑOS
GARANTÍA

MARIS
MRG 210-37

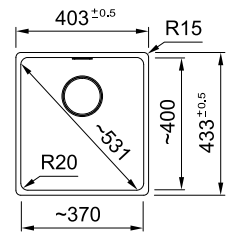

Cubetas

Fregaderos

Girifos

Campanas

Electrodomésticos

Gestión de residuos

Accesorios

Urban



Accesorios

47



**Tabla de corte
Bambú 280x532**
Tabla de corte
112.0595.334
7612985746939
57 €

29



**Escurreidor gris Urban
440x181x92mm***
Escurreidor
112.0538.950
7612985514781
23 €

80 Colección 2023

MARIS

47

29

5 AÑOS GARANTÍA



Mueble: 90 cm
Instalación: Encastre
Material: **Fragranite**
Totales: 860 x 500 mm R15
Cubetas:
432 x 425 x 230; R15 mm
341 x 364 x 220 mm
Encastre: 824 x 464; R15 mm

- Onyx**
114.0686.775
7612986253900
426 €
- Blanco Polar***
114.0686.768
7612986253832
426 €
- Negro mate**
114.0686.774
7612986253894
426 €

- Platinum***
114.0686.771
7612986253863
426 €
- Stone***
114.0686.773
7612986253887
426 €
- Café creme**
114.0686.769
7612986253849
426 €

URBAN
UBG 620-86

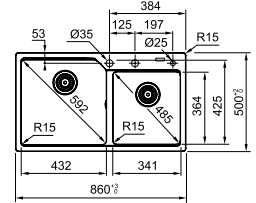

MARIS

47

29

5 AÑOS GARANTÍA



Mueble: 80 cm
Instalación: Encastre
Material: **Fragranite**
Totales: 780 x 500; R15 mm
Cubeta: 723 x 425 x 230; R15 mm
Encastre: 760 x 480; R15 mm

- Onyx**
114.0697.772
7612986317183
376 €
- Blanco Polar**
114.0697.773
7612986317190
376 €
- Negro mate**
114.0697.771
7612986317176
376 €

- Stone***
114.0697.774
7612986317404
376 €
- Oyster***
114.0697.780
7612986317466
376 €

URBAN
UBG 610-72

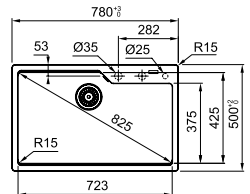

MARIS

47

29

5 AÑOS GARANTÍA



Mueble: 60 cm
Instalación: Encastre
Material: **Fragranite**
Totales: 560 x 500; R15 mm
Cubeta: 503 x 425 x 230; R15 mm
Encastre: 540 x 480; R15 mm

- Onyx**
114.0697.776
7612986317428
322 €
- Blanco Polar**
114.0697.777
7612986317435
322 €
- Negro mate***
114.0697.775
7612986317411
322 €
- Platinum***
114.0697.779
7612986317459
322 €

- Stone***
114.0697.778
7612986317442
322 €
- Oyster***
114.0697.781
7612986317473
322 €
- Café creme**
114.0697.782
7612986317480
322 €

URBAN
UBG 610-50

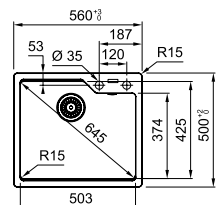

* Bajo demanda

Cubetas

Fregaderos

Grifos

Campanas

Electrodomésticos

Gestión de residuos

Accesorios





TEC
TON
ITE

Cubetas Tectonite

84

Sirius

Sirius



Accesorios opcionales

11



All-In
Guia-cubetilla-
placa corte

Accesorios All -In
 112.0655.481
 7612986084603
138 €

12



All-In
Guia-bolx2-
placa de corte

Accesorios All -In
 112.0655.482
 7612986084610
161 €

34



Escurreidor
movil
342x430x22
 Escurreidor móvil
 112.0188.651
 7612980584215
108 €

SMART

11

12



5
AÑOS
GARANTÍA

Mueble: **80 cm**
Instalación: **Encastre**
Material: **Tectonite**
Totales: **860 x 500 mm R8**
Cubetas: **350 x 400 x 200; R10 mm**
350 x 400 x 200 mm
Encastre: **844 x 484; R7,5 mm**

Carbone
143.0639.588
7612985963947
376 €

Blanco polar
143.0639.586
7612985963923
376 €

SIRIUS 2
S2D 620-86

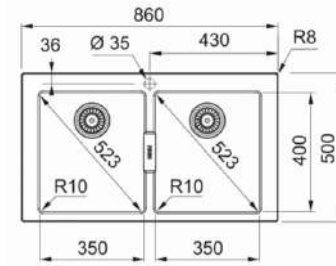

SMART

11

12



5
AÑOS
GARANTÍA

Mueble: **60 cm**
Instalación: **Encastre**
Material: **Tectonite**
Totales: **560 x 530; R10 mm**
Cubeta: **490 x 370 x 200; R10 mm**
Encastre: **544 x 514; R7,5 mm**
Con orificio de grifo centrado

Carbone
114.0361.524
7612981533243
237 €

Blanco polar
114.0361.522
7612981533229
237 €

SIRIUS
SID 610-50

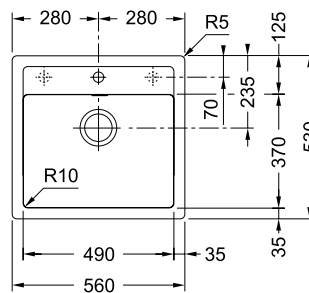

SMART

34

11

12

5
AÑOS
GARANTÍA

Mueble: **60 cm**
 Instalación: **Bajo encimera**
 Material: **Tectonite**
 Totales: **525 x 440; R10 mm**
 Cubeta: **500 x 410 x 200; R10 mm**
 Bajo encimera: **500 x 410 mm x R10**

Carbone
125.0332.322
 7612981269036
295 €

Blanco polar
125.0332.323
 7612981269043
295 €

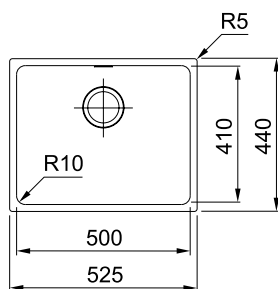
SIRIUS
SID 110-50

SMART

34

11

12

5
AÑOS
GARANTÍA

Mueble: **60 cm**
 Instalación: **Bajo encimera**
 Material: **Tectonite**
 Totales: **560 x 440; R10 mm**
 Cubeta: **340 x 410 x 200; R10 mm**
160 x 410 x 140 mm
 Bajo encimera: **535 x 410; R10mm**

Carbone
125.0332.299
 7612981268503
322 €

Blanco polar
125.0332.300
 7612981269012
322 €

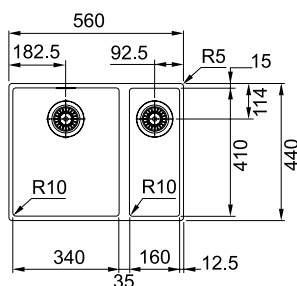
SIRIUS
SID 160

SMART

11
12



5
AÑOS
GARANTÍA

Mueble: **45 cm**
Instalación: **Encastre**
Material: **Tectonite**
Totales: **430 x 530; R8 mm**
Cubeta: **371 x 385 x 200; R10 mm**
Encastre: **410 x 510; R8 mm**
Con orificio de grifo centrado

Carbone
114.0501.901
7612985133067
214 €

Blanco polar
114.0501.903
7612985133081
214 €

SIRIUS
SID 610-40

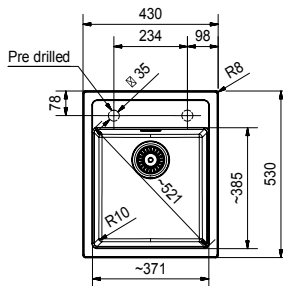

SMART

34
11
12



5
AÑOS
GARANTÍA

Mueble: **45 cm**
Instalación: **Bajo encimera**
Material: **Tectonite**
Totales: **365 x 440; R10 mm**
Cubeta: **340 x 410 x 200; R10 mm**
Bajo encimera: **340 x 410 mm x R10**

Carbone
125.0332.327
7612981269067
265 €

Blanco polar
125.0332.398
7612981268985
265 €

SIRIUS
SID 110-34

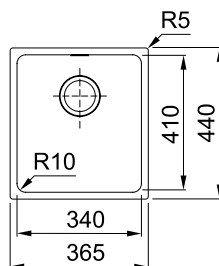

Cubetas

Fregaderos

Grifos

Campanas

Electrodomésticos

Gestión de residuos

Accesorios

Solid Surface



Cubetas

Fregaderos

Grifos

Campanas

Electrodomésticos

Gestión de residuos

Accesorios

Gama de colores

Color uniforme sólido



FSS - 101
Cándido



FSS - 120
Bianca



FSS - 102
Natural White



FSS - 103
Latte



FSS - 105
Amaretto

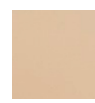

FSS - 121
Beige

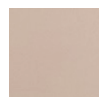

FSS - 124
Grigio



FSS - 221
Cacao



FSS - 126
Fumicato



FSS - 125
Liquore



FSS - 201
Rosso

Translúcido

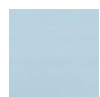

FSS - 923
Blu Luce



FSS - 922
Verde Luce

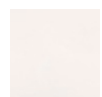

FSS - 925
Candido Luce



FSS - 921
Rosa Luce

Pigmentado



FSS - 301
Cristallo



FSS - 329
Noci



FSS - 302
Caffè



FSS - 327
Gelso



FSS - 331
Arachidi



FSS - 326
Biscotti



FSS - 303
Notte



FSS - 328
Albicocca



FSS - 304
Caramello



FSS - 332
Fichi



FSS - 330
Mandorle



FSS - 521
Lipari



FSS - 523
Corsica



FSS - 420
Mercuri



FSS - 402
Marmo



FSS - 421
Venere



FSS - 423
Saturno



FSS - 406
Avena

Veteado (imitación mármol)



FSS - 601
Negro/Blanco



FSS - 602
Blanco/Negro

Los colores representados en las imágenes pueden diferir de la realidad. Aconsejamos comprobar el color previamente.



Mueble: **30 cm**
 Instalación: **Bajo encimera**
 Totales: **240 x 450 x 160 mm**
 Cubeta: **190 x 400 x 140 mm; R 10 mm**

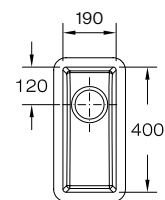

FSS 110-19
Cándido (blanco)
125.0328.044
 7612981017491
330 €



Mueble: **40 cm**
 Instalación: **Bajo encimera**
 Totales: **280 x 450 x 160 mm**
 Cubeta: **250 x 400 x 140 mm; R 10 mm**

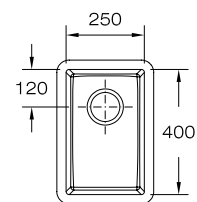

FSS - 110 - 25
Cándido (blanco)
125.0328.043
 7612981018955
366 €



Mueble: **45 cm**
 Instalación: **Bajo encimera**
 Totales: **380 x 450 x 190 mm**
 Cubeta: **330 x 400 x 170 mm; R 10 mm**

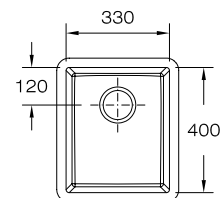

FSS - 110 - 33
Cándido (blanco)
125.0662.333
 7612986116571
392 €



Mueble: **50 cm**
 Instalación: **Bajo encimera**
 Totales: **450 x 450 x 195 mm**
 Cubeta: **400 x 400 x 170 mm; R 10 mm**

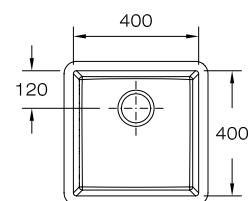

FSS - 110 - 40
Cándido (blanco)
125.0662.336
 7612986116588
423 €



Durante la instalación, las cubetas solid surface deben ser pulidas con una lija P350, con la intención de que se eviten las adherencias de suciedad y facilite su limpieza.



Mueble: **50 cm**
Instalación: **Bajo encimera**
Totales: **500 x 450 mm**
Cubeta: **450 x 400 x 165 mm; R 10 mm**

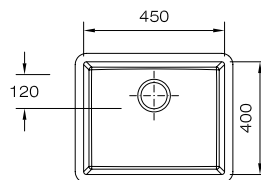

FSS - 110 - 45
Cándido (blanco)
125.0662.338
7612986116595
447 €



Mueble: **60 cm**
Instalación: **Bajo encimera**
Totales: **550 x 450 x 185 mm**
Cubeta: **500 x 400 x 170 mm**

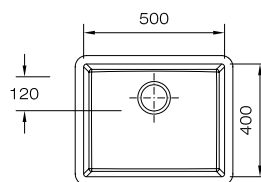

FSS - 110 - 50
Cándido (blanco)
125.0662.339
7612986117103
460 €



Mueble: **70 cm**
Instalación: **Bajo encimera**
Totales: **650 x 450 x 190 mm**
Cubeta: **600 x 400 x 170 mm; R 10 mm**

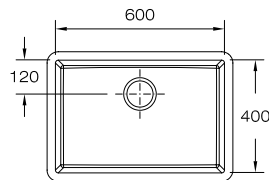

FSS - 110 - 60
Cándido (blanco)
125.0662.340
7612986117110
477 €



Mueble: **80 cm**
Instalación: **Bajo encimera**
Totales: **750 x 450 x 190 mm**
Cubeta: **700 x 400 x 170 mm**

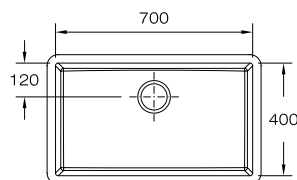

FSS - 110 - 70
Cándido (blanco)
125.0662.342
7612986117127
546 €



Cubetas

Fregaderos

Grifos

Campanas

Electrodomésticos

Gestión de residuos

Accesorios



Picto gramas

FRA GRA NITE

Composición de granito natural, garantiza durabilidad y robustez



Reversible

TEC TON ITE

Material altamente resistente de última tecnología, fabricado a partir de SMC (Sheet Moulding Compound) con revestimiento de PiMC



Radio de la Cubeta



Material extremadamente resistente, la cerámica Franke está hecha de una mezcla de arcilla y chamota, recubierta de un esmalte.



Sifón



Resistencia a la corrosión y soldadura (excluyendo la válvula)



Válvula automática con mando pulsable



Sanitized®: Tratamiento antibacteriano que reduce un 99% la proliferación de microbios y bacterias.



Válvula manual 3 1/2"



A ras: El orificio y rebaje debe realizarse basándose en las medidas/espesor del fregadero físico a enrasar. Este proceso debe ser ejecutado siempre por un profesional especializado.



Fijación Fast Fix



Encastre: El fregadero reposa sobre la encimera



Fregaderos con 2 orificios pre perforados Ø 35 mm



Instalación Bajo encimera



Conjunto rebosadero



Sobre bastidor



Nº de agujeros



Cubetas

Fregaderos

Grifos

Campanas

Electrodomésticos

Gestión de residuos

Accesorios

...LA ESPERANZA...
A HACER COSAS QUE A
DEJA DE VIVIR...
LA VIDA ES SIMPLE. CADA VEZ
...
VIAJA SEGURO...
...
LA VIDA ES VIVIR TU SUEÑO
LA VIDA ES VIVIR TU SUEÑO
CORTA. TU PASIÓN



Cubetas

Fregaderos

Grifos

Campanas

Electrodomésticos

Gestión de residuos

Accesorios

Fregade- ros Inox

98

100

104

Mythos

Maris

Smart

Fregaderos Inox

Cubetas

Fregaderos

Grifos

Campanas

Electrodomésticos

Gestión de residuos

Accesorios

Mueble de
45 cm

Mueble de
60 cm

MYTHOS

MARIS

SMART



SMART SRX 611-86 D/I
p. 105



MYTHOS MYX 211-86 TL D/I
p. 99



MYTHOS MYX 251-86 TL D/I
p. 99



MARIS MRX 211
p. 101



MARIS MRX 251
p. 101



ATON ANX 211-100 D/I
p. 102



ATON ANX 251 D/I
p. 102



SMART SRX 651 D/I
p. 105



SMART SRX 611 LB D/I
p. 105

Productos Standalone



ONDA LINE OLX 611 D/I
p. 106



COLIBRÍ CIN 611 D/I
p. 107



CIN-611 REV. 5/unidades
p. 107



SPARK SKX 611 L
p. 106

Mueble de
80 cm

Mueble de
80 - 90 cm



ARGOS AGX 210C IX
p. 103



ATON ANX 220
p. 103



SMART SRX 620
p. 105



ONDA LINE OLX-621 D/I
p. 106



ONDA LINE OLX 620-79 D/I
p. 106



COLIBRÍ CIN 620 D/I
p. 107



PROGRESSO ANGULAR PNX-621-E
p. 103

Cubetas

Fregaderos

Grifos

Campanas

Electrodomésticos

Gestión de residuos

Accesorios

Mythos

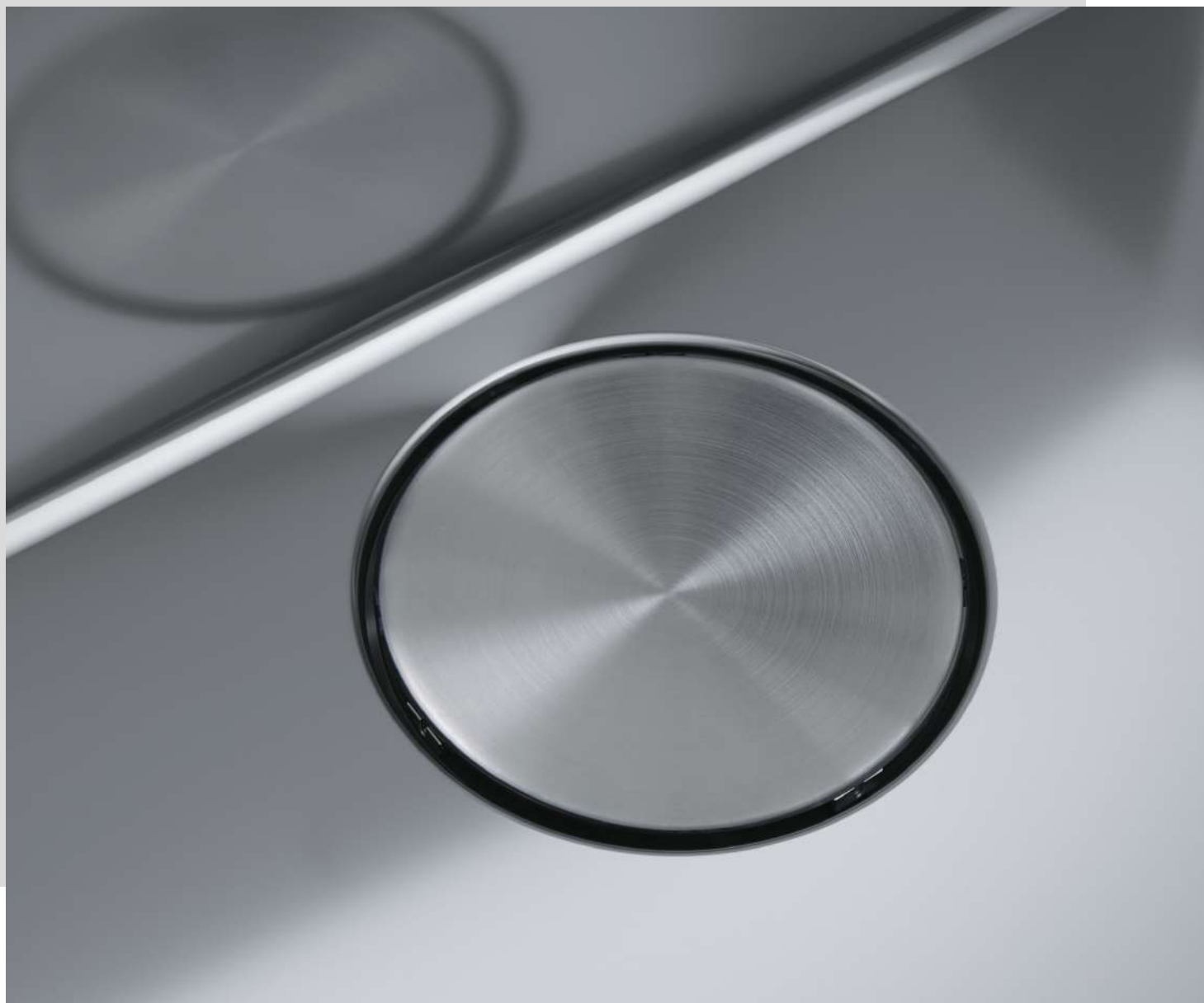

Accesorios incluidos

50



**Sifón salvaespacio
1 Vía salida 40mm**
Sifón
112.0048.206
7612319502767
19 €

51



**Sifón salvaespacio
2 Vías salida 40mm**
Sifón
112.0624.484
7612985884273
27 €

Accesorios opcionales

24



Cubetilla
412x180x60 mm
Cubetilla
112.0659.398
7612986099300
99 €

37



Roll-up
424 x 267 mm
Escurreidor
enrollable
112.0591.081
7612985731454
76 €

44



Tabla de corte
412x180x13mm
Tabla de corte
112.0591.082
7612985731461
99 €

MYTHOS

24

37

44

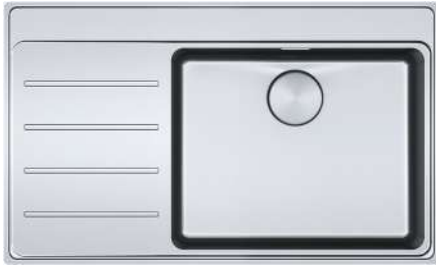

DE POR VIDA GARANTÍA

if DESIGN AWARD 2020

reddot design award winner 2020

Mueble: 60 cm
Instalación: A ras/Encastre
Material: Acero inoxidable
Totales: 860 x 520; R10 mm
Cubeta: 500 x 400 x 180; R25mm
Encastre: 846 x 506; R10-20 mm

MYTHOS MYX 211-86 TL
Modelo escurridor izquierda
127.0638.283
7612985958165
969 €

MYTHOS MYX 211-86 TL
Modelo escurridor derecha
127.0638.285
7612985958172
969 €

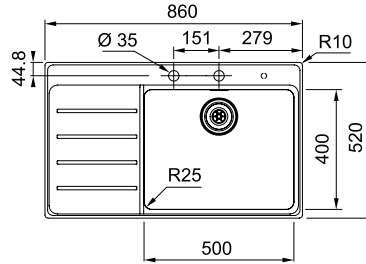

MYTHOS

24

37

44



DE POR VIDA GARANTÍA

if DESIGN AWARD 2020

reddot design award winner 2020

Mueble: 60 cm
Instalación: A ras/Encastre
Material: Acero inoxidable
Totales: 860 x 520 mm R10
Cubetas: 340 x 400 x 200; R25 mm
160 x 400 x 150; R25 mm
Encastre: 846 x 506; R10-20 mm

MYTHOS MYX 251-86 TL
Modelo escurridor izquierda
127.0638.286
7612985958189
1.096 €

MYTHOS MYX 251-86 TL
Modelo escurridor derecha
127.0638.287
7612985958196
1.096 €

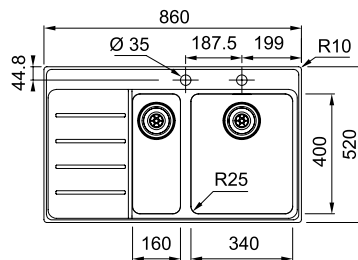

Maris



Accesorios opcionales



11
All-In
Guía-cubetilla-tabla
corde
 Accesorio All -In
 112.0655.481
 7612986084603
138 €



12
All-In
Guía-bolx2-tabla de
corde
 Accesorios All -In
 112.0655.482
 7612986084610
161 €

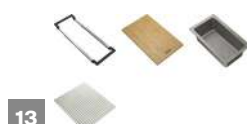

13
All-In
Guía-cubetilla-
tabla corde-escu
Accesorios All -In
 112.0655.483
 7612986084627
195 €



14
All-In
Guía-bolx2-tabla corde-
escurridor
 Accesorios All -In
 112.0655.488
 7612986084641
207 €

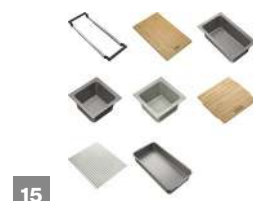

15
All-In
Full set con caja
almacenaje
 Accesorios All -In
 112.0655.489
 7612986084658
253 €



27
Cubetilla inox MTX
172x412
 112.0057.850
 7612980040674
48 €



28
Cubetilla MRX
317x177x60,8
 112.0041.519
 7612142236754
48 €



35
Roll-up 468 x 440 mm
Escurridor enrollable
 112.0080.355
 7612980499175
91 €



50
Sifón salvaespacio
1 Vía salida 40mm
 112.0048.206
 7612319502767
19 €



51
Sifón salvaespacio
2 Vías salida 40mm
 112.0624.484
 7612985884273
27 €

MARIS

- 11
- 12
- 13
- 14
- 15
- 50



Mueble: **60 cm**
 Instalación: **A ras/Encastre**
 Material: **Acero inoxidable**
 Totales: **1.000 x 510; R10 mm**
 Cubeta: **435 x 435 x 180; R70 mm**
 Encastre: **987 x 497 mm**

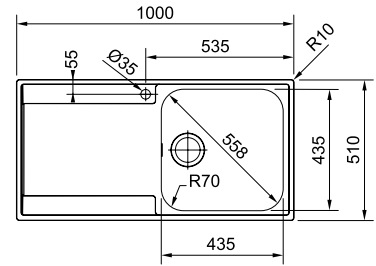

MARIS MRX 211
127.0282.420
 7612981039561
623 €



Cubetas

Fregaderos

Grifos

Campanas

Electrodomésticos

Gestión de residuos

Accesorios

MARIS

- 11
- 12
- 13
- 14
- 15
- 28
- 51



Mueble: **60 cm**
 Instalación: **A ras/Encastre**
 Material: **Acero inoxidable**
 Totales: **1.000 x 510; R10 mm**
 Cubetas: **350 x 435 x 175; R70 mm**
160 x 300 x 120 mm
 Encastre: **987 x 497 mm**

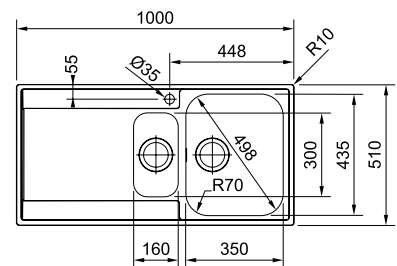

MARIS MRX 251
127.0282.415
 7612981039554
669 €



MARIS

27

35

DE POR VIDA
 GARANTÍA

Mueble: **60 cm**
 Instalación: **A ras/Encastre**
 Material: **Acero inoxidable**
 Totales: **1.004 x 514 mm**
 Cubeta: **480 x 400 x 190; R36 mm**
 Encastre: **995 x 506 mm R20**

ATON ANX 211-100
 Modelo escurridor izquierda
127.0250.577
 7612980757824
426 €

ATON ANX 211-100
 Modelo escurridor derecha
127.0250.555
 7612980757626
426 €

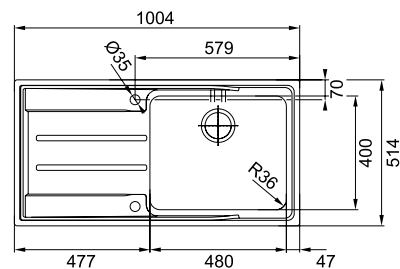

MARIS

27

35

DE POR VIDA
 GARANTÍA

Mueble: **60 cm**
 Instalación: **A ras/Encastre**
 Material: **Acero inoxidable**
 Totales: **1.004 x 514 mm**
 Cubetas: **340 x 400 x 190; R36 mm**
165 x 306 x 130 mm
 Encastre: **995 x 506; R20 mm**

ATON ANX 251
 Modelo escurridor izquierda
127.0250.616
 7612980758012
473 €

ATON ANX 251
 Modelo escurridor derecha
127.0250.615
 7612980758005
473 €

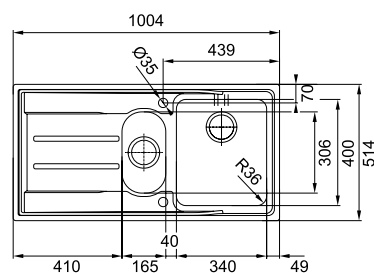

MARIS



Mueble: **80 o 90 cm si está pegado a la pared**
 Instalación: **A ras/Encastre**
 Material: **Acero inoxidable**
 Totales: **864 x 514 mm**
 Cubeta: **340 x 400 x 190; R36 mm**
 Encastre: **844 x 494 mm**

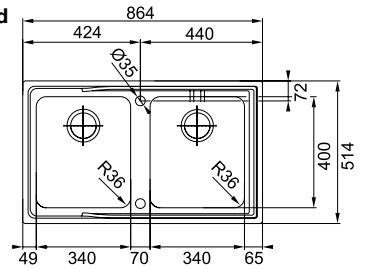

DE POR VIDA
GARANTÍA

ATON ANX 220
 127.0204.598
 7612980689460
507 €



MARIS

- 11
- 12
- 13
- 14
- 15
- 25



Mueble: **80 cm**
 Instalación: **A ras/Encastre**
 Material: **Acero inoxidable**
 Totales: **625 x 510; R10 mm**
 Cubeta: **435 x 435 x 100; R70 mm**
 Encastre: **612 x 497; R0-10 mm**

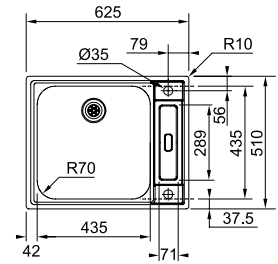

DE POR VIDA
GARANTÍA

ARGOS AGX 210C IX
 127.0319.663
 7612981230166
611 €



MARIS

- 11
- 12
- 13
- 14
- 15
- 51



Mueble: **Angular 90 x 90 cm**
 Instalación: **Encastre**
 Material: **Acero inoxidable**
 Totales: **830 x 830 x 500 mm**
 Cubetas: **340 x 400 x 180 mm**
 Encastre: **Ver plano de corte incluido en el fregadero**

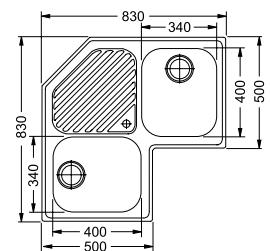

Plano de encastre

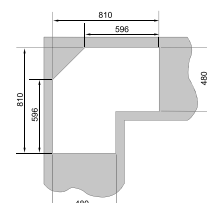

DE POR VIDA
GARANTÍA

PROGRESO ANGULAR
 PNX-621-E
 101.0155.386
 7612318076016
623 €



Cubetas

Fregaderos

Grifos

Campanas

Electrodomésticos

Gestión de residuos

Accesorios

Smart



Accesorios opcionales



11
All-In
Guía-cubetilla-tabla
corte
 Accesorios All -In
 112.0655.481
 7612986084603
138 €



12
All-In
Guía-bolx2-tabla de
corte
 Accesorios All -In
 112.0655.482
 7612986084610
161 €

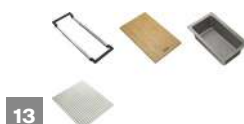

13
All-In
Guía-cubetilla-
tabla corte-escu
 Accesorios All -In
 112.0655.483
 7612986084627
195 €

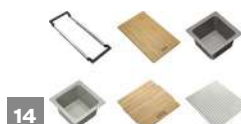

14
All-In
Guía-bolx2-tabla corte-
escurridor
 Accesorios All -In
 112.0655.488
 7612986084641
207 €



15
All-In
Full set con caja
almacenaje
 Accesorios All -In
 112.0655.489
 7612986084658
253 €



reddot winner 2022



27
Cubetilla inox MTX
412 x 172 x 55 mm
 112.0057.850
 7612980040674
48 €



28
Cubetilla MRX
317 x 177 x 60,8 mm
 112.0041.519
 7612142236754
48 €



47
Tabla de corte Bamboo
280x532
 Tabla de corte
 112.0595.334
 7612985746939
57 €



50
Sifón salvaespacio
1 vía salida 40mm
 112.0048.206
 7612319502767
19 €



51
Sifón salvaespacio
2 vías salida 40mm
 112.0624.484
 7612985884273
27 €

SMART

- 11 27
- 12 28
- 13
- 14
- 15



Mueble: **60 cm**
 Instalación: **Encastre**
 Material: **Acero inoxidable**
 Totales: **1.000 x 500; R10 mm**
 Cubetas: **340 x 400 x 180; R70 mm**
160 x 300 x 120 mm
 Encastre: **980 x 480; R10 mm**

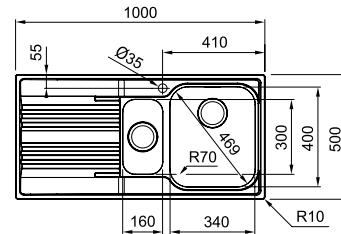

DE POR VIDA
 GARANTÍA

SMART SRX 651
 Modelo escurridor izquierda
101.0356.888
 7612981472399
334 €

SMART SRX 651
 Modelo escurridor derecha
101.0356.887
 7612981472382
334 €

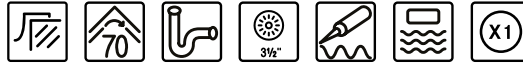

Cubetas

Fregaderos

SMART

- 11
- 12
- 13
- 14
- 15
- 28



Mueble: **80 cm**
 Instalación: **Encastre**
 Material: **Acero inoxidable**
 Totales: **860 x 500; R10 mm**
 Cubetas: **340 x 400 x 180; R70 mm**
 Encastre: **840 x 480; R10 mm**

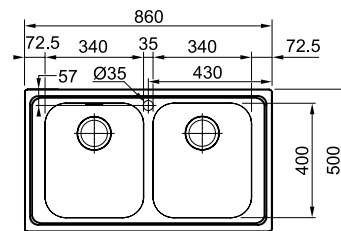

DE POR VIDA
 GARANTÍA

SMART SRX 620
101.0501.823
 7612985132626
253 €



Grifos

SMART

- 11
- 12
- 13
- 14
- 15
- 28



Mueble: **60 cm**
 Instalación: **Encastre**
 Material: **Acero inoxidable**
 Totales: **860 x 500; R10 mm**
 Cubetas: **450 x 400 x 190; R70 mm**
 Encastre: **840 x 480; R10 mm**

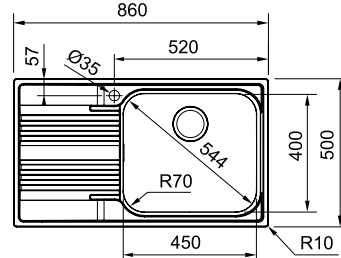

DE POR VIDA
 GARANTÍA

SMART SRX 611LB
 Modelo escurridor izquierda
101.0501.822
 7612985132619
230 €

SMART SRX 611LB
 Modelo escurridor derecha
101.0501.821
 7612985132602
230 €



Campanas

Electrodomésticos

SMART

- 11
- 12
- 13
- 14
- 15
- 28



Mueble: **45 cm**
 Instalación: **Encastre**
 Material: **Acero inoxidable**
 Totales: **860 x 500; R10 mm**
 Cubeta: **340 x 400 x 180; R70 mm**
 Encastre: **840 x 480; R10 mm**

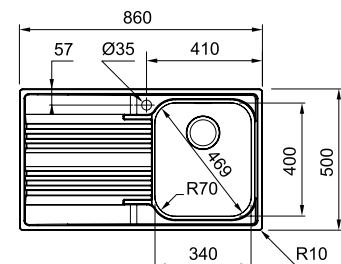

DE POR VIDA
 GARANTÍA

SMART SRX 611-86
 Modelo escurridor izquierda
101.0501.770
 7612985131193
207 €

SMART SRX 611-86
 Modelo escurridor derecha
101.0501.768
 7612985131179
207 €

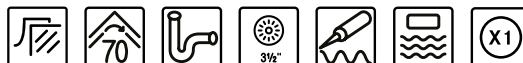

Gestión de residuos

Accesorios

SMART

50



Mueble: **60 cm**
 Instalación: **Encastre**
 Material: **Acero inoxidable**
 Totales: **1.000 x 500; R8 mm**
 Cubeta: **450 x 420 x 160; R80 mm**
 Encastre: **980 x 480 mm**

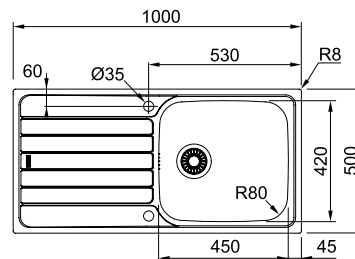

DE POR
VIDA
GARANTÍA

SPARK SKX 611 L
101.0653.322
 7612986055900
230 €



SMART

51

47



Mueble: **80 cm**
 Instalación: **Encastre**
 Material: **Acero inoxidable**
 Totales: **1.160 x 500; R8 mm**
 Cubetas: **345 x 395 x 160 mm R90**
 Encastre: **1.140 x 480 mm R10**

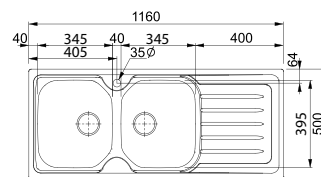

SMART

50

47



ONDA LINE OLX-621
 Modelo escurridor izquierda
101.0280.121
 7612318177683
265 €

ONDA LINE OLX-621
 Modelo escurridor derecha
101.0280.120
 7612318177676
265 €



SMART

50

47

ONDA LINE OLX 611
 Modelo escurridor izquierda
101.0155.455
 7612318208875
184 €

ONDA LINE OLX 611
 Modelo escurridor derecha
101.0155.454
 7612318210274
184 €



SMART

51

47



Mueble: **80 cm**
 Instalación: **Encastre**
 Material: **Acero inoxidable**
 Totales: **790 x 500; R7 mm**
 Cubetas: **345 x 395 x 160; R90 mm**
 Encastre: **770 x 480 mm**

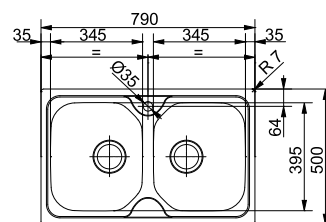

DE POR
VIDA
GARANTÍA

ONDA LINE OLX 620-79
101.0280.118
 7612981031855
207 €

ONDA LINE OLX 620-79 5/UNI
101.0280.119
 7612981031862
195 €



SMART

50



Mueble: **45 cm**
 Instalación: **Encastre**
 Material: **Acero inoxidable**
 Totales: **780 x 435; R5 mm**
 Cubeta: **340 x 370 x 140; R100 mm**
 Encastre: **760 x 415 mm**

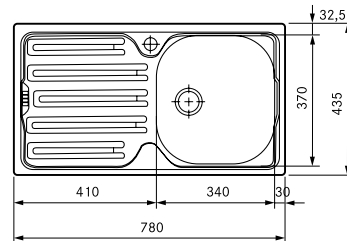

DE POR VIDA
 GARANTÍA

COLIBRÍ CIN 611
 Modelo escurridor izquierda
101.0155.327
 7612318178703
149 €

COLIBRÍ CIN 611
 Modelo escurridor derecha
101.0155.323
 7612318178697
149 €

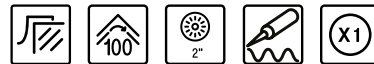

SMART

50



Mueble: **45 cm**
 Instalación: **Encastre**
 Material: **Acero inoxidable**
 Totales: **780 x 435; R5 mm**
 Cubeta: **340 x 370 x 140; R100 mm**
 Encastre: **760 x 415 mm**

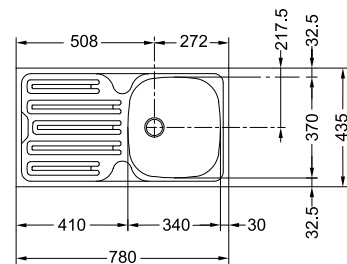

DE POR VIDA
 GARANTÍA

CIN-611 REV. 5/unidades
 Modelo reversible
101.0155.325
 7612318201395
145 €



SMART

51



Mueble: **80 cm**
 Instalación: **Encastre**
 Material: **Acero inoxidable**
 Totales: **780 x 435; R5 mm**
 Cubetas: **340 x 370 x 145; R100 mm**
 Encastre: **760 x 415 mm**

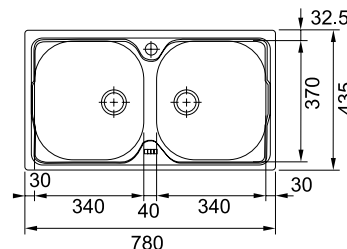

DE POR VIDA
 GARANTÍA

COLIBRÍ CIN 620
101.0155.328
 7612318178727
195 €

COLIBRÍ CIN 620 5/UNI
101.0152.656
 7612318178673
191 €

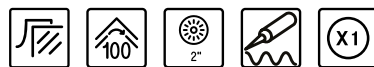

Cubetas

Fregaderos

Grifos

Campanas

Electrodomésticos

Gestión de residuos

Accesorios

Fregaderos Color

Mueble de
45 cm

Mueble de
60 cm

MYTHOS

MARIS

SMART



FRESNO FSG 611-88
Fragranite
p. 113



MYTHOS MTG 611
Fragranite
p. 113



MYTHOS MTG 651-100
Fragranite
p. 113



MARIS MRG 611-78
Fragranite
p. 115



CENTRO CNG-611-62
Fragranite
p. 116



MARIS MRG 651
Fragranite
p. 115



MARIS MRG 611 L
Fragranite
p. 115



CENTRO CNG-611-100
Fragranite
p. 116



CENTRO CNG-611-78XL
Fragranite
p. 116



URBAN UBG 611-100
Fragranite
p. 117



URBAN UBG 611-78 L
Fragranite
p. 117



SIRIUS S2D 651
Tectonite
p. 120



SIRIUS S2D 611-78 XL
Tectonite
p. 120



SIRIUS S2D 611 L
Tectonite
p. 120



TITAN TTD 651
Tectonite
p. 121



TITAN TTD 611-97
Tectonite
p. 121

Mueble de
80 cm

Mueble de
90 cm



FRESNO FSG 211-86*
Fragranite
p. 113



TITAN TTD 621
Tectonite
p. 121

Cubetas

Fregaderos

Girfos

Campanas

Electrodomésticos

Gestión de residuos

Accesorios



FRA
GRA
NITE

Fregaderos Fra granite

112

114

Mythos

Maris





Cubetas

Fregaderos

Grifos

Campanas

Electrodomesticos

Gestión de residuos

Accesorios

Mythos



Accesorios opcionales

22



Cubetilla inox
156x417x54mm R12.5
 Cubetilla
 112.0066.060
 7612980052851
122 €

36



Roll-up Fresno 220 x 400mm
 Ecurridor enrollable
 112.0520.938
 7612985443463
91 €

38



Roll-up 468 x 420 mm
 Ecurridor enrollable
 112.0030.882
 7612142241574
80 €

MYTHOS

22

36



Mueble: 90 cm
 Instalación: A ras / Bajo encimera
 Material: **Fragranite**
 Totales: 860 x 460; R10 mm
 Cubeta: 496 x 425 x 195; R10 mm
 Bajo encimera: 826 x 424; R4,5 mm

Stone grey
 135.0638.090
 7612985957601
 784 €

Onyx
 135.0531.317
 7612985481915
 784 €

Blanco Polar
 135.0638.087
 7612985957472
 784 €

Negro mate
 135.0629.150
 7612985915144
 784 €

5 AÑOS GARANTÍA

FRESNO FSG 211-86*

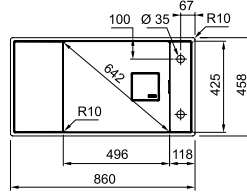

MYTHOS

22

36



Mueble: 60 cm
 Instalación: **Encastre**
 Material: **Fragranite**
 Totales: 877 x 495 mm R28
 Cubeta: 496 x 425 x 195; R10 mm
 Encastre: 845 x 463; R20 mm

Onyx
 114.0624.215
 7612985881975
 669 €

Negro mate
 114.0628.955
 7612985914499
 669 €

5 AÑOS GARANTÍA

FRESNO FSG 611-88*

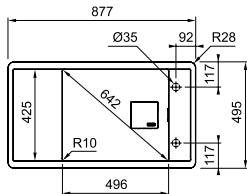

MYTHOS

38



Mueble: 60 cm
 Instalación: **Encastre**
 Material: **Fragranite**
 Totales: 1.000 x 515 mm R8
 Cubeta: 500 x 390 x 200; R29 mm
 Encastre: 980 x 495 mm

Onyx Izquierda
 114.0250.181
 7612980701742
 634 €

Onyx Derecha
 114.0250.183
 7612980701773
 634 €

5 AÑOS GARANTÍA

MYTHOS MTG 611*

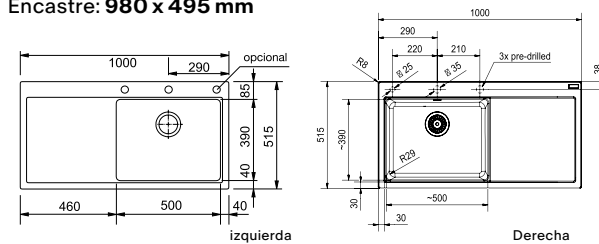

MYTHOS



Mueble: 60 cm
 Instalación: **Encastre**
 Material: **Fragranite**
 Totales: 1.000 x 515; R8 mm
 Cubetas: 360 x 390 x 200; R29 mm
 160 x 390 x 140 mm
 Encastre: 980 x 495; R25 mm

Onyx Izquierda
 114.0250.830
 7612980772322
 657 €

Onyx Derecha
 114.0250.841
 7612980772339
 657 €

5 AÑOS GARANTÍA

MYTHOS MTG 651-100*

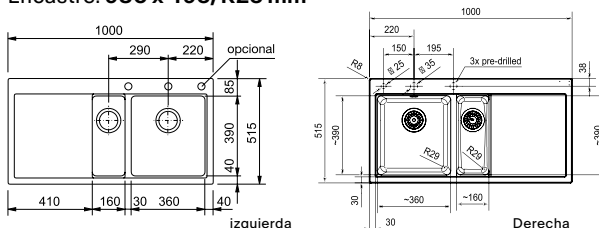

*Bajo demanda

Maris



Accesorios opcionales



11
All-In
Guía-cubetilla-tabla
corte
 Accesorios All -In
112.0655.481
 7612986084603
138 €



12
All-In
Guía-bolx2-tabla de
corte
 Accesorios All -In
112.0655.482
 7612986084610
161 €

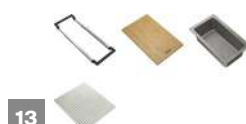

13
All-In
Guía-cubetilla-
Tabla corte-escu
 Accesorios All -In
112.0655.483
 7612986084627
195 €



14
All-In
Guía-bolx2-tabla corte-
escurridor
 Accesorios All -In
112.0655.488
 7612986084641
207 €

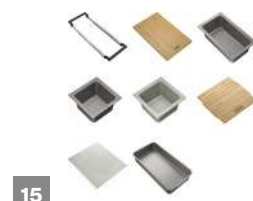

15
All-In
Full set con caja
almacenaje
 Accesorios All -In
112.0655.489
 7612986084658
253 €



17
Cesta-vajilla
Inox 375X295X134
112.0156.214
 7612318074685
45 €



22
Cubetilla inox
156x417x54mm R12.5
112.0066.060
 7612980052851
122 €



29
Escurridor gris
440x181x92mm
 Escurridor
112.0538.950
 7612985514781
23 €



39
Roll-up 366 x 326 mm
 Escurridor enrollable
112.0075.642
 7612980071180
57 €









47
Tabla de corte bambú
280x532
 Tabla de corte
112.0595.334
 7612985746939
57 €

MARIS

- 11 22
- 12 39
- 13
- 14
- 15
- 17



Mueble: 60 cm
 Instalación: **Encastre**
 Material: **Fragranite**
 Totales: 970 x 500; R8 mm
 Cubetas: 350 x 425 x 200; R19 mm
 160 x 302 x 120 mm
 Encastre: 950 x 480; R20 mm

- | | |
|--|---|
|  Onyx
114.0525.511
7612985459464
491 € |  Stone grey
114.0152.114
7612315094693
491 € |
|  Blanco Polar
114.0152.112
7612315094686
491 € |  Oyster
114.0491.759
7612981907853
491 € |
|  Negro mate
114.0628.993
7612985914666
491 € |  Café creme
114.0152.099
7612315094952
491 € |

5
AÑOS
GARANTÍA

MARIS
MRG 651*

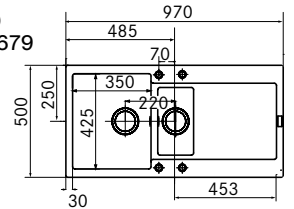







MARIS

- 11 22
- 12 39
- 13
- 14
- 15
- 17



Mueble: 60 cm
 Instalación: **Encastre**
 Material: **Fragranite**
 Totales: 970 x 500; R8 mm
 Cubeta: 450 x 425 x 200; R19 mm
 Encastre: 950 x 480; R20 mm

- | | |
|---|---|
|  Onyx
114.0525.488
7612985459433
480 € |  Stone grey
114.0152.235
7612315094556
480 € |
|  Blanco Polar
114.0152.234
7612315094549
480 € |  Oyster
114.0491.755
7612981907822
480 € |
|  Negro mate
114.0628.967
7612985914628
480 € |  Café creme
114.0152.027
7612315094938
480 € |

5
AÑOS
GARANTÍA

MARIS
MRG 611*

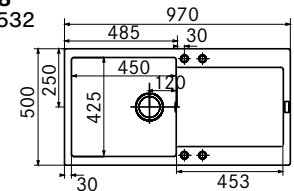







MARIS

- 11 22
- 12 39
- 13
- 14
- 15



Mueble: 45 cm
 Instalación: **Encastre**
 Material: **Fragranite**
 Totales: 780 x 500; R8 mm
 Cubeta: 350 x 425 x 200; R19 mm
 Encastre: 760 x 480; R20 mm

- | | |
|--|---|
|  Onyx
114.0525.487
7612985459426
445 € |  Stone grey
114.0152.039
7612315094624
445 € |
|  Blanco Polar
114.0152.032
7612315094617
445 € |  Oyster
114.0491.752
7612981907785
445 € |
|  Negro mate
114.0628.968
7612985914635
445 € |  Café creme
114.0152.028
7612315094945
445 € |

5
AÑOS
GARANTÍA

MARIS
MRG 611-78*

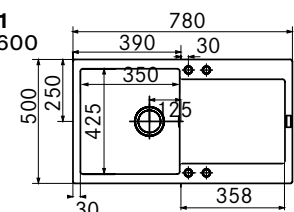

*Bajo demanda

MARIS

11
12
13
14
15
47

Mueble: 60 cm
 Instalación: **Encastre**
 Material: **Fragranite**
 Totales: 1.000 x 500; R15 mm
 Cubeta: 492 x 435 x 200; R20 m
 Encastre: 966 x 466 mm R15

Onyx
 114.0691.314
 7612986279344
 449 €

Blanco Polar
 114.0691.310
 7612986279306
 449 €

Negro mate
 114.0691.315
 7612986279351
 449 €

Platinum
 114.0691.312
 7612986279320
 449 €

Stone grey
 114.0691.313
 7612986279337
 449 €

Oyster
 114.0682.507
 7612986234046
 449 €

Café creme
 114.0691.311
 7612986279313
 449 €

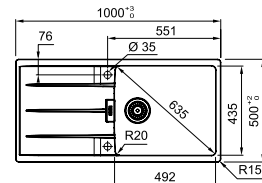

5
 AÑOS
 GARANTÍA

CENTRO
 CNG-611-100



MARIS

11
12
13
14
15
47

Mueble: 60 cm
 Instalación: **Encastre**
 Material: **Fragranite**
 Totales: 780 x 500 mm R15
 Cubeta: 492 x 435 x 200; R20 mm
 Encastre: 746 x 466 mm R15

Onyx
 114.0691.308
 7612986278187
 426 €

Blanco Polar
 114.0691.291
 7612986279115
 426 €

Negro mate
 114.0691.309
 7612986278194
 426 €

Stone grey
 114.0691.307
 7612986278170
 426 €

Café creme
 114.0691.292
 7612986279122
 426 €

Platinum
 114.0691.306
 7612986278163
 426 €

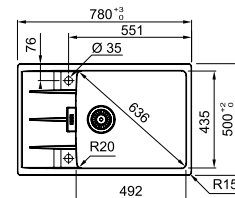

5
 AÑOS
 GARANTÍA

CENTRO
 CNG-611-78XL



MARIS

11
12
13
14
15
47

Mueble: 45 cm
 Instalación: **Encastre**
 Material: **Fragranite**
 Totales: 620 x 500 mm R15m
 Cubeta: 342 x 435 x 200; R20 mm
 Encastre: 586 x 466 mm R15

*sifón no incluido en el FUN 114.0681.430

Onyx
 114.0691.255
 7612986278897
 415 €

Blanco Polar
 114.0691.240
 7612986278859
 415 €

Negro mate
 114.0691.256
 7612986279009
 415 €

Platinum
 114.0691.253
 7612986278873
 415 €

Stone grey
 114.0691.254
 7612986278880
 415 €

Oyster*
 114.0681.430
 7612986231441
 415 €

Café creme
 114.0691.252
 7612986278866
 415 €

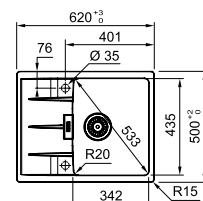

5
 AÑOS
 GARANTÍA

CENTRO
 CNG-611-62



MARIS

- 11
- 12
- 13
- 14
- 15
- 29



Mueble: 60 cm
 Instalación: **Encastre**
 Material: **Fragranite**
 Totales: **1.000 x 500 R15 mm**
 Cubeta: **490 x 425 x 220; R15 mm**
 Encastre: **964 x 464; R15 mm**

- | | |
|---|---|
| <p>Onyx
 114.0682.530
 7612986234176
 438 €</p> <p>Blanco Polar
 114.0682.525
 7612986234121
 438 €</p> <p>Negro mate
 114.0682.527
 7612986234145
 438 €</p> <p>Platinum
 114.0694.104
 7612986297683
 438 €</p> | <p>Stone grey
 114.0682.529
 7612986234169
 438 €</p> <p>Oyster
 114.0682.528
 7612986234152
 438 €</p> <p>Café creme
 114.0694.102
 7612986297669
 438 €</p> |
|---|---|

5
 AÑOS
 GARANTÍA

URBAN
 UBG 611-100

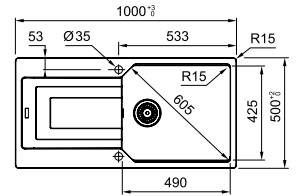

MARIS

- 11
- 12
- 13
- 14
- 15
- 29



Mueble: 60 cm
 Instalación: **Encastre**
 Material: **Fragranite**
 Totales: **780 x 500; R15 mm**
 Cubeta: **490 x 425 x 220; R15 mm**
 Encastre: **744 x 464 ; R15 mm**

- | | |
|---|---|
| <p>Onyx
 114.0682.570
 7612986234565
 392 €</p> <p>Blanco Polar
 114.0682.565
 7612986234527
 392 €</p> <p>Negro mate
 114.0682.566
 7612986234534
 392 €</p> <p>Platinum
 114.0694.051
 7612986300253
 392 €</p> | <p>Stone grey
 114.0682.569
 7612986234558
 392 €</p> <p>Oyster
 114.0639.467
 7612985963459
 392 €</p> <p>Café creme
 114.0693.989
 7612986300239
 392 €</p> |
|---|---|

5
 AÑOS
 GARANTÍA

URBAN
 UBG 611-78 L

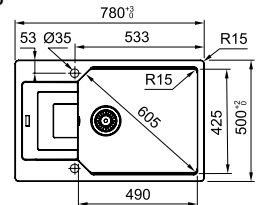

Cubetas

Fregaderos

Girfos

Campanas

Electrodomésticos

Gestión de residuos

Accesorios

Cubetas

Fregaderos

Grifos

Campanas

Electrodomésticos

Gestión de residuos

Accesorios





TEC
TON
ITE

Fregaderos Tectonite

120

121

Sirius

Titan

Cubetas

Fregaderos

Grifos

Campanas

Electrodomésticos

Gestión de residuos

Accesorios

SMART

- 11
- 12
- 13
- 14
- 15



Mueble: **60 cm**
 Instalación: **Encastre**
 Material: **Tectonite**
 Totales: **1.000 x 500 mm R8**
 Cubetas: **350 x 432 x 200; R10 mm**
 Encastre: **984 x 484; R7,5 mm**

Carbone
143.0629.193
 7612985915717
380 €

Blanco polar
143.0634.555
 7612985938860
380 €

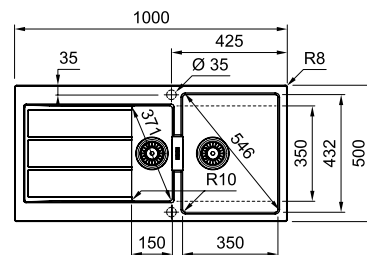

5 AÑOS GARANTÍA

SIRIUS S2D 651



SMART

- 11
- 12
- 13
- 14
- 15



Mueble: **60 cm**
 Instalación: **Encastre**
 Material: **Tectonite**
 Totales: **780 x 500 mm R8**
 Cubeta: **440 x 432 x 200; R10 mm**
 Encastre: **764 x 484; R7,5 mm**

Carbone
143.0617.613
 7612985848695
284 €

Blanco polar
143.0617.615
 7612985848916
284 €

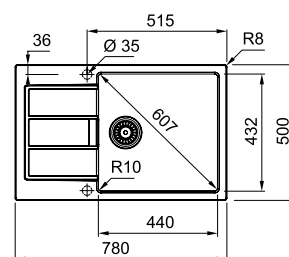

5 AÑOS GARANTÍA

SIRIUS S2D 611-78 XL



SMART

- 11
- 12
- 13
- 14
- 15



Mueble: **60 cm**
 Instalación: **Encastre**
 Material: **Tectonite**
 Totales: **1.000 x 500; R8 mm**
 Cubeta: **450 x 432 x 200; R10 mm**
 Encastre: **984 x 484 mm; R7,5**

Carbone
143.0616.274
 7612985842143
307 €

Blanco polar
143.0616.928
 7612985843942
307 €

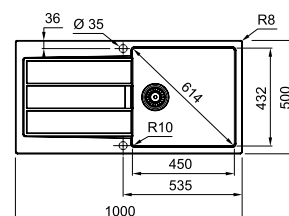

5 AÑOS GARANTÍA

SIRIUS S2D 611 L



SMART

- 11
- 12
- 13
- 14
- 15



Mueble: **80 cm**
 Instalación: **Encastre**
 Material: **Tectonite**
 Totales: **1160 x 500 mm**
 Cubetas: **337 x 420 x 190 mm**
337 x 420 x 190 mm
 Encastre: **1140 x 480**

Beige
114.0278.749
 7612981022709
357 €

Carbone
114.0278.751
 7612981022723
357 €

Platinum
114.0278.750
 7612981022716
357 €

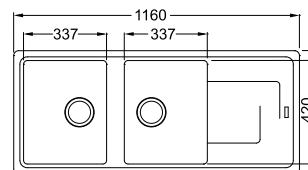

5
 AÑOS
 GARANTÍA

TITAN
TTD 621



Cubetas

Fregaderos

Grifos

SMART

- 11
- 12
- 13
- 14
- 15



Mueble: **60 cm**
 Instalación: **Encastre**
 Material: **Tectonite**
 Totales: **970 x 500 mm**
 Cubetas: **340 x 420 x 190 mm**
150 x 290 x 120
 Encastre: **950 x 480**

Beige
114.0278.725
 7612981022662
345 €

Carbone
114.0278.747
 7612981022686
345 €

Platinum
114.0278.726
 7612981022679
345 €

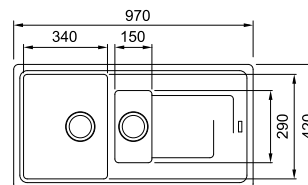

5
 AÑOS
 GARANTÍA

TITAN
TTD 651

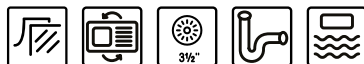

Campanas

Electrodomesticos

SMART

- 11
- 12
- 13
- 14
- 15



Mueble: **60 cm**
 Instalación: **Encastre**
 Material: **Tectonite**
 Totales: **970 x 500 mm**
 Cubeta: **450 x 420 x 190 mm**
 Encastre: **950 x 480**

Beige
114.0278.720
 7612981022624
288 €

Carbone
114.0278.723
 7612981022648
288 €

Platinum
114.0278.722
 7612981022631
288 €

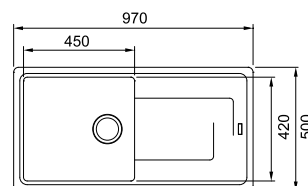

5
 AÑOS
 GARANTÍA

TITAN
TTD 611-97

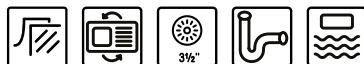

Gestión de residuos

Accesorios

Cubetas

Fregaderos

Grifos

Campanas

Electrodomésticos

Gestión de residuos

Accesorios





Picto gramas

**FRA
GRA
NITE**

Composición de granito natural, garantiza durabilidad y robustez

**TEC
TON
ITE**

Material altamente resistente de última tecnología, fabricado a partir de SMC (Sheet Moulding Compound) con revestimiento de PIMC

**DE POR
VIDA
GARANTÍA**

Resistencia a la corrosión y soldadura (excluyendo la válvula)



Sanitized®: Tratamiento antibacteriano que reduce un 99% la proliferación de microbios y bacterias.



A ras: El orificio y rebaje debe realizarse basándose en las medidas/espesor del fregadero físico a enrasar. Este proceso debe ser ejecutado siempre por un profesional especializado.



Encastre: El fregadero reposa sobre la encimera



Instalación bajo encimera



Reversible



Radio de la cubeta



Sifón



Válvula automática con mando pulsable



Válvula automática con mando giratorio



Válvula manual 3 1/2"



Fijación Fast Fix



Conjunto de fijación



Fregaderos con 2 orificios pre perforados Ø 35 mm



Conjunto rebosadero



Nº de agujeros



Grifos

128	Agua Filtrada
136	Semiprofesionales
144	Tendencia diseño
180	Dispensadores de jabón

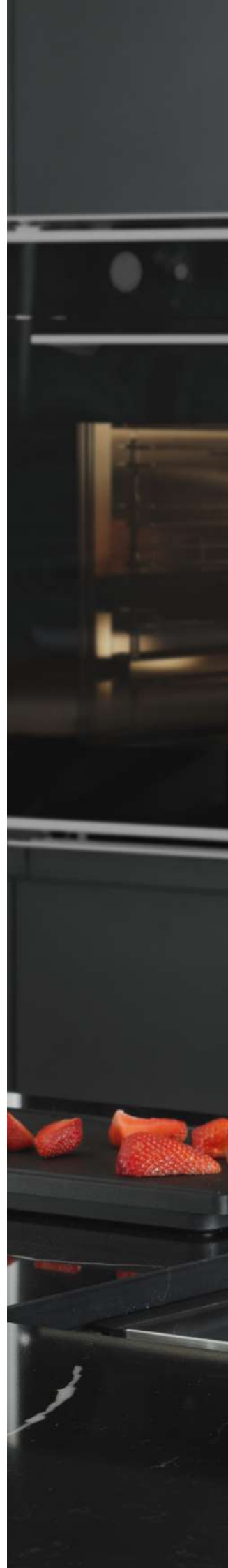



Cubetas

Fregaderos

Grifos

Campanas

Electrodomésticos

Gestión de residuos

Accesorios

Grifos

Cubetas

Fregaderos

Grifos

Campanas

Electrodomésticos

Gestión de residuos

Accesorios

Agua Filtrada

Semiprofesional

Acero Inoxidable

MYTHOS



VITAL SEMIPRO
p. 133



VITAL J
p. 133



VITAL AGUA FILTRADA
p. 133



ICON SEMI PRO
p. 138



PESCARA 360 y L SEMI-PRO
p. 140



CENTINOX PLUS
p. 141



MYTHOS
p. 147



ATLAS NEO SENSOR PULL OUT
p. 150



EOS PULL OUT
p. 153



EOS NEO SWIVEL
p. 155



TANGO NEO PULL OUT
p. 162

MARIS



ATLAS CLEAR
p. 135



EOS CLEAR
p. 135



NEPTUNE CLEAR
p. 135



ACTIVE SEMI PRO
p. 139



FOX SEMI-PRO
p. 142



LINA SEMIPRO
p. 143



ATLAS NEO PULL OUT / SPRAY
p. 151



ATLAS NEO
p. 152



EOS NEO / PULL OUT
p. 154

SMART

Metálico



ICON PULL OUT
p. 146



ACTIVE TWIST / PULL OUT
p. 163



ACTIVE PLUS / PULL OUT / PULL OUT SPRAY / SWIVEL
p. 164, 165, 166



ACTIVE NEO / PULL OUT
p. 167



NEPTUNE EVO / PULL OUT
p. 168



AMBIENT / PULL OUT
p. 175



SIRIUS Pull out
p. 169



ACTIVE NEO / PULL OUT
p. 171



NEPTUNE STYLE WINDOW
p. 172



ATLAS NEO WINDOW
p. 173



URBAN PULL OUT
p. 170



URBAN U SPOUT
p. 174



SUPER TRAMS y TRAMS MIX
p. 176



LINA PULL OUT
p. 177



LINA XL SWIVEL
p. 178



LINA L SWIVEL
p. 179

Solución Ventana

Cubetas

Fregaderos

Girifos

Campanas

Electrodomésticos

Gestión de residuos

Accesorios



Agua Filtrada

130

Vital

134

ClearWater



Cubetas

Fregaderos

Grifos

Campanas

Electrodomésticos

Gestión de residuos

Accesorios

Grifo de Agua Filtrada Vital

Filtro pequeño, grandes beneficios



Para más información sobre el
Grifo Vital, escanea el
siguiente código



¿Por qué es tan especial el grifo Vital?

Por su pequeño y poderoso filtro.

Un diseño único que no sólo es el más pequeño del mundo, sino también el primero en combinar carbón activo con una membrana de alta tecnología. Capaz de filtrar y purificar el agua. Adaptándose a tus necesidades de uso y estilo de vida, el filtro está disponible en dos opciones según el flujo de caudal de agua de tu hogar: **filtro de alta presión** y **filtro de alto rendimiento**.

- Disfruta de agua pura y de gran sabor directamente del grifo
- Elimina las impurezas conservando los minerales vitales
- La luz LED indica cuándo hay que cambiar el filtro o la batería
- El filtro se sustituye de forma rápida y sencilla
- Su diseño no requiere ninguna instalación extra bajo el mueble

Ahorra dinero y reduce los residuos plásticos

El grifo Vital ayuda a reducir el impacto medioambiental y ayuda a disminuir los residuos de botellas de plástico en un 99%*, con un ahorro familiar de hasta 400 euros al año**

Parámetros de los valores del filtro

Caudal: 3,5L / min a 3 bar

Rango de temperatura: 1 - 38°C

Rango de presión: 1,0 - 6,8 bar (14,5 - 100 psi)

Capacidad: Hasta 500L, dependiendo de la calidad y presión del agua

*Base de cálculo: peso del filtro Vital = 33,5 g, peso medio de una botella PET de 1 litro = 35,0 g, 1 filtro Vital sustituye a 500 botellas PET, luego 33,5g dividido por 500 x 35, 0 g = 0,2%

**Base de cálculo: una familia promedio de 4 personas consume unos 3.000 litros de agua al año a un precio medio de 0,20 euros por litro de agua mineral; esto supone un coste de 600 euros al año, frente a los 200 euros de seis cápsulas de filtro Vital (periodo de uso recomendado: 1 año).



Vital



Accesorios



FILTRO VITAL ALTO RENDIMIENTO 500L

Individual
112.0607.497
 7612985792257
33 €

Pack 3 Filtros
112.0607.498
 7612985792264
94 €



FILTRO VITAL ALTA PRESION 500L

Individual
112.0606.784
 7612985787826
35 €

Pack 3 Filtros
112.0606.785
 7612985787833
99 €

Adquiera los recambios del
 filtro en www.franke.com/es
 o a través de este QR



MYTHOS

3
AÑOS
GARANTÍA



Material: **Metálico**
Recubrimiento especial: **PVD**
Versión Spray: **Chorro - Ducha**
Manguera extensible: **Metálico**
Ahorro de agua: **Sí**
Rotación cabezal: **360°**
Apertura mando: **0 / 90**
Caudal: **8L/Min (3 bar) Caudal chorro normal / 3.5L/min (3 bar) caudal agua filtrada**
Diámetro orificio: **35 mm**
Incluye 2 filtros vital en dotación
112.0607.497 y 112.0606.784

VITAL SEMIPRO AGUA FILTRADA



 **VITAL SEMIPRO AGUA FILT V2 Negro Mate**
120.0621.313
7612985866910
1.142 €

 **VITAL SEMIPRO AGUA FILT Cromo / Gun metal**
120.0621.230
7612985865586
1.050 €

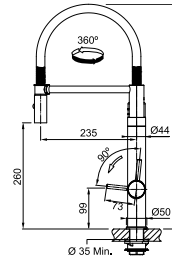

MYTHOS

3
AÑOS
GARANTÍA



Material: **Metálico**
Recubrimiento especial: **PVD**
Caño: **Giratorio**
Ahorro de agua: **Sí**
Rotación cabezal: **360°**
Apertura mando: **0 / 90**
Caudal: **10 L/Min (3 bar) Caudal chorro normal / 3.5L/min (3 bar) caudal agua filtrada**
Diámetro orificio: **35 mm**
Incluye 2 filtros vital en dotación
112.0607.497 y 112.0606.784

VITAL J AGUA FILTRADA



 **VITAL J AGUA FILT V2 Negro Mate**
120.0621.312
7612985866903
819 €

 **VITAL J AGUA FILTRADA Cromo / Gun metal**
120.0621.229
7612985865579
692 €

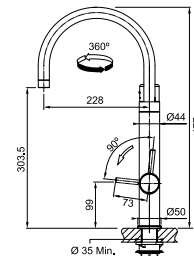

MYTHOS

3
AÑOS
GARANTÍA



Material: **Metálico**
Recubrimiento especial: **PVD**
Caño: **Giratorio**
Ahorro de agua: **Sí**
Rotación cabezal: **360°**
Caudal: **3.5L/min (3 bar) caudal agua filtrada**
Diámetro orificio: **35 mm**

VITAL AGUA FILTRADA



 **VITAL AGUA FILTRADA Cromo / Gun metal**
120.0621.228
7612985865562
496 €

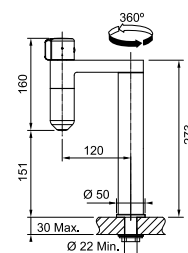

Cubetas

Fregaderos

Grifos

Campanas

Electrodomésticos

Gestión de residuos

Accesorios

Clear Water



**FRANKE
CLEAR WATER**

Capacidad filtrante: **1.500/1.700 L**
 Duración: **Hasta 1 año de agua filtrada**
 Inhibición: **De cloro, de partículas superiores a 5 µm, de componentes orgánicos volátiles y de metales pesados (plomo, cobre, zinc, níquel, etc.)**
 Incluye: **Temporizador para el cambio de filtros, ajustable según consumo a: 90, 180, 270 o 360 días (con aviso sonoro)**
 Compacto: **Ocupa poco espacio**
 Incluye: **1 filtro 133.0284.026**

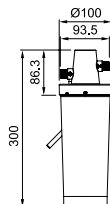

**KIT AGUA FILTRADA
 FRANKE CLEAR WATER
 133.0284.025
 7612981049300
 306 €**

**FILTER
 FRANKE CLEAR WATER
 133.0284.026
 7612981049416
 190 €**

Adquiera los recambios del filtro en **www.franke.com/es** o a través de este QR



MARIS



Material: **Acero Inox 304**
 Caño: **Giratorio**
 Ahorro de agua: **Sí**
 Rotación cabezal: **360°**
 Apertura mando: **45 / 45**
 Caudal: **9L/Min (3bar)**
 Diámetro orificio: **35 mm**
Válido para sistema de agua filtrada/osmosis

ATLAS CLEAR INOX
Acero Inox
120.0179.978
 7612980534739
473 €

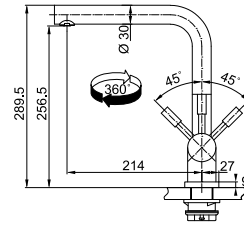

Grifo de agua filtrada
ATLAS CLEAR

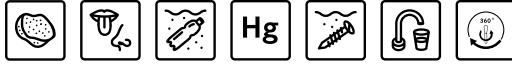

MARIS



Material: **Acero Inox 304**
 Caño: **Giratorio**
 Ahorro de agua: **Sí**
 Rotación cabezal: **360°**
 Apertura mando: **45 / 45**
 Diámetro orificio: **35 mm**
Válido para sistema de agua filtrada/osmosis

EOS CLEAR INOX
Acero Inox
120.0179.979
 7612980534746
449 €

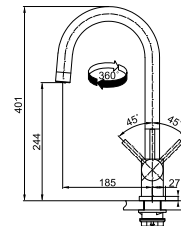

Grifo de agua filtrada
EOS CLEAR

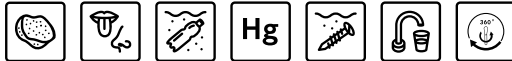

MARIS



Material: **Metálico**
 Caño: **Giratorio**
 Ahorro de agua: **Sí**
 Rotación cabezal: **360°**
 Apertura mando: **0 / 90**
 Diámetro orificio: **35 mm**
Válido para sistema de agua filtrada/osmosis

NEPTUNE CLEAR WATER ONYX / CRO
Onyx
115.0370.694
 7612981585754
426 €

NEPTUNE CLEAR WATER CROMADO
Cromado
115.0370.689
 7612981585730
403 €

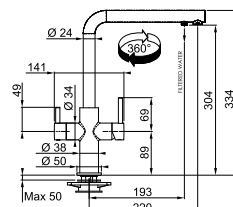

Grifo de agua filtrada
NEPTUNE CLEAR

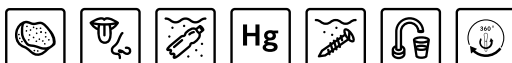

Cubetas

Fregaderos

Grifos

Campanas

Electrodomésticos

Gestión de residuos

Accesorios

Cubetas

Fregaderos

Grifos

Campanas

Electrodomésticos

Gestión de residuos

Accesorios





Cubetas

Fregaderos

Grifos

Campanas

Electrodomésticos

Gestión de residuos

Accesorios

Semipro fesionales

138	Icon
139	Active
140	Pescara
141	Centinox Plus
142	Fox
143	Lina

Icon



MYTHOS



3
AÑOS
GARANTÍA

NEW

Grifo semiprofesional
ICON SEMI PRO



ICON SEMI PRO HP MB
Negro Mate
115.0690.598
7612986276725
799 €

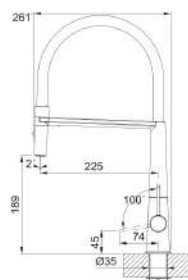

Material: **Metálico**
Recubrimiento especial: **PVD**
Caño: **Retractable con spray**
Rotación cabezal: **360°**
Apertura mando: **0 / 90**
Caudal: **7.7 L/min (3 bar) Caudal chorro normal, 6.8 L/Min (3 bar) Spray**
Diámetro orificio: **35 mm**



reddot winner 2023



MARIS



3
AÑOS
GARANTÍA

NEW



ACTIVE SEMI PRO 2 JETS CHR
Cromado
115.0653.407
7612986056624
549 €



ACTIVE SEMI PRO 2 JETS MB
Negro Mate
115.0653.409
7612986056648
599 €

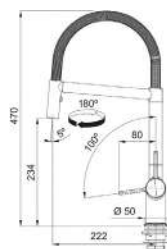

Material: **Metálico**
Recubrimiento especial:
Powder painting
Caño: **Retractable con spray**
Ahorro de agua: **Cartucho ECO**
Rotación cabezal: **180°**
Apertura mando: **0 / 100**
Caudal: **7,5 L/Min (3 bar)**
Diámetro orificio: **35 mm**

Grifo semiprofesional
ACTIVE SEMI PRO
2 JETS



Pescara

Cubetas

Fregaderos

Grifos

Campanas

Electrodomésticos

Gestión de residuos

Accesorios



MYTHOS



3
AÑOS
GARANTÍA



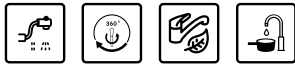

Grifo semiprofesional
PESCARA 360
SEMI-PRO

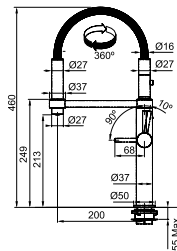

Material: **Metálico**
Caño: **Retractable con spray**
Versión Spray: **Chorro - Ducha**
Manguera extensible: **Negro mate**
Ahorro de agua: **Cartucho Eco**
Rotación cabezal: **360°**
Apertura mando: **10 / 90**
Caudal: **9L/Min (3bar)**
Diámetro orificio: **35 mm**



- 
PESCARA 360 SEMI-PRO NEGRO MAT Negro Mate
115.0545.136
 7612985537025
692 €
- 
PESCARA 360 SEMI-PRO CROMADO Cromado
115.0393.976
 7612981695231
623 €



reddot design award
winner

MYTHOS



3
AÑOS
GARANTÍA





Grifo semiprofesional
PESCARA L
SEMI-PRO

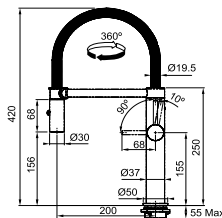

Material: **Versión acero Inox 304 o metálico para el cromado**
Caño: **Retractable con spray**
Versión Spray: **Chorro - Ducha**
Manguera extensible: **Negro mate**
Ahorro de agua: **Cartucho Eco**
Rotación cabezal: **360°**
Apertura mando: **10 / 90**
Caudal: **9L/Min (3bar)**
Diámetro orificio: **35 mm**



- 
PESCARA L SEMI-PRO INOX Acero Inox
115.0472.960
 7612981832001
507 €
- 
PESCARA L SEMI-PRO CROMADO Cromado
115.0393.975
 7612981695224
461 €



reddot design award
winner

Centinox Plus



MYTHOS



3
AÑOS
GARANTÍA

Grifo semiprofesional
CENTINOX PLUS



CENTINOX PLUS SEMI-PRO
Acero Inox
115.0547.855
7612985543484
549 €

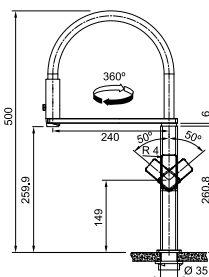

Material: **Acero Inox 304**
Caño: **Retractable con spray**
Versión Spray: **Chorro - Ducha**
Manguera extensible: **Negro mate**
Ahorro de agua: **Sí**
Rotación cabeza: **360°**
Apertura mando: **50 / 50**
Caudal: **8.5/Min 3bar**
Diámetro orificio: **35 mm**

Cubetas

Fregaderos

Grifos

Campanas

Electrodomésticos

Gestión de residuos

Accesorios

Fox

Cubetas

Fregaderos

Grifos

Campanas

Electrodomésticos

Gestión de residuos

Accesorios



MARIS



FOX SEMI-PRO
Cromado
115.0486.993
7612981888909
265 €

3
AÑOS
GARANTÍA



Grifo semiprofesional
FOX SEMI-PRO

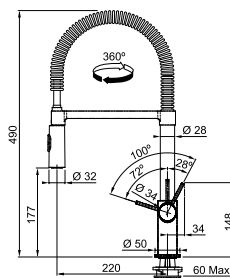

Material: **Metálico**
Caño: **Retractable con spray**
Versión spray: **Chorro-Ducha**
Longitud manguera extensible:
1.500 mm
Ahorro de agua: **Cartucho ECO**
Rotación cabezal: **360°**
Apertura mando: **72 / 28**
Caudal: **10 L/Min (3 bar)**
Diámetro orificio: **35 mm**



Cubetas

Fregaderos

Grifos

Campanas

Electrodomésticos

Gestión de residuos

Accesorios

MARIS



Grifo semiprofesional
LINA SEMIPRO





LINA SEMIPRO CROMO/NEGRO
Cromado / Negro
115.0626.085
 7612985901819
299 €

LINA SEMIPRO CROMO/GRIS
Cromado / Gris
115.0626.087
 7612985901826
299 €

LINA SEMIPRO CROMO/BLANCO
Cromado / Blanco
115.0626.088
 7612985901840
299 €

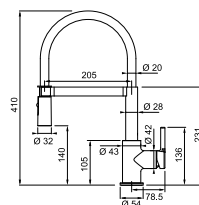
Material: Metálico
Caño: Retractil con spray
Versión Spray: Chorro - Ducha
Manguera extensible: Nylon blanco / gris / negro
Rotación cabezal: 360°
Apertura mando: 0 / 90
Caudal: 9L/Min (3bar)
Diámetro orificio: 35 mm





Tendencia diseño

146	Icon
147	Mythos
148	Atlas Neo Sensor
151	Atlas Neo
153	Eos
156	Active
162	Tango
163	Active Twist
164	Active Plus Pull Out
165	Active Plus
167	Active Neo
168	Neptune
169	Sirius
170	Urban
171	Active Window
172	Neptune Window
173	Atlas Neo Window
174	Urban
175	Ambient
176	Trams
177	Lina





Cubetas

Fregaderos

Girfos

Campanas

Electrodomésticos

Gestión de residuos

Accesorios

Icon

Cubetas

Fregaderos

Grifos

Campanas

Electrodomésticos

Gestión de residuos

Accesorios



MYTHOS



3
AÑOS
GARANTÍA



■ **ICON PULL OUT SPRAY Negro**
115.0625.190
7612985886406
607 €

■ **ICON PULL OUT SPRAY Cromado**
115.0625.188
7612985885683
549 €

Material: **Metálico**
Caño: **Extraíble con spray**
Versión spray: **Chorro - Ducha**
Manguera extensible: **Nylon negro**
Longitud manguera extensible: **1.700 mm**
Aireador: **Laminar**
Rotación cabeza: **360°**
Apertura mando: **0 / 100**
Caudal: **7.5 L/itr/min (3 bar)**
Diámetro orificio: **35 mm**

ICON PULL OUT

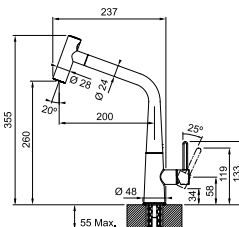



MYTHOS



3
AÑOS
GARANTÍA



MYTHOS



MYTHOS
Negro
115.0550.441
7612985552653
530 €



MYTHOS
Acero Inox
115.0547.852
7612985543453
484 €

Material: **Acero Inox 304**
Recubrimiento especial: **PVD (modelo negro)**
Caño: **Giratorio**
Aireador: **Laminar**
Rotación cabezal: **360°**
Apertura mando: **50 / 50**
Caudal: **13L/Min (3bar)**
Diámetro orificio: **35 mm**

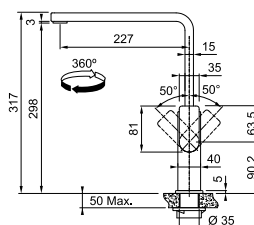

Atlas Neo

Sensor

¡Sin molestias, sin gérmenes, sin manos!



Escanea el QR para más información



Puede ser fácil ensuciarse las manos mientras se preparan las comidas, gracias al Atlas Neo Sensor no hace falta tocar el grifo para activar el agua, permitiendo una mejor higiene para ti y tu familia. Además, este grifo moderno y de alta tecnología ahorra agua y energía, ya que detiene automáticamente el flujo de agua después de 30 segundos.

Práctico

Tan solo coloca tu mano cerca del sensor, sin necesidad de pulsar ningún botón ni tirar de la maneta y disfruta por 30 segundos del agua del grifo.



Cuida el medio ambiente y tu bolsillo

Coloca la sartén debajo del grifo, actívalo y olvídate de él, el flujo de agua se detiene automáticamente después de 30 segundos, ahorrando agua y energía.



Tal como te gusta

Puedes elegir la temperatura ideal cuando actives el grifo. Si quieres agua más caliente o fría sólo tienes que ajustar la maneta.

Higiénico

La cocina es uno de los ambientes más utilizados en casa y nunca se es demasiado precavido en lo que a higiene se refiere. Al evitar el uso manual, tendrás menos riesgo de contaminar con virus o bacterias la maneta del grifo.

Estilo sin limitaciones

¿Por qué conformarse con un solo estilo? Combina el color de tu cocina con el moderno negro mate o el clásico cromado.

Notarás la diferencia en beneficios, no en tamaño

Rápido y fácil de instalar, nuestro grifo Atlas Neo Sensor cuenta con una caja de control que ocupa muy poco espacio bajo el fregadero.



Beneficios

Atlas Neo Sensor



Cubetas

Fregaderos

Grifos

Campanas

Electrodomésticos

Gestión de residuos

Accesorios

MYTHOS



GERMAN DESIGN AWARD SPECIAL 2022



3 AÑOS GARANTÍA



ATLAS NEO SENSOR PULL OUT



■ ATLAS NEO SENSOR PULL OUT Negro
115.0625.527
7612985886895
807 €

■ ATLAS NEO SENSOR PULL OUT Acero Inox
115.0625.523
7612985886864
761 €

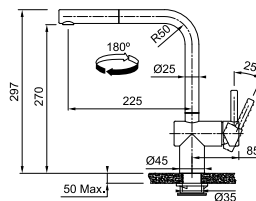

Material: **Acero Inox 304**
Recubrimiento especial: **PVD (modelo negro)**
Caño: **Extraíble**
Versión spray: **Chorro**
Manguera extensible: **Nylon gris**
Longitud manguera extensible: **1.500 mm**
Sensor por **Infrarrojos**
Aireador: **Laminar**
Rotación cabezal: **180°**
Apertura mando: **-6 / +90**
Caudal: **77,0L/Min 3bar / 4,0L/Min 3bar con apertura con sensor**
Diámetro orificio: **35 mm**

150 Colección 2023

Atlas Neo



MARIS



3
AÑOS
GARANTÍA

**ATLAS NEO
PULL OUT**



Material: Acero Inox 304
Recubrimiento especial: PVD (modelo negro)
Caño: Extraíble con spray (modelo spray)
Versión Spray: Chorro - Ducha (modelo spray)
Manguera extensible: Nylon gris
Longitud manguera extensible: 1.500 mm
Aireador: Laminar
Rotación cabezal: 180°
Apertura mando: 0 / 90
Caudal: 9.7 L/min (3 bar) (115.0550.427 y 115.0521.438) y 8.6 L/min (3 bar) (115.0521.441)
Diámetro orificio: 35 mm

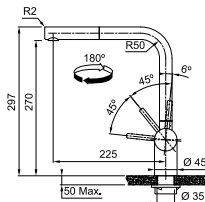

**ATLAS NEO
PULL OUT
(modelo spray)**

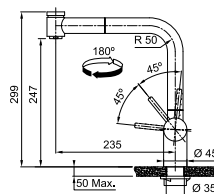

NEW



**ATLAS NEO PULL OUT
Antracita**
115.0628.210
 7612985911214
459 €

NEW



**ATLAS NEO PULL OUT
Cobre**
115.0628.208
 7612985910897
459 €

NEW



**ATLAS NEO PULL OUT
Oro**
115.0681.242
 7612986230536
459 €



**ATLAS NEO PULL OUT
Negro**
115.0550.427
 7612985552646
438 €



**ATLAS NEO PULL OUT
Acero Inox**
115.0521.438
 7612985444903
318 €



**ATLAS NEO PULL OUT SPRAY
Acero Inox**
115.0521.441
 7612985444934
341 €

Atlas Neo



MARIS



3
AÑOS
GARANTÍA

ATLAS NEO



Material: **Acero Inox 304**
Recubrimiento especial: **PVD (modelos color)**
Caño: **Giratorio**
Aireador: **Laminar**
Rotación cabezal: **180°**
Apertura mando: **0 / 90**
Caudal: **12.2L/Min (3 bar)**
Diámetro orificio: **35 mm**

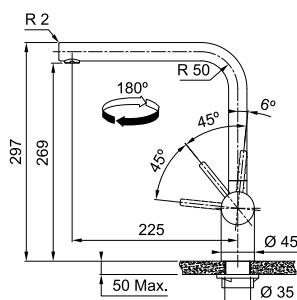

■ ATLAS NEO
Antracita
115.0628.207
7612985910880
392 €

■ ATLAS NEO
Cobre
115.0628.204
7612985910866
392 €

NEW ■ ATLAS NEO
Oro
115.0681.241
7612986230529
392 €

■ ATLAS NEO
Negro
115.0550.424
7612985552639
392 €

■ ATLAS NEO
Acero Inox
115.0521.435
7612985444873
272 €



MYTHOS



3
AÑOS
GARANTÍA

EOS PULL OUT



Material: **Acero Inox 304**
 Recubrimiento especial: **PVD**
 Caño: **Extraíble con Spray**
 Versión Spray: **Chorro - Ducha**
 Manguera extensible: **Nylon negro**
 Longitud manguera extensible:
1.800 mm
 Aireador: **Laminar**
 Rotación cabezal: **180°**
 Apertura mando: **-6 / +90**
 Caudal: **10.0 L/Min (3 bar)**
 Diámetro orificio: **35 mm**

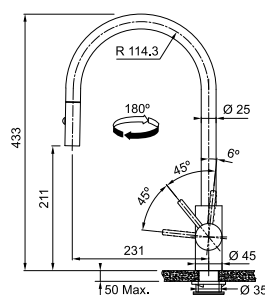

 EOS PULL OUT
Negro Industrial
115.0613.671
 7612985820479
438 €

 EOS PULL OUT
Antracita
115.0628.256
 7612985911276
438 €

 EOS PULL OUT
Cobre
115.0628.254
 7612985911252
438 €

 **NEW** EOS PULL OUT
Oro
115.0681.244
 7612986230550
438 €



MARIS



3
AÑOS
GARANTÍA

**EOS NEO
PULL OUT**

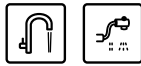

Material: **Acero Inox 304**
 Caño: **Extraíble con spray**
 Versión Spray: **Chorro - Ducha**
 Manguera extensible: **Nylon negro**
 Longitud manguera extensible:
1.800 mm
 Aireador: **Laminar**
 Rotación cabezal: **180°**
 Apertura mando: **-6 / +90**
 Caudal: **10.0L/Min (3bar)**
 Diámetro orificio: **35 mm**



EOS NEO PULL OUT
Acero Inox
115.0590.045
 7612985727990
357 €

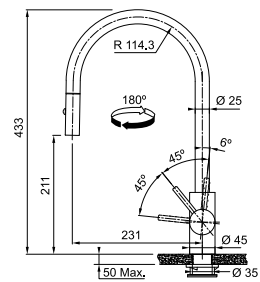

MARIS



3
AÑOS
GARANTÍA

EOS NEO



Material: **Acero Inox 304**
 Caño: **Giratorio**
 Aireador: **Laminar**
 Rotación cabezal: **180°**
 Apertura mando: **-6 / +90**
 Caudal: **12.0L/Min (3bar)**
 Diámetro orificio: **35 mm**



EOS NEO
Acero Inox
115.0590.044
 7612985727983
265 €

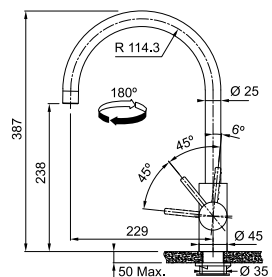



MYTHOS



NEW

3
AÑOS
GARANTÍA

EOS NEO
SWIVEL



Material: **Acero Inox 304**
 Recubrimiento especial: **PVD**
 Caño: **Giratorio**
 Aireador: **Laminar**
 Rotación cabezal: **180°**
 Apertura mando: **0 / 90**
 Caudal: **12 L/Min (3 bar)**
 Diámetro orificio: **35 mm**

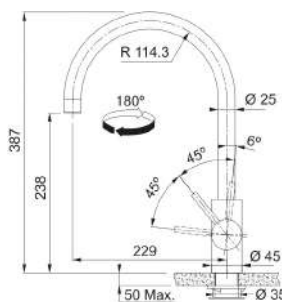

- EOS NEO SWIVEL Negro Industrial**
115.0613.590
 7612985820462
309 €
- EOS NEO SWIVEL Antracita**
115.0628.253
 7612985911245
309 €
- EOS NEO SWIVEL Cobre**
115.0628.251
 7612985911221
309€
- EOS NEO SWIVEL Oro**
115.0681.243
 7612986230543
309 €

Grifos

Active

Diseño excepcional, por dentro y por fuera.
La gama de grifos con alma sostenible



Sostenibilidad con estilo

Escanea el QR para más información



Cubetas

Fregaderos

Grifos

Campanas

Electrodomésticos

Gestión de residuos

Accesorios

Cartucho ECO Ahorro de agua hasta un 50%



El objetivo principal de nuestros grifos es ofrecer lo mejor de dos mundos diseño y sostenibilidad. Con dos opciones de diseño cuello cines J o cuello en L, disponibles en una gama de acabados contemporáneos; chorro de agua cristalino y sin salpicaduras gracias a su aireador laminar; función "Spray Jet" para una limpieza precisa y un cartucho ECO que es capaz de limitar el caudal y temperatura del agua para ayudar al medio ambiente.



Active Semi Pro

El "Arco del Triunfo" de los grifos.



-  Cromo
-  Negro mate

Grifo Active caño J

Disponible en una gama de colores contemporáneos.



-  Negro mate
-  Blanco Mate

Grifo Active caño L

Disponible en varios tonos suaves y sofisticados



-  Cromo
-  Negro mate
-  Stone
-  Inox óptico
-  Blanco Polar
-  Blanco Mate
-  Café Creme
-  Oyster
-  Onyx

La eficiencia de la sostenibilidad, hecha a la perfección

Cómo ajustar el cartucho

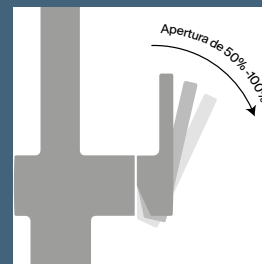

Buena potencia de agua inclusive con apertura a 50%

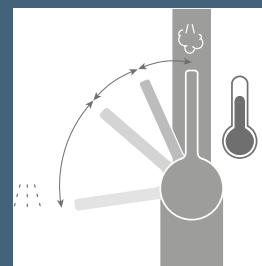

Quita la maneta y gira el anillo interior para limitar la temperatura del flujo de agua.*

*Sigue siempre las instrucciones del manual de usuario y de instalación

Active

Twist

¿Creías que lo sabías todo sobre los grifos?
Pregúntatelo de nuevo





Con Active Twist, hemos creado un grifo que funciona de manera diferente; con la habilidad no solo para llenar el fregadero, sino también para vaciarlo. Además de su aspecto elegante y minimalista, hemos incorporado una característica especial e innovadora que conecta el grifo con el fregadero por medio de una maneta giratoria, que al girarla abre la salida del desagüe (la válvula), de manera que el agua se drena de manera fácil, segura y de forma higiénica, sin tener que meter las manos en agua caliente y o sucia.

Prestaciones y beneficios

Innovador sistema de apertura "Twist" de la válvula

El diseño "todo en uno" del grifo incluye una maneta especial que cuando se gira, abre o cierra la válvula, por lo que el agua se drena fácilmente, de forma segura e higiénica, sin que tengas que meter las manos en el fregadero.

Cartucho ECO

Diseñado para limitar tanto el caudal del agua como la temperatura, el Cartucho ECO ayuda a ahorrar agua y energía. Gracias a la maneta con diferentes posiciones de apertura, es posible reducir el consumo de agua hasta en un 50%.

Función Spray Jet

Gracias a la gran potencia del flujo del caudal del agua, la función "Spray Jet" facilita el enjuague de frutas y verduras, eliminando la suciedad más incrustada de los platos, además de abarcar una amplia zona de lavado llegando a cada rincón del fregadero, haciendo que la limpieza del mismo se realice de una manera mucho más fácil.

Aireador laminar

El aireador laminar instalado en el cabezal del grifo, asegura que el Active Twist ofrezca un agua cristalina, sin salpicaduras, sin generar ruido.

Diseño de fácil limpieza

El diseño curvilíneo del Active Twist y los bordes y juntas del grifo redondeados, facilitan su limpieza.

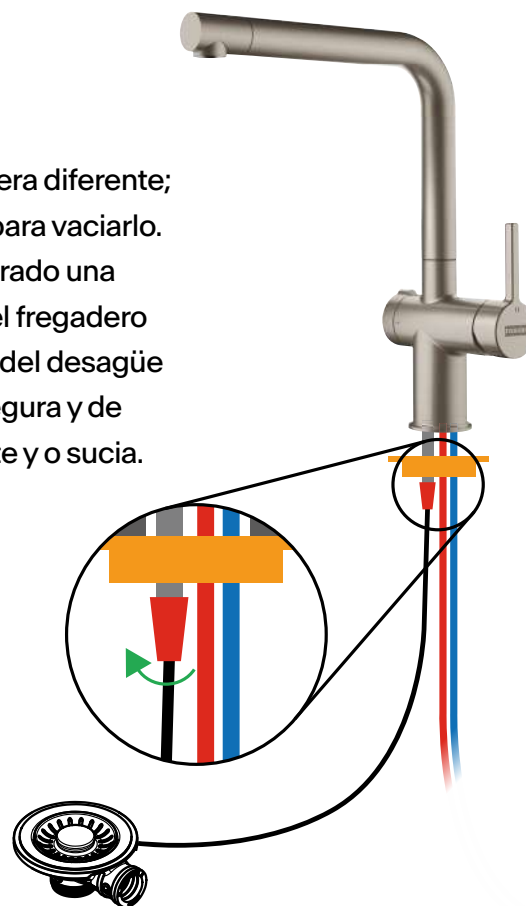

Fregaderos Acero Inox compatibles con Active Twist

¿Cuál es la mejor manera de sacar provecho de los fregaderos de acero inoxidable? Añadiendo el fantástico e innovador diseño de la gama de grifos Active Twist.



Cubetas Mythos

Mod: MYX



Cubetas Box

Mod: BXX



Planar

Mod: PPX



Aton

Mod: ANX



Cubetas Maris

Mod: MRX



Progresso Angular

Mod: PNX

Fregaderos Fraganite compatibles con Active Twist

El elegante acabado negro mate de los fregaderos Fraganite, se convierte en el foco de tu cocina. Deja que Active Twist añada más estilo a la misma.



Kubus 2

Mod: KNG



Mythos

Mod: MTG



Cubetas Maris

Mod: MRG



Fregaderos Maris

Mod: MRG



Centro

Mod: CNG



Urban

Mod: UBG

Conjunto de válvula en Acero Inox y Colorline (negro mate) compatibles con Active Twist

Combina el modelo de fregadero o cubeta con el grifo Active Twist y descubre qué conjunto de válvula de acero inoxidable necesitas. Para los que prefieren el negro mate de la gama Colorline, será necesario pedir: conjunto válvula, rebosadero y tapa embellecedora de la válvula, según modelo.



Familias de Producto en Acero Inox / Fraganite	Modelos compatibles	Extraíble con Spray 115.0653.505	Swivel Spout 115.0653.504	Extraíble con Spray 115.0669.769
Cubetas Box (con válvula integrada)	Todas las BXX	112.0301.673	112.0301.673	
Planar Zero	Todos los PPX excepto los modelos con pestaña (PPX-210-78 TL)	112.0301.696	112.0301.696	
Aton	Todos los ANX excepto el ANX 251	112.0301.698	112.0301.698	
Cubetas Maris	Todas las cubetas MRX (No Fregaderos MRX)	112.0301.698	112.0301.698	
Progresso Angular	Todas PNX	112.0332.278	112.0332.278	
Kubus 2 Fraganite	Todos los KNG excepto modelo KNG 110-62	112.0389.090	112.0389.090	112.0389.090 133.0668.855 112.0670.893
Mythos Fraganite	Todos los MTG	112.0389.090	112.0389.090	112.0656.939 133.0668.854
Cubetas Maris Fraganite	Todas las MRG	112.0544.161	112.0544.161	112.0656.939 133.0668.855 112.0657.146
Fregaderos Maris Fraganite	Todos los MRG	112.0544.161	112.0544.161	
Fregaderos Maris Fraganite	Todos los MRG			112.0656.939 133.0668.854
Fregaderos Centro Fraganite	Todos los CNG	112.0544.161	112.0544.161	
Urban	Todos los UBG	112.0544.161	112.0544.161	112.0656.939 133.0668.854

Tango



MYTHOS



TANGO NEO
PULL OUT



TANGO NEO PULL OUT
Acero Inox
115.0596.388
7612985750431
357 €

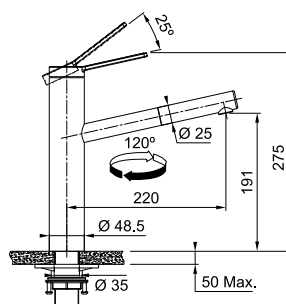

Material: **Acero Inox 304**
Caño: **Extraíble**
Versión spray: **Chorro**
Manguera extensible: **Nylon negro**
Longitud manguera extensible: **1.500 mm**
Ahorro de agua: **Cartucho Eco**
Aireador: **Laminar**
Rotación cabezal: **120°**
Apertura mando: **5 / 45 movimiento lateral; 0 / 25 arriba - abajo**
Caudal: **9.0 ltr/miun (3 bar)**
Diámetro orificio: **35 mm**



Beneficios

Active Twist



Cubetas

Fregaderos

Girifos

Campanas

MARIS



3
AÑOS
GARANTÍA

ACTIVE TWIST
PULL OUT

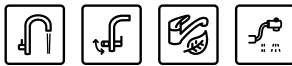

Material: **Metálico**
Caño: **Extraíble con spray**
Versión Spray: **Chorro - Ducha**
Manguera extensible: **Nylon negro**
Longitud manguera extensible: **1.500 mm**
Ahorro de agua: **Cartucho Eco**
Aireador: **Laminar**
Rotación cabezal: **180°**
Apertura mando: **0 / 100**
Caudal: **7.5L/min (3 bar) (Mix)**
Diámetro orificio: **35 mm**

ACTIVE TWIST PULL OUT
Negro Mate
115.0669.769
7612986172409
714 €

ACTIVE TWIST PULL OUT
Inox Óptico
115.0653.505
7612986056884
656 €

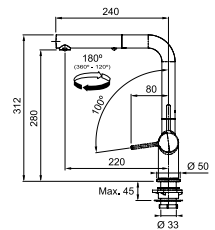

Electrodomésticos

MARIS



3
AÑOS
GARANTÍA

ACTIVE TWIST



Material: **Metálico**
Caño: **Giratorio**
Ahorro de agua: **Cartucho Eco**
Aireador: **Laminar**
Rotación cabezal: **180°**
Apertura mando: **0 / 100**
Caudal: **8.3L/min (3 bar) (Mix)**
Diámetro orificio: **35 mm**

ACTIVE TWIST
Inox Óptico
115.0653.504
7612986056891
576 €

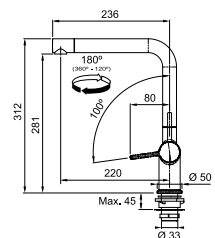

Gestión de residuos

Accesorios

Active Plus Pull Out



MARIS



- ACTIVE PLUS PULL OUT Negro Mate**
115.0653.382
 7612986056396
473 €
- ACTIVE PLUS PULL OUT Blanco Mate**
115.0653.383
 7612986056402
473 €
- ACTIVE PLUS PULL OUT Onyx**
115.0653.384
 7612986056419
380 €

- ACTIVE PLUS PULL OUT Stone Grey**
115.0653.385
 7612986056426
380 €
- ACTIVE PLUS PULL OUT Blanco Polar**
115.0653.387
 7612986056440
380 €
- ACTIVE PLUS PULL OUT Café Creme**
115.0653.388
 7612986056457
380 €
- ACTIVE PLUS PULL OUT Oyster**
115.0653.389
 7612986056464
380 €

Material: Metálico
Caño: Extraíble con spray
Versión Spray: Chorro - Ducha
Manguera extensible: Nylon gris
Longitud manguera extensible: 1.700 mm
Ahorro de agua: Cartucho Eco
Aireador: Laminar
Rotación cabezal: 180°
Apertura mando: 0 / 100
Caudal: 7.5L/min (3 bar) (Mix)
Diámetro orificio: 35 mm

3
AÑOS
GARANTÍA

**ACTIVE PLUS
PULL OUT**

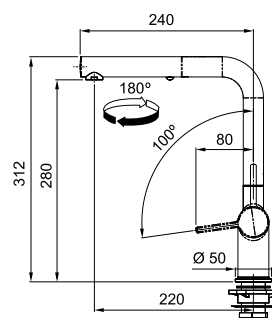

Active Plus



MARIS



 **ACTIVE PLUS Negro Mate**
115.0653.371
7612986056082
380 €

 **ACTIVE PLUS Blanco Mate**
115.0653.372
7612986056099
380 €

 **ACTIVE PLUS Onyx**
115.0653.373
7612986056303
288 €

 **ACTIVE PLUS Stone Grey**
115.0653.374
7612986056310
288 €

 **ACTIVE PLUS Blanco Polar**
115.0653.376
7612986056334
288 €

 **ACTIVE PLUS Café Creme**
115.0653.377
7612986056341
288 €

 **ACTIVE PLUS Oyster**
115.0653.378
7612986056358
288 €

Material: **Metálico**
Caño: **Giratorio**
Ahorro de agua: **Cartucho Eco**
Aireador: **Laminar**
Rotación cabezal: **180°**
Apertura mando: **0 / 100**
Caudal: **8.3L/min (3 bar) (Mix)**
Diámetro orificio: **35 mm**

3
AÑOS
GARANTÍA

ACTIVE PLUS

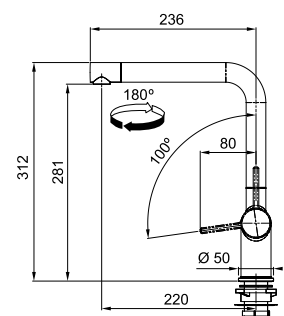

Active Plus

Cubetas

Fregaderos

Grifos

Campanas

Electrodomésticos

Gestión de residuos

Accesorios



MARIS



3
AÑOS
GARANTÍA

**ACTIVE PLUS
SWIVEL**

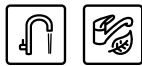

Material: **Metálico**
Caño: **Giratorio**
Ahorro de agua: **Cartucho Eco**
Aireador: **Laminar**
Rotación cabezal: **180°**
Apertura mando: **0 / 100**
Caudal: **8.3L/min (3 bar) (Mix)**
Diámetro orificio: **35 mm**

ACTIVE PLUS SWIVEL L
Cromado
115.0653.298
7612986056051
242 €

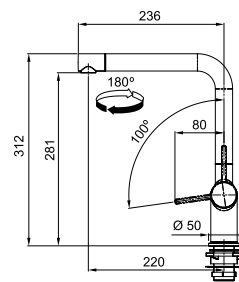

MARIS



3
AÑOS
GARANTÍA

**ACTIVE PLUS
PULL OUT SPRAY**



Material: **Metálico**
Caño: **Extraíble con spray**
Ahorro de agua: **Cartucho Eco**
Longitud de la manguera extensible: **1700 mm**
Aireador: **Laminar**
Rotación cabezal: **180°**
Apertura mando: **0 / 100**
Caudal: **8.3L/min (3 bar) (Mix)**
Diámetro orificio: **35 mm**

ACTIVE PLUS PULL OUT
Cromado
115.0653.379
7612986056365
334 €

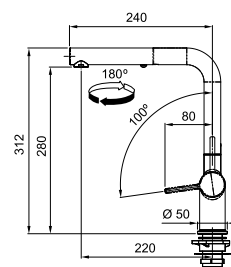

Active Neo



MARIS



3
AÑOS
GARANTÍA

ACTIVE NEO
PULL OUT



Material: **Metálico**
Caño: **Extraíble con spray**
Versión Spray: **Chorro - Ducha**
Manguera extensible: **Nylon gris**
Longitud manguera extensible: **2.000 mm**
Ahorro de agua: **Cartucho Eco**
Aireador: **Laminar**
Rotación cabezal: **180°**
Apertura mando: **0 / 100**
Caudal: **7.5L/min (3 bar) (Mix)**
Diámetro orificio: **35 mm**

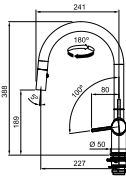

ACTIVE NEO PULL OUT
Negro Mate
115.0653.404
7612986056594
426 €

MONOMANDO ACTIVE NEO
PULL OUT WH MATE II
Blanco Mate
115.0653.405
7612986056600
426 €

MARIS



3
AÑOS
GARANTÍA

ACTIVE NEO



Material: **Metálico**
Caño: **Giratorio**
Ahorro de agua: **Cartucho Eco**
Aireador: **Laminar**
Rotación cabezal: **180°**
Apertura mando: **0 / 100**
Caudal: **8.3L/min (3 bar) (Mix)**
Diámetro orificio: **35 mm**

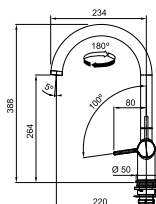

ACTIVE NEO
Negro Mate
115.0653.398
7612986056549
311 €

ACTIVE NEO
Blanco Mate
115.0653.399
7612986056556
311 €

Neptune

Cubetas

Fregaderos

Grifos

Campanas



MARIS



3
AÑOS
GARANTÍA

NEPTUNE EVO
PULL OUT



Material: **Metálico**
Caño: **Extraíble**
Versión Spray: **Chorro**
Manguera extensible: **Nylon gris**
Longitud manguera extensible: **1.500 mm**
Rotación cabezal: **360°**
Apertura mando: **45 / 45**
Caudal: **9,5 ltr/min (3 bar)**
Diámetro orificio: **35 mm**

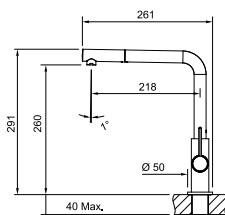

NEPTUNE EVO PULL OUT
Cromado/Negro
115.0373.945
7612981603052
322 €

NEPTUNE EVO PULL OUT
Cromado
115.0373.943
7612981603038
284 €

MARIS



3
AÑOS
GARANTÍA

NEPTUNE EVO



Material: **Metálico**
Caño: **Giratorio**
Rotación cabezal: **360°**
Apertura mando: **45 / 45**
Caudal: **11,7 ltr/min (3 bar)**
Diámetro orificio: **35 mm**

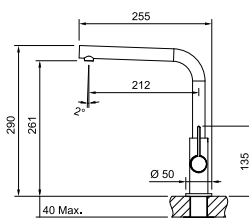

NEPTUNE EVO
Cromado/Negro
115.0373.930
7612981602987
276 €

NEPTUNE EVO
Cromado
115.0373.928
7612981602963
253 €

Electrodomésticos

Gestión de residuos

Accesorios



Fregadero no disponible en este catálogo

MARIS



- SIRIUS PULL OUT Cromado**
115.0668.280
 7612986165005
219 €
- SIRIUS PULL OUT Blanco**
115.0668.382
 7612986165029
259 €
- SIRIUS PULL OUT Onyx**
115.0668.279
 7612986163698
259 €

Material: **Metálico**
 Caño: **Extraíble**
 Material manguera extensible: **Nylon gris**
 Longitud manguera extensible: **1.500 mm**
 Rotación cabeza: **360°**
 Apertura mando: **45 / 45**
 Caudal: **9.6L/min (3 bar)**
 Diámetro orificio: **35 mm**

3
 AÑOS
 GARANTÍA

**SIRIUS
 PULL OUT**

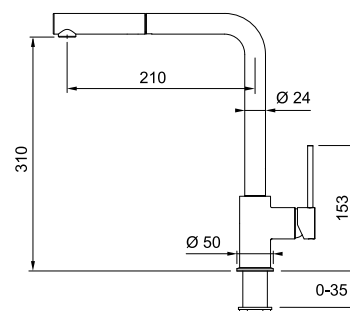

Urban

Cubetas

Fregaderos

Grifos

Campanas

Electrodomésticos

Gestión de residuos

Accesorios



MARIS



Material: **Metálico**
 Caño: **Extraíble**
 Manguera extensible: **Nylon gris**
 Longitud manguera extensible:
1.600 mm
 Rotación cabezal: **150°**
 Apertura mando: **-10 / 80**
 Caudal: **9L/Min (3bar)**
 Diámetro orificio: **35 mm**

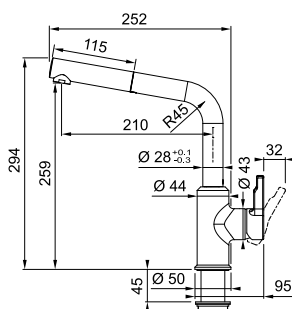

3
 AÑOS
 GARANTÍA

URBAN
PULL OUT L

170 Colección 2023

- URBAN PULL OUT L**
Negro Mate
115.0627.523
 7612985907385
249 €
- URBAN PULL OUT L**
Onyx
115.0595.091
 7612985745369
214 €
- URBAN PULL OUT L**
Stone Grey
115.0595.089
 7612985745345
214 €
- URBAN PULL OUT L**
Blanco Polar
115.0595.088
 7612985745338
214 €
- URBAN PULL OUT L**
Oyster
115.0595.093
 7612985745383
214 €

Active Window

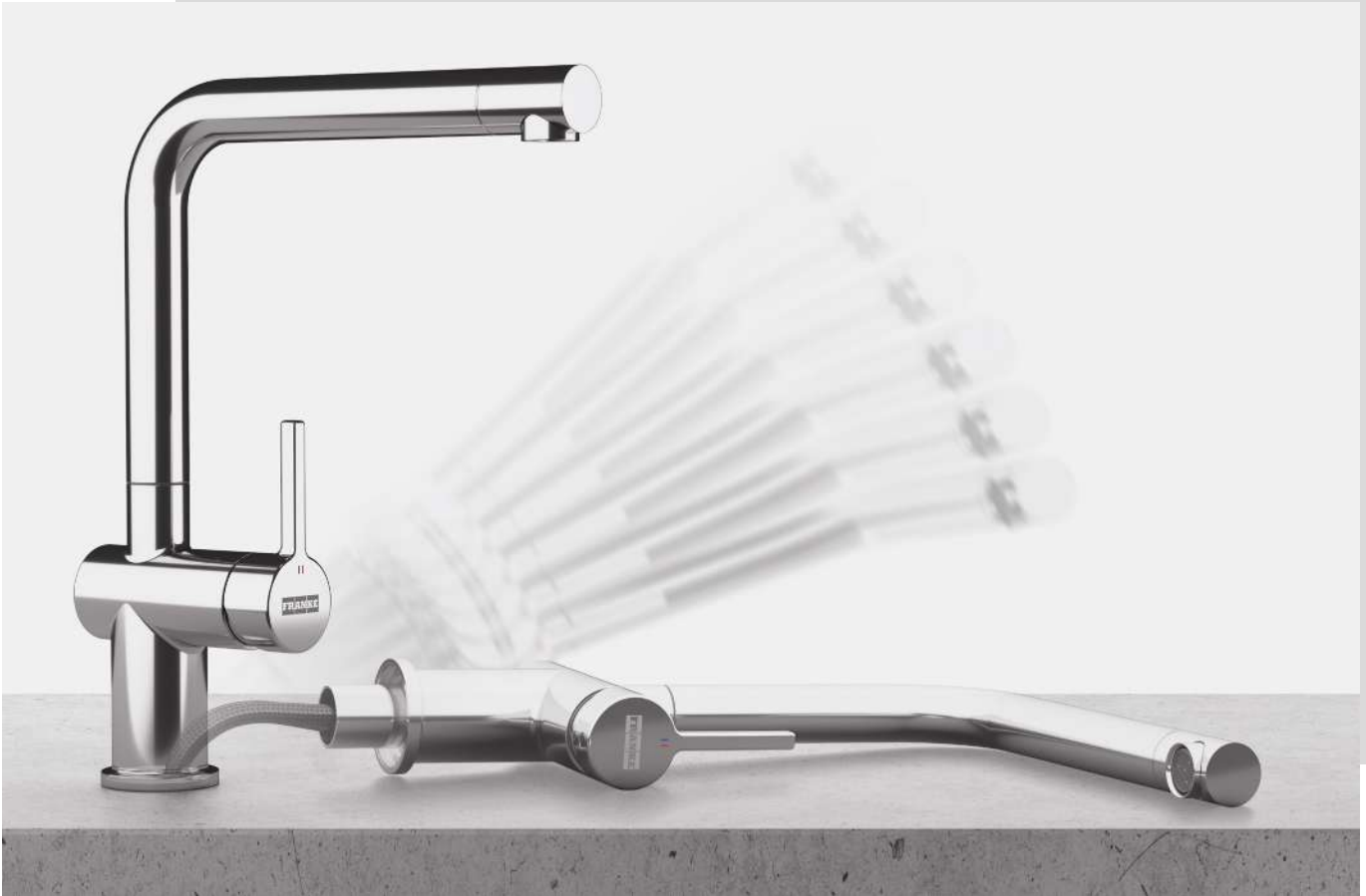

MARIS



3
AÑOS
GARANTÍA

Solución ventana
**ACTIVE NEO
PULL OUT**



Material: **Metálico**
Caño: **Extraíble solución ventana**
Versión Spray: **Chorro - Ducha**
Manguera extensible: **Nylon gris**
Longitud manguera extensible:
1.700 mm
Ahorro de agua: **Cartucho Eco**
Aireador: **Laminar**
Rotación cabezal: **180°**
Apertura mando: **0 / 100**
Caudal: **7.5L/min (3 bar) (Mix)**
Diámetro orificio: **35 mm**

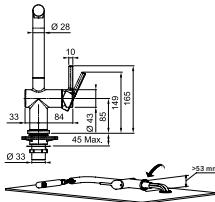

**ACTIVE L WINDOW PULL OUT
Cromado**
115.0653.391
7612986056488
553 €

MARIS



3
AÑOS
GARANTÍA

Solución ventana
ACTIVE NEO



Material: **Metálico**
Caño: **Giratorio solución ventana**
Ahorro de agua: **Cartucho Eco**
Aireador: **Laminar**
Rotación cabezal: **180°**
Apertura mando: **0 / 100**
Caudal: **8.3L/min (3 bar) (Mix)**
Diámetro orificio: **35 mm**

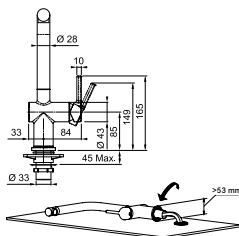

**ACTIVE L WINDOW
Cromado**
115.0653.390
7612986056471
473 €

Cubetas

Fregaderos

Grifos

Campanas

Electrodomésticos

Gestión de residuos

Accesorios

Neptune Window

Cubetas

Fregaderos

Grifos

Campanas

Electrodomésticos

Gestión de residuos

Accesorios



MARIS



3
AÑOS
GARANTÍA

Solución ventana
**NEPTUNE STYLE
WINDOW**



NEPTUNE STYLE WINDOW
Cromado
115.0263.158
7612980937677
334 €

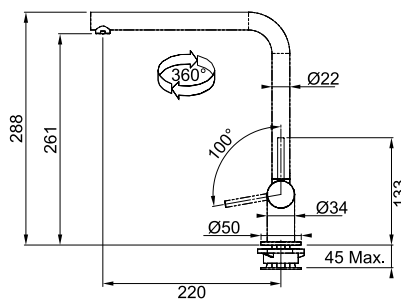

Material: **Metálico**
Rotación cabezal: **360°**
Apertura mando: **0 / 100**
Caudal: **10L/Min (3 bar)**
Diámetro orificio: **35 mm**
Altura abatido: **80 mm (caño y mando)**

Atlas Neo Window



MARIS



3
AÑOS
GARANTÍA

Solución ventana
ATLAS NEO
WINDOW



ATLAS NEO WINDOW
Acero Inox
115.0521.439
7612985444910
438 €

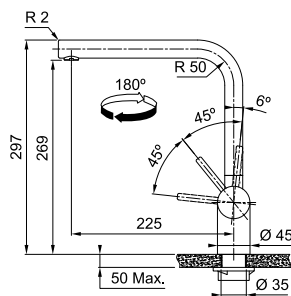

Material: **Acero Inox 304**
Caño: **Extraíble solución ventana**
Material manguera extensible:
Nylon gris
Longitud manguera Extraíble:
1500mm
Aireador: **Laminar**
Rotación cabezal: **180°**
Apertura mando: **-6 / +90**
Caudal: **8.2L/Min (3 bar)**
Diámetro orificio: **35 mm**
Altura abatido: **65 mm (caño y mando)**

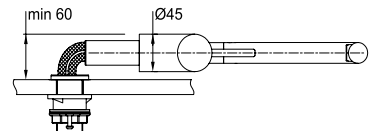

Urban

Cubetas

Fregaderos

Grifos

Campanas

Electrodomésticos

Gestión de residuos

Accesorios



MARIS



Material: **Metálico**
Caño: **Giratorio**
Rotación cabezal: **360°**
Apertura mando: **-10 / 80**
Caudal: **12 L/min (3 bar)**
Diámetro orificio: **35 mm**

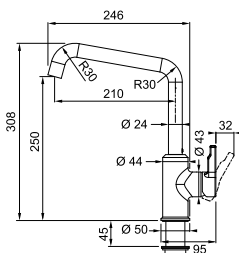

URBAN U SPOUT
Negro Mate
115.0627.524
7612985907392
214 €

URBAN U SPOUT
Cromado
115.0595.062
7612985745079
168 €

3
AÑOS
GARANTÍA

URBAN U SPOUT



MARIS



3
AÑOS
GARANTÍA

**AMBIENT
PULL OUT**



Material: **Metálico**
Caño: **Extraíble**
Versión: **Chorro**
Manguera extensible: **Nylon gris**
Longitud manguera extensible:
1.500 mm
Rotación cabezal: **360°**
Apertura mando: **45 / 45**
Caudal: **8.3L/min (3 bar)**
Diámetro orificio: **35 mm**

AMBIENT PULL OUT
Cromado
115.0373.947
7612981603069
299 €

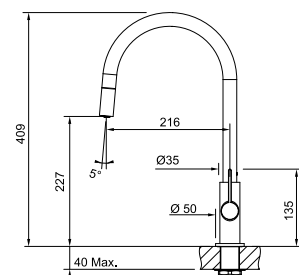

MARIS



3
AÑOS
GARANTÍA

AMBIENT



Material: **Metálico**
Caño: **Giratorio**
Rotación cabezal: **360°**
Apertura mando: **45 / 45**
Caudal: **10.7L/min (3 bar)**
Diámetro orificio: **35 mm**

AMBIENT
Cromado
115.0373.926
7612981602949
207 €

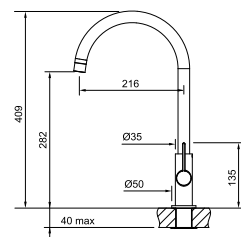

Trams

Cubetas

Fregaderos

Grifos

Campanas



SMART



3
AÑOS
GARANTÍA

SUPER TRAMS



Material: **Metálico**
Caño: **Extraíble**
Manguera extensible: **Nylon gris**
Longitud manguera extensible: **1.500 mm**
Rotación cabezal: **360°**
Apertura mando: **0 / 90**
Caudal: **10 L/min**
Diámetro orificio: **35 mm**

SUPER TRAMS
Cromado
115.0154.298
7612318269050
284 €

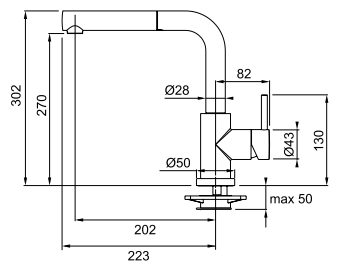

SMART



3
AÑOS
GARANTÍA

TRAMS MIX



Material: **Metálico**
Caño: **Giratorio**
Rotación cabezal: **360°**
Apertura mando: **0 / 90**
Caudal: **10 L/min**
Diámetro orificio: **35 mm**

TRAMS MIX
Cromado
115.0154.303
7612318269043
207 €

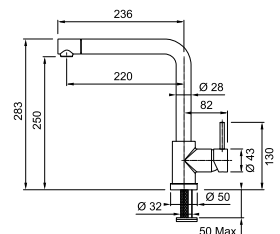

Electrodomésticos

Gestión de residuos

Accesorios



SMART



3
AÑOS
GARANTÍA

LINA PULL OUT

Material: **Metálico**
 Caño: **Extraíble**
 Versión Spray: **Chorro**
 Manguera extensible: **Nylon negro**
 Longitud manguera extensible:
1.500 mm
 Rotación cabezal: **150°**
 Apertura mando: **0 / 90**
 Caudal: **7.5 L/min (3 bar)**
 Diámetro orificio: **35 mm**

 LINA PULL OUT
Negro Mate
115.0626.053
 7612985901697
239 €

 LINA PULL OUT
Cromado
115.0693.229
 7612986294583
209 €

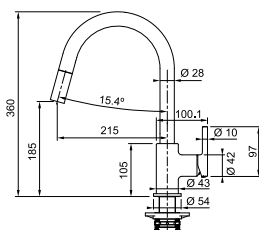

Lina

Cubetas

Fregaderos

Grifos

Campanas

Electrodomésticos

Gestión de residuos

Accesorios



SMART



LINA XL SWIVEL



Material: **Metálico**
Caño: **Giratorio**
Rotación cabeza: **360°**
Apertura mando: **0 / 90**
Caudal: **10.8 L/min (3 bar)**
Diámetro orificio: **35 mm**

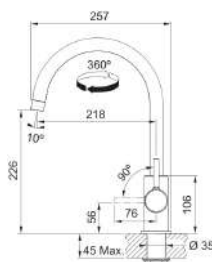

LINA XL J SWIVEL
Cromado
115.0693.228
7612986294576
169 €



SMART



LINA L SWIVEL



Material: **Metálico**
 Caño: **Giratorio**
 Rotación cabezal: **360°**
 Apertura mando: **0 / 90**
 Caudal: **9.8 L/min (3 bar)**
 Diámetro orificio: **35 mm**

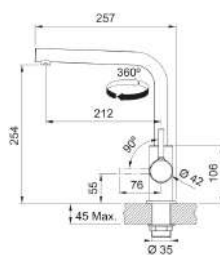

■ LINA L SWIVEL
Negro Mate
115.0693.393
 7612986295481
229 €

■ LINA L SWIVEL
Cromado
115.0693.230
 7612986294590
179 €

Cubetas

Fregaderos

Grifos

Campanas

Electrodomésticos

Gestión de residuos

Accesorios

Dispensadores de Jabón

MYTHOS



ATLAS

Material: **Acero Inox 316**
 Recubrimiento especial: **PVD (versión color)**
 Altura: **80 mm**
 Base: **Ø 50 mm**
 Válido para orificio: **Ø 24-35 mm**
 Rotación: **360°**
 Cap. Botella: **350 ml**
 Recarga: **Por medio del cabezal superior**

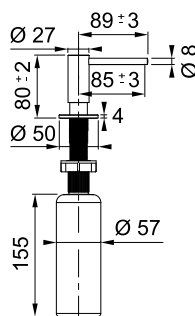

 **DISPENSADOR JABON ATLAS Acero Inox**
112.0625.483
 7612985886932
133 €

 **DISPENSADOR JABON ATLAS Negro Industrial**
112.0625.484
 7612985886949
156 €

 **DISPENSADOR JABON ATLAS Cobre**
112.0625.486
 7612985886963
156 €

 **DISPENSADOR JABON ATLAS Antracita**
112.0625.485
 7612985886956
156 €

NEW  **DISPENSADOR JABON ATLAS Oro**
112.0681.200
 7612986230512
156 €

MARIS



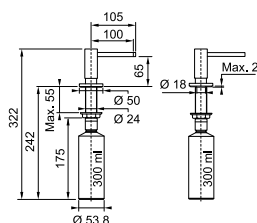

ACTIVE

Material: **Metálico**
 Altura: **80 mm**
 Base: **Ø 50 mm**
 Válido para orificio: **Ø 24-35 mm**
 Rotación: **360°**
 Cap. Botella: **300 ml**
 Recarga: **Por medio del cabezal superior**



 **DISPENSADOR JABON ACTIVE Cromado**
119.0547.902
 7612985542982
104 €

 **DISPENSADOR JABON ACTIVE Negro Mate**
119.0547.906
 7612985543811
116 €

 **DISPENSADOR JABON ACTIVE Blanco Mate**
119.0547.905
 7612985543804
116 €

SMART



SIRIUS

Material: **Metálico**
Altura: **57 mm**
Base: **Ø 47,5 mm**
Válido para orificio: **Ø 25-35 mm**
Rotación: **360°**
Cap. Botella: **350 ml**
Recarga: **Por medio del cabezal superior**

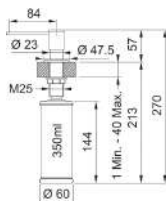

-  DISPENSADOR SIRIUS **Cromado/Blanco**
112.0622.818
7612985876148
87 €
-  DISPENSADOR SIRIUS **Cromado/ Negro**
112.0622.815
7612985876117
87 €
-  DISPENSADOR SIRIUS **Cromado**
112.0622.813
7612985875790
80 €

SMART



NOVINOX

Material: **Acero inox 316**
Altura: **57 mm**
Base: **Ø 50 mm**
Válido para orificio: **Ø 25 - 35 mm**
Rotación: **360°**
Cap. Botella: **200 ml**
Recarga: **Por medio del cabezal superior**

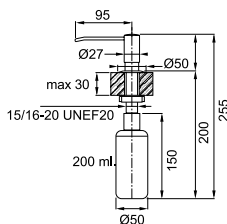

-  DISPENSADOR JABON **Acero Inox**
119.0181.657
7612980544769
99 €

SMART



NOVITA

Material: **Cromado**
Válido para orificio: **Ø 25 - 40 mm**
Rotación: **360°**
Cap. Botella: **250 ml**
Recarga: **Por medio del cabezal superior**

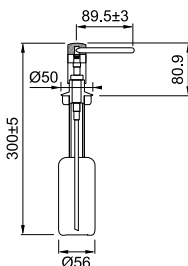

-  DISPENSADOR JABON NOVITA **Cromado**
119.0044.833
7612980383092
69 €

Cubetas

Fregaderos

Grifos

Campanas

Electrodomésticos

Gestión de residuos

Accesorios

Cubetas

Fregaderos

Grifos

Campanas

Electrodomésticos

Gestión de residuos

Accesorios



Picto gramas



Aireador laminar: garantiza un chorro más cristalino, además de reducir las salpicaduras y la generación de cal



Filtra los microplásticos



Caño alto: Para llenar cacerolas/recipientes grandes



Filtra metales pesados



Rotación 360°: Amplitud de la caída del agua para un mayor alcance



Filtra óxido y sedimentos



Doble chorro para cualquier tipo de uso: Chorro jet concentrado y chorro ducha efecto lluvia



Capacidad de filtración de 1.700 L, caudal de 6 a 10 L /min a 3 bares



Retiene la Cal



Diseñado para limitar tanto el caudal del agua como la temperatura, ayuda a ahorrar agua y energía. Gracias a la maneta con diferentes posiciones de apertura es posible reducir el consumo de agua hasta en un 50%



Elimina sabores y olores



Grifo Active Twist



Cam

panas

188	Air Hub
194	Campanas Techo
202	Campanas Isla
212	Placas con Campana
224	Campanas Pared
246	Campanas Integradas

Todas las propiedades de nuestras campanas han sido medidas según normas : UNE-EN 61591, UNE-EN 60704-2-13 y UNE-EN 60704-3 con campana en versión aspirante.





Cubetas

Fregaderos

Girfos

Campanas

Electrodomésticos

Gestión de residuos

Accesorios

Campanas

Cubetas

Fregaderos

Grifos

Campanas

Electrodomésticos

Gestión de residuos

Accesorios

Air Hub

Campanas Techo

Campanas Isla

MYTHOS

MARIS

SMART



FCMY CAH
p. 190



FVMY AS
p. 192



FTMY AS
p. 193



FCMY C
p. 196



FCMY C FL
p. 197



FCMA C
p. 198



FCAS A90
p. 199



DROP 900
p. 200



FCBI 926
p. 201



FMY F180
p. 206



FDW
p. 207



TALE 905 I
p. 208



FME 407
p. 209



FTU PLUS 3707 I
p. 210



FSMS F 42
p. 211

Placas con campana



FMY 839 HE
p. 217



FMY 839 HI 2.0
p. 219



FMA 839 HI
p. 221



FSM 709 HI
p. 223

Campanas Pared



FKAS A80
p. 228



FMY PRO 907
p. 229



FVAS A80
p. 240



FMA 907
p. 230



FCR 925 TC
p. 235



TALE
p. 236



FVAD A90
p. 239



FMA 2.0 PLUS 907
p. 242



FMA PRO
p. 243



FNO
p. 244



FSMS WALL F 42
p. 231



FSMD 508
p. 232



Trendline plus
p. 234



FDF EV8
p. 237



FDL
p. 238



FPJ
p. 245

Campanas Integradas



FSAS A
p. 248



FSO 904
p. 249



FST
p. 252



FSTPRO
p. 253



FST PLUS
p. 254



FBFE A
p. 256



FBFE A
p. 257



FSTP
p. 255



FBI
p. 258



FSM 601
p. 259



FTC
p. 259



FTC 632L
p. 259

Cubetas

Fregaderos

Girfos

Campanas

Electrodomésticos

Gestión de residuos

Accesorios

Mythos

Air Hub

El aire más puro que nunca



Cuando se piensa en la calidad del aire en la cocina suele asociarse con los olores de la cocción, pero rara vez con otros contaminantes. Nuestra nueva gama Air Hub, que combina la extracción y un sistema de purificación del aire en la campana, ofrece la solución perfecta. Con dos corrientes de aire separadas y dos luces UV-C especiales, las campanas Air Hub eliminan el 99,99% de los virus y bacterias de tu cocina, asegurando un aire puro y seguro.

Nuestras campanas Air Hub garantizan un aire limpio



Eficiencia energética y gran potencia

Nuestros motores son respetuosos con el medio ambiente y con tu bolsillo basados en su funcionamiento de bajo consumo, sin tener que sacrificar la eficiencia, gracias a su potente extractor

Sin Ozono

Los laboratorios de la Universidad de Siena han confirmado que nuestra gama Air Hub utiliza luz UV-C eliminando de forma segura virus y bacterias hasta en un 99,99% sin formación de ozono

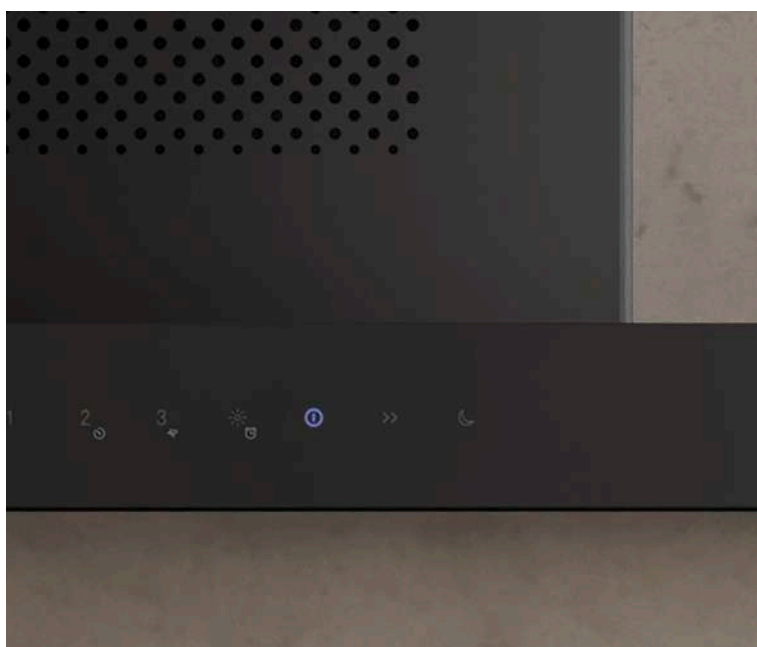

Función de purificación del aire

ⓘ MANUAL

Inicia la desinfección del aire. Puedes apagar la campana manualmente o se desactivará automáticamente al cabo de 24 horas

» INTENSIVO

Máxima velocidad de desinfección en el menor tiempo posible. Esta función se desactiva automáticamente. Máximo 2 horas a 40 m³/hora

☾ MODO NOCHE

Ciclo largo para una desinfección completa con un nivel mínimo de ruido, se enciende automáticamente por la noche



Mythos Air Hub
T-shape



Mythos Air Hub
Vertical



Mythos campana
Techo

Mythos Air Hub

Campana Techo



Accesorios opcionales



144

Set de 4 filtros
carbón activo
112.0339.360
122 €

190 Colección 2023



NEW



MYTHOS AIR HUB
FCMY CAH



FCMY 120 C WHG
Inox / Cristal Blanco
350.0679.885
7612986223057
2.199 €

Mando a distancia
incluido



Clase energética: **A+**
Ancho: **1200 mm**
Mandos: **Control a distancia**
(mando a distancia incluido)
Aspiración (mín-máx-int):
190-400-700
Presión (Pa) (mín-máx-int):
160-490-510
P. Sonora (dBA) (mín-máx-int):
43-60-72
Potencia (W) (mín-máx-int):
15-85-250
Iluminación: **Led Bar 4000K**
Filtro: **Aluminio**

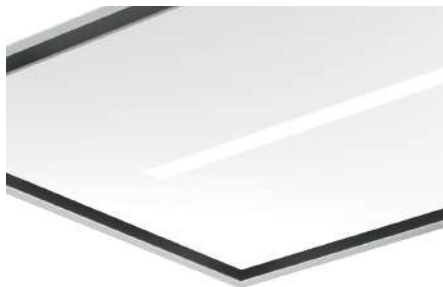
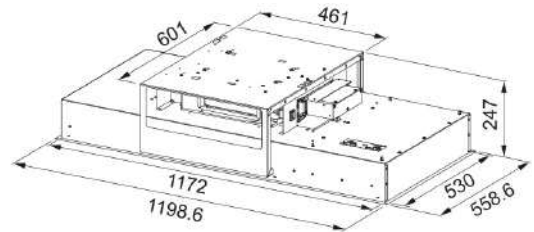

Air Hub

Campana Vertical



MYTHOS



NEW



AIR HUB
FVMY AS



Accesorios opcionales

195



Kit chimenea Ext
H2x400mm negra
112.0681.031
99 €

128



FILTRO CARBON (HP)
2 REDONDOS
D19,6cm
112.0174.995
95 €

192 Colección 2023

FVMY AS BK F90
Negro
330.0679.324
7612986221473
1.199 €

Clase energética: **A+**
Ancho: **900 mm**
Mandos: **Táctiles**
Aspiración (mín-máx-int):
280-470-800
Presión (Pa) (mín-máx-int):
150-560-600
P. Sonora (dBA) (mín-máx-int):
48-57-69
Potencia (W) (mín-máx-int):
160-230-270
Iluminación: **2x UVC Lamp**
Filtro: **Aluminio**

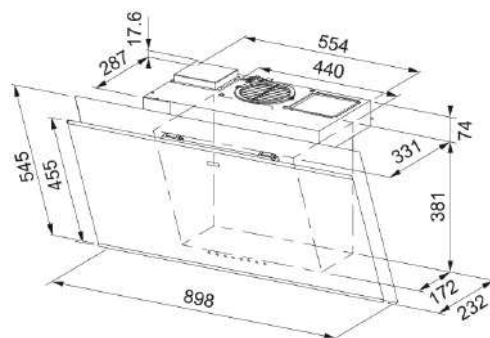

Mythos Air Hub

Campana T Invertida



MYTHOS



NEW



FTMY AS BK MATT F90
Negro Mate
325.0679.323
7612986221466
899 €

Clase energética: **A**
Ancho: **900 mm**
Mandos: **Táctiles**
Aspiración (mín-máx-int):
280-580-740
Presión (Pa) (mín-máx-int):
409-580-590
P. Sonora (dBA) (mín-máx-int):
56-68-72
Potencia (W) (mín-máx-int):
150-240-250
Iluminación: **2x UVC Lamp**
Filtro: **Aluminio + Carbón Activo**

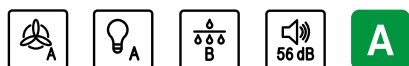

Accesorios incluidos



195
Kit chimenea Ext
H2x400mm negra
112.0681.031
99 €



196
Kit chimenea Ext
H500-500mm negra
112.0683.832
109 €

Accesorio opcional



197
Kit chimenea Ext
H500-990mm negra
112.0683.833
89 €

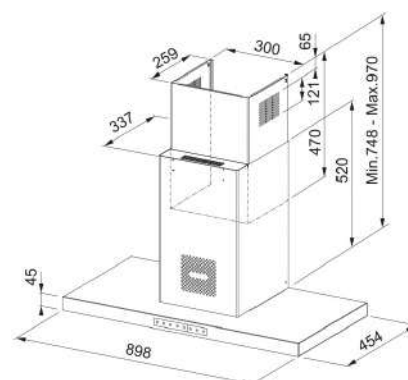

Colección 2023 **193**

Cubetas

Fregaderos

Grifos

Campanas

Electrodomésticos

Gestión de residuos

Accesorios



Campanas Techo

196
199
200
201

Mythos
AQ Sense
Drop
Maris

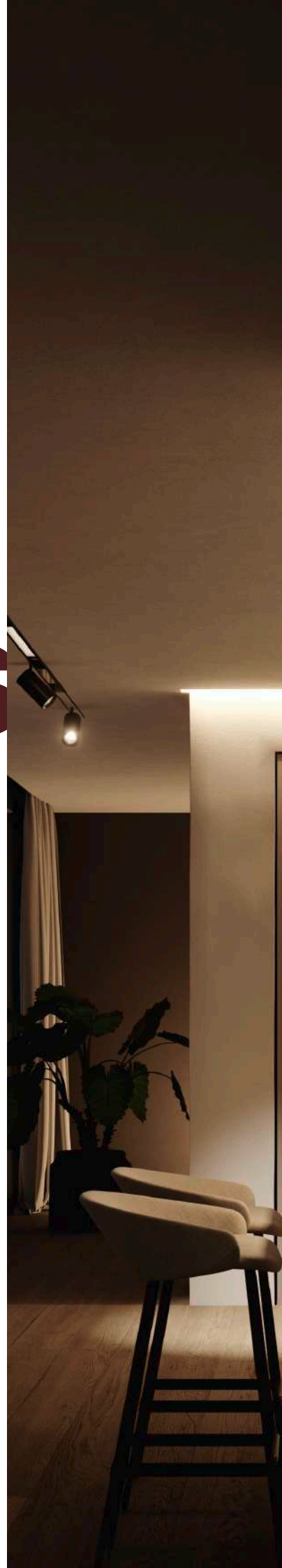



Cubetas

Fregaderos

Grifos

Campanas

Electrodomésticos

Gestión de residuos

Accesorios

Mythos

Campana Techo



MYTHOS



NEW

MYTHOS
FCMY C



Accesorio opcional

144



Set de 4 filtros
carbón activo
112.0339.360
122 €

196 Colección 2023

120 cm



FCMY 120 C XS A
Inox
350.0679.882
7612986223026
1.899 €



FCMY 120 C WHG A 2B
Cristal Blanco
350.0679.884
7612986223040
1.999 €

90 cm



FCMY 90 C XS A
Inox
350.0679.881
7612986223019
1.799 €



FCMY 90 C WHG A 2B
Cristal Blanco
350.0679.883
7612986223033
1.899 €

Clase energética: **A+**

Ancho: **1200-900 mm**

Mandos: **Control a distancia (mando a distancia incluido)**

Aspiración (mín-máx-int):

200-400-720

Presión (Pa) (mín-máx-int):

190-520-540

P. Sonora (dBA) (mín-máx-int):

43-59-72

Potencia (W) (mín-máx-int):

15-85-250

Iluminación: **2 x Led Bar Slim 4000K**

Filtro: **Aluminio**

Mando a distancia
incluido

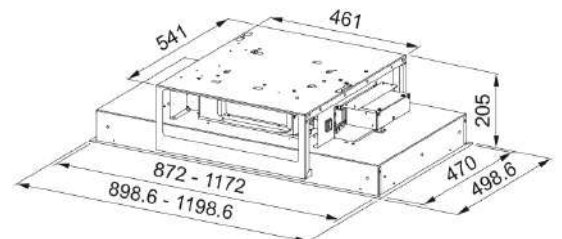

Mythos

Campana Techo

Cubetas

Fregaderos

Grifos

Campanas

Electrodomésticos

Gestión de residuos

Accesorios



MYTHOS



FCMY 90 C WHG A FL
Inox / Cristal Blanco
350.0679.886
7612986223064
1.999 €

Clase energética: **A**
Ancho: **900 mm**
Mandos: **Control a distancia (mando a distancia incluido)**
Aspiración (mín-máx-int):
200-400-720
Presión (Pa) (mín-máx-int):
190-520-540
P. Sonora (dBA) (mín-máx-int):
43-59-72
Potencia (W) (mín-máx-int):
15-85-250
Iluminación: **Panel Led**
Filtro: **Aluminio**

Mando a distancia incluido



NEW

MYTHOS
FCMY C FL



Accesorio opcional



144

Set de 4 filtros
carbón activo
112.0339.360
122 €

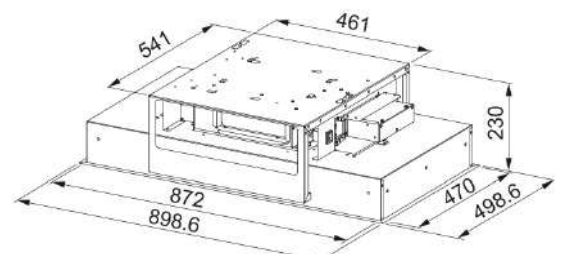

Colección 2023 **197**

AQ Sense Techo

Campana Techo



MYTHOS



FCAS A90 XS
Acero Inox
350.0657.264
7612986089967
1.720 €

Clase energética: **A**
Ancho: **900 mm**
Mandos: **Control a distancia (mando a distancia incluido)**
Aspiración (mín-máx-int): **290-610-770**
Presión (Pa) (mín-máx-int): **460-590-600**
P. Sonora (dBA) (mín-máx-int): **48-63-68**
Potencia (W) (mín-máx-int): **150-240-250**
Iluminación: **LED 2 x 3 W / 4000 K**
Filtro: **Aluminio**

Mando a distancia incluido



FCAS A90



Accesorios opcionales

144



Set de 4 filtros carbón activo
112.0339.360
122 €

156

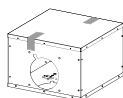

Kit instalación motor remoto Mythos
112.0327.007
230 €

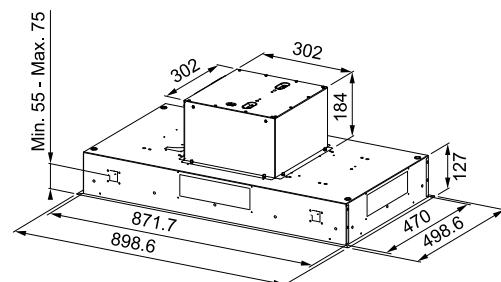

198 Colección 2023

Maris FCMA

Campana Techo



MARIS



NEW

MARIS
FCMA C



Accesorio opcional

144



Set de 4 filtros
carbón activo
112.0339.360
122 €

120 cm



FCMA 120 C XSA
Inox
350.0679.878
7612986222982
1.799 €



FCMA 120 C WHG A
Cristal Blanco
350.0679.880
7612986223002
1.949 €

90 cm



FCMA 90 C XSA
Inox
350.0679.877
7612986222975
1.699 €



FCMA 90 C WHG A
Cristal Blanco
350.0679.879
7612986222999
1.849 €

Clase energética: **A+**
Ancho: **1200-900 mm**
Mandos: **Control a distancia (mando a distancia incluido)**
Aspiración (mín-máx-int):
200-400-720
Presión (Pa) (mín-máx-int):
190-520-540
P. Sonora (dBA) (mín-máx-int):
43-59-72
Potencia (W) (mín-máx-int):
15-85-250
Iluminación: **LED 6 x 4000K**
Filtro: **Aluminio**

Mando a distancia
incluido

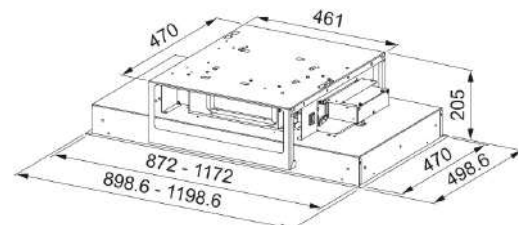

Colección 2023 **199**

Cubetas

Fregaderos

Grifos

Campanas

Electrodomésticos

Gestión de residuos

Accesorios

Drop

Campana Techo



MARIS



DROP 900 WH
Blanco
350.0562.357
 7612985626194
1.674 €

DROP 900 XS
Inox
350.0562.356
 7612985626187
1.604 €

NEW
DROP 900 BK
Negro Mate
350.0607.346
 7612985790680
1.674 €

DROP 900



Mando a distancia
 incluido



Clase energética: **A++**

Ancho: **900 mm**

Mandos: **Opción control a distancia**

Aspiración (mín-máx-int):

246-650-839

Presión (Pa) (mín-máx-int):

180-420-460

P. Sonora (dBA) (mín-máx-int):

45-63-66

Potencia (W) (mín-máx-int):

11-115-170

Iluminación: **LED 4 x 1 W (90 cm) /**

LED 6 x 1 W (120 cm)

Filtro: **Acero Inox**

Accesorio opcional

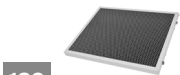

139

Filtros carbón high performance
 (debe adquirir 2 unidades)
112.0373.739
80 €

200 Colección 2023

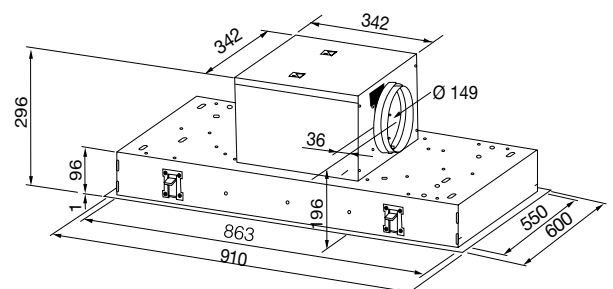

Maris

Campana Techo



MARIS



FCBI 926 WH
Blanco
350.0590.183
7612985729130
1.154 €

FCBI 926 XS
Inox
350.0590.184
7612985729147
1.096 €

Mando a distancia
incluido



Clase energética: **A**

Ancho: **900 mm**

Mandos: **Posible control a distancia**

Aspiración (mín-máx-int):

300-580-690

Presión (Pa) (mín-máx-int):

420-510-520

P. Sonora (dBA) (mín-máx-int):

49-66-69

Potencia (W) (mín-máx-int):

190-255-270

Illuminación: **LED 4 x 2 W regulable**

Filtro: **de grasa Acero Inox**

FCBI 926



Accesorios opcionales

132



Set de dos filtros de
carbón activo
112.0152.193
42 €

146



Set de dos filtros de
carbón activo larga
duración
112.0492.115
77 €

128



Set de dos filtros de
carbón activo high
performance
112.0174.995
95 €

157

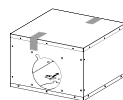

Kit instalación motor
remoto Maris
112.0599.392
230 €

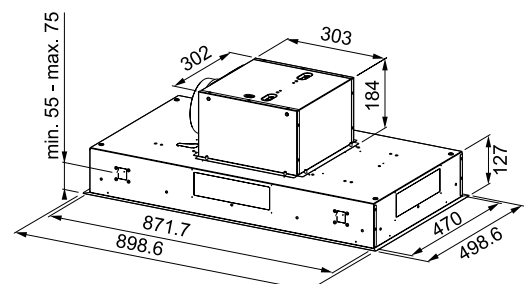

Colección 2023 **201**

Cubetas

Fregaderos

Grifos

Campanas

Electrodomésticos

Gestión de residuos

Accesorios



Campanas Isla

204

207

208

209

210

211

Mythos T-Shelf

Downdraft

Tale

Mercury

Tube Plus

Smart

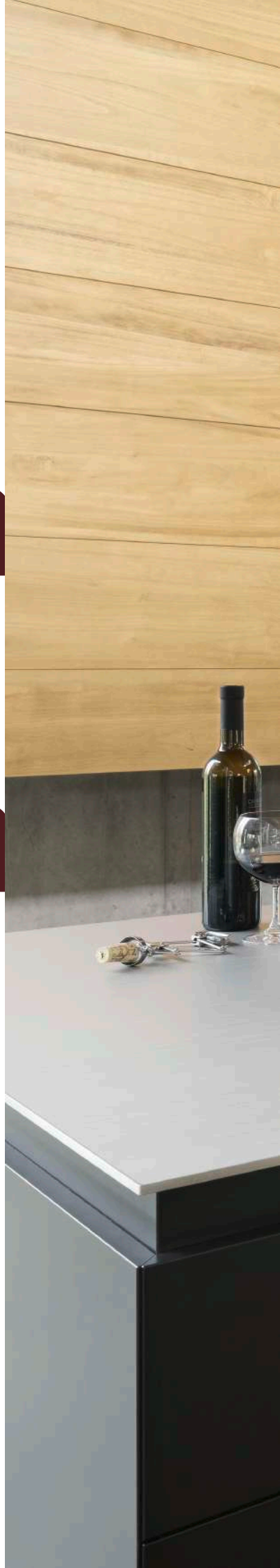



Cubetas

Fregaderos

Grifos

Campanas

Electrodomesticos

Gestión de residuos

Accesorios

Mythos

T-Shelf

Poderosa y elegante organización



El propósito de esta campaña es combinar la belleza con la funcionalidad, nuestra Mythos T-Shelf hace de este objetivo una realidad. Con un diseño industrial y estantes de cristal, combina la rigurosidad y la iluminación con una campana perfectamente funcional a 360°.



Luz LED

Crea el ambiente perfecto con dos luces LED ajustables.



Aspiración intensiva

Deshazte de los malos olores y disfruta del silencio en tu cocina con el motor SoundPro. Silencio a su máximo rendimiento.



Estilo integrado

Filtro de grasa color negro mate que combinan perfectamente con el diseño de la campana.



Estantes elegantes

Personaliza y organiza el espacio de tu cocina.

La elegancia del negro mate

Encuentra el look ideal para tu cocina.



Mythos T-Shelf

Campana Isla



Beneficios



MYTHOS



NEW

T-SHELF
FMY F180



Accesorio opcional

203



Filtro de carbón (LL)
rectangular 267 x 237 mm
112.0174.992
51 €

206 Colección 2023

FMY BK MATT F180
Negro Mate
325.0678.073
7612986216813
2.799 €

Clase energética: **A**
Ancho: **1800 mm**
Mandos: **Push-Button**
Aspiración (mín-máx-int):
280-600-750
Presión (Pa) (mín-máx-int):
450-580-590
P. Sonora (dBA) (mín-máx-int):
50-66-70
Potencia (W) (mín-máx-int):
150-240-250
Iluminación: **LED 2x Bar Slim**
4000K
Filtro: **Aluminio**

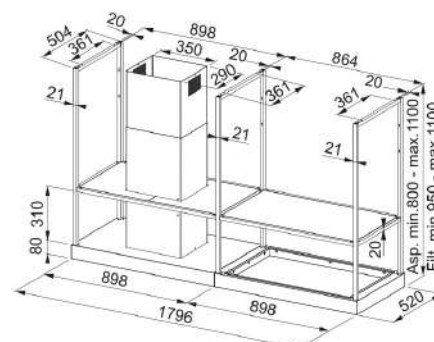

Video instalación
T-shelf

Downdraft

Campana sobremesa



MYTHOS



FDW
Negro mate
110.0365.588
7612981558802
2.199 €

Clase energética: **B**
Ancho: **800 mm**
Mandos: **Táctiles (control a distancia opcional)**
Aspiración (mín-máx-int):
200-440-720
Presión (Pa) (mín-máx-int):
100-550-590
P. Sonora (dBA) (mín-máx-int):
43-57-69
Potencia (W) (mín-máx-int):
45-170-250
Iluminación: **LED 1 x 7W**
Filtro: **Carbón activo**

DOWNDRAFT
FDW



Accesorios opcionales

138



Set de 2 filtros carbón high performance y larga duración
112.0262.703
156 €

143



Set de 2 filtros carbón larga duración
112.0289.753
7612981071523
133 €

127



Control remoto
112.0657.298
63 €

- Dimensiones de encastrado 812 x 109 mm.
- Distancia de instalación de la encimera/campana entre 3 a 5 cm máx.

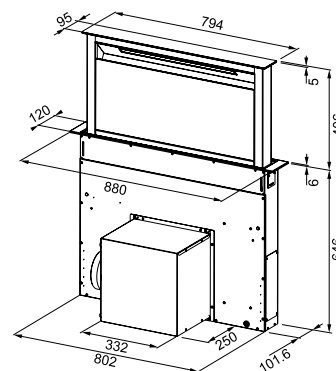

Colección 2023 **207**

Cubetas

Fregaderos

Grifos

Campanas

Electrodomésticos

Gestión de residuos

Accesorios

Tale Isla

Campana Isla



MYTHOS



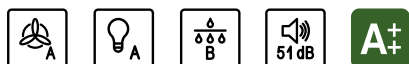

TALE 905 I



Accesorios opcionales



208 Colección 2023

	TALE ISLA 905 I BK MATT Negro Mate 325.0657.511 7612986090086 969 €	Clase energética: A++ Ancho: 900 mm Mandos: Panel de control electrónico retroiluminado Aspiración (mín-máx-int): 250-380-700 Presión (Pa) (mín-máx-int): 390-470-520 P. Sonora (dBA) (mín-máx-int): 51-59-72 Potencia (W) (mín-máx-int): 170-230-270 Iluminación: LED 4 x 1 W Filtro: de Grasa Acero Inox
	TALE ISLA 905 I XS Inox 325.0552.774 7612985566803 923 €	

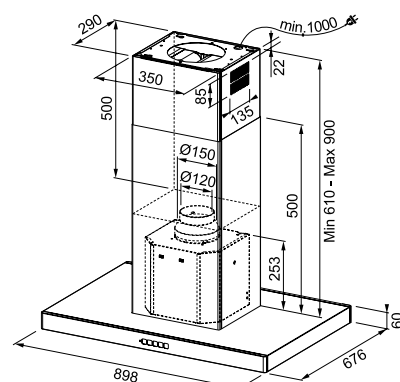

Mercury

Campana Isla

Cubetas

Fregaderos

Grifos

Campanas

Electrodomésticos

Gestión de residuos

Accesorios



MARIS



FME 407 BK
Negro
110.0260.619
7612980920754
1.062 €

Clase energética: **C**
Ancho: **400 mm**
Mandos: **Control a distancia opcional**
Aspiración (mín-máx-int):
290-570-660
Presión (Pa) (mín-máx-int):
390-500-530
P. Sonora (dBA) (mín-máx-int):
49-65-68
Potencia (W) (mín-máx-int):
130-210-250
Iluminación: **LED 1 x 2W / 4000K**
Filtro: **Carbón activo**

FME 407



49 dB



Accesorio incluido



132
Set de dos filtros de carbón activo
112.0152.193
42 €

Accesorios opcionales



146
Set de dos filtros de carbón activo larga duración
112.0492.115
77 €



128
Set de dos filtros de carbón activo high performance
112.0174.995
95 €



127
Control remoto
112.0657.298
63 €

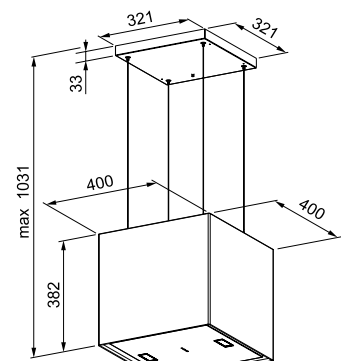

Colección 2023 **209**

Tube Plus

Campana Isla

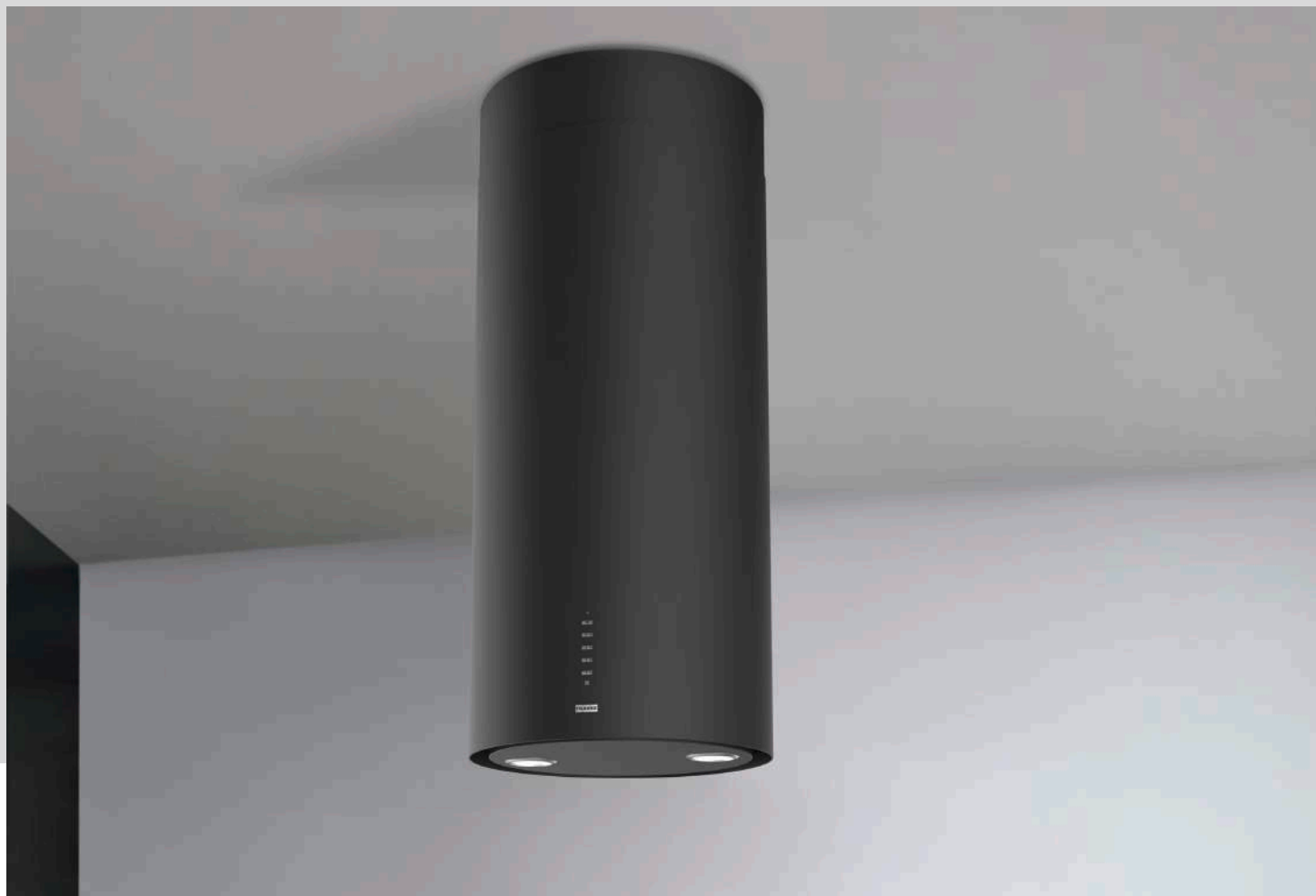

MARIS

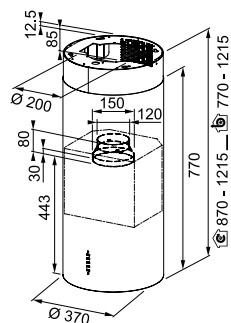

FTU PLUS 3707 I BK
Negro

335.0588.180
7612985721943
1.138 €

FTU PLUS 3707 I WH
Blanco

335.0588.222
7612985721967
1.138 €

FTU PLUS 3707 I XS
Inox

335.0588.221
7612985721950
1.092 €

Clase energética: **A**

Ancho: **370 mm**

Mandos: **Electrónicos, posible control a distancia**

Aspiración (mín-máx-int):

280-570-700

Presión (Pa) (mín-máx-int):

450-580-590

P. Sonora (dBA) (mín-máx-int):

48-65-69

Potencia (W) (mín-máx-int):

150-240-250

Iluminación: **LED 2 x 1W / 4000 K**

Filtro: **Carbón activo opcional**

TUBE PLUS
FTU PLUS
3707 I



Accesorios opcionales

134



Filtro de carbón activo
112.0151.250
30 €

145



Filtro de carbón activo
larga duración
112.0492.116
77 €

161



Prolongación canal en
inox 990 mm
112.0049.382
422 €

160



Prolongación canal en
negro 990 mm
112.0604.855
445 €

198



Prolongación canal en
blanco 990 mm
112.0615.789
445 €

127



Control remoto
112.0657.298
63 €

Smart

Campana Isla

Cubetas

Fregaderos

Grifos

Campanas

Electrodomésticos

Gestión de residuos

Accesorios



SMART



reddot winner 2022



SMART
FSMS F 42



FSMS F 42 SS/BK
Plateado
345.0654.870
7612986081763
807 €

FSMS F 42 WH
Blanco Mate
345.0654.932
7612986081770
807 €

FSMS F 42 BK
Negro Mate
345.0654.933
7612986081787
807 €

Clase energética: **A**
Ancho: **420 mm**
Mandos: **Push button**
Aspiración (mín-máx-int):
270-580-740
Presión (Pa) (mín-máx-int):
450-570-580
P. Sonora (dBA) (mín-máx-int):
52-66-70
Potencia (W) (mín-máx-int):
150-240-250
Iluminación: **LED 2 x 1 W / 3000 K**
Filtro: **Carbón activo**

Accesorio incluido

132



Set de dos filtros de
carbón activo
112.0152.193
42 €

Accesorios opcionales

146



Set de dos filtros de
carbón activo larga
duración
112.0492.115
77 €

128



Set de dos filtros de
carbón activo high
performance
112.0174.995
95 €

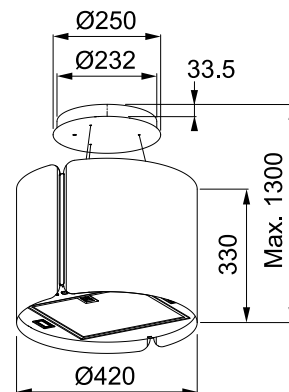

Colección 2023 **211**

Cubetas



Fregaderos

Grifos

Campanas

Electrodomésticos

Gestión de residuos

Accesorios

Placa con Campana

216
220
222

Mythos 2gether
Maris 2gether
Smart 2gether





Cubetas

Fregaderos

Grifos

Campanas

Electrodomésticos

Gestión de residuos

Accesorios

Placa con Campana

Doble ventaja



Lo mejor de los dos mundos se une de manera perfecta en una gama de placas con campana extractora. Esta innovadora solución 2 en 1 garantiza la máxima funcionalidad y libertad de diseño, gracias a que la campana pasa a ser parte de la inducción ofreciendo un aspecto amplio y placentero en tu cocina.

Es la mejor en su clase al momento de la limpieza: la superficie es fácil de limpiar y el filtro de grasa se puede limpiar en el lavavajillas. El drenaje incorporado atrapa hasta 200cl de derrames y a la vez la rejilla de hierro de la campana es resistente al calor y a los arañazos. Además, la rejilla a ras permite mover fácilmente las sartenes entre zonas de cocción sin necesidad de levantarlas.

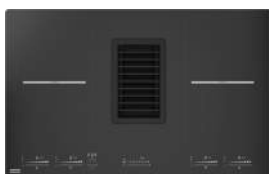
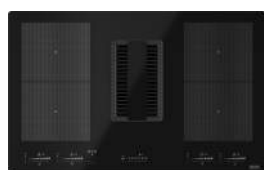

NEW

Mythos 2Gether

Elegancia absoluta y funcionalidad de primera.

La superficie de cristal negro, junto al diseño de la rejilla hace de la Mythos 2gether la solución perfecta para una cocina elegante y minimalista. Esta campana extractora está lejos de ser solamente hermosa: Tiene clase energética de A+++, aspiración de 680 mc/h y función intensiva. Consta de 4 zonas de cocción, con 2 zonas flexibles para sartenes más grandes, 9 niveles de potencia y una intensiva con temporizador en cada zona. Toda esta eficiencia viene con un nivel sonoro de tan solo 72 dB en su máxima potencia. Fácil de usar, limpiar y de amar. Esta es nuestra Mythos 2gether.

Maris 2Gether

Capaz, duradera y estéticamente hermosa.

Una inducción con 4 zonas de cocción de las cuales 2 son flexibles para dar lugar a sartenes más grandes. cuentan con control directo y un slider, 9 niveles de cocción más booster y temporizador en cada zona. Hace el arte de cocinar extremadamente sencillo y satisfactorio. El medio ambiente estará feliz, ya que nuestra Maris 2gether cuenta con clase energética A++



NEW

Smart 2Gether

Más pequeña, funcional y smart.

El diseño moderno y placentero con tan solo 70cm, hace a la Smart 2gether capaz de caber en un mueble estándar de 60cm y deja más espacio en la encimera para tus recetas. Su pequeño tamaño no la hace menos funcional: cuenta con 4 zonas de cocción y una zona flexible para sartenes más grandes, es fácil de controlar gracias a su touch directo y un slider. Ideal para cualquier preparación pues cuenta con 9 niveles de potencia más booster. La Smart 2gether es además amistosa con el medio ambiente con una clase energética A++



Mythos

2Gether

Placa de Inducción con campana extractora



Accesorios opcionales:

141



Filtro Carbon (LL)
H100
112.0548.448
7612985546614
182 €

142



Filtro Carbon (LL)
H60
112.0548.447
7612985546607
155 €

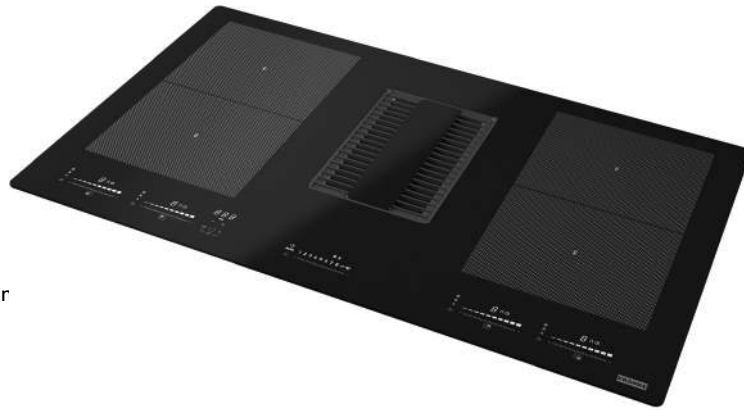

NEW

Placa de inducción con extractor
FMY 839 HE



Cristal Negro
340.0679.889
7612986223088
3.299 €

Características campana:

Acabado: **Cristal negro**
Motor: **Brushless Radical Waterproof**
Mandos campana: **Flex touch slider**
Aspiración superficial
Temporizador 15 min
Velocidades: **8+2 Int (1 Int- 10 min y 2 Int. 5 min)**
Colector de líquidos: **12 cl**
Filtro de grasa: **Aluminio multicapa**
Alarma cambio filtro grasa: **Sí**
Alarma cambio filtro carbon activo: **Sí**

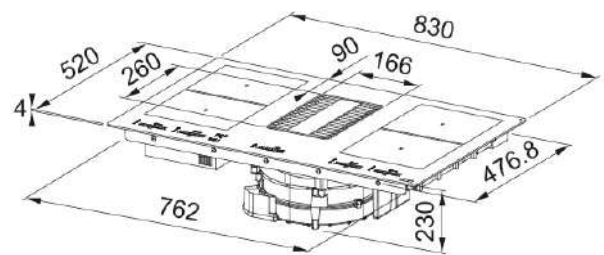

Características placa inducción:

Funciones: **Función Puente, Función Stop & Go, Calentamiento rápido**
Función Niveles de temperatura preestablecidos: **42°C fundir, 74°C mantener caliente, 92°C cocinar a fuego lento**
4 zonas de cocción:
4 zonas independientes x 184 mm x 220 mm / min Ø145 mm - máx 180 mm
2 zonas puente x 380 mm x 220 mm / min Ø110 mm - máx 245 mm
Mandos: **Flex touch slider LED blanco**
Niveles de potencia: **9 + Booster**
Indicador de calor residual
Temporizador
Bloqueo de seguridad para niños
Potencia máxima: **7,545 kW**
Dimensiones (mm): **830 x 520**

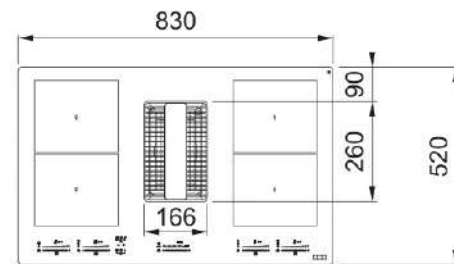
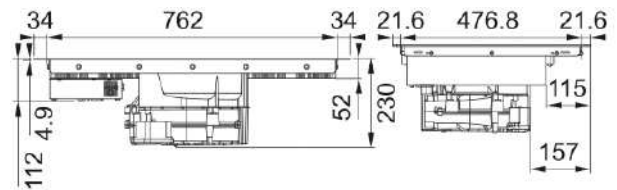

Especificaciones técnicas:

Diámetro de salida: **220 x 90 mm**
Dimensiones encastre: **ver manual de instalación**

Kit de extracción/instalación
(debes elegir siempre uno de estos modelos para su correcta instalación):



158
Kit recirculación zócalo 10cm
112.0539.570
7612985516563
434 €



159
Kit recirculación zócalo 6cm
112.0539.568
7612985516549
411 €



154
Kit extracción aspirante lateral
112.0539.569
7612985516556
121 €

Mythos

2Gether

Placa de Inducción con campana extractora



Accesorios opcionales:

141



Filtro Carbon (LL)
H100
112.0548.448
7612985546614
182 €

142



Filtro Carbon (LL)
H60
112.0548.447
7612985546607
155 €



Beneficios



Placa de inducción con extractor
FMY 839 HI 2.0



Cristal Negro
340.0597.249
7612985753333
2.999 €

Características campana:

Acabado: **Cristal negro**
Motor: **Brushless Radical Waterproof**
Mandos campana: **Slider Touch control**
Aspiración superficial
Temporizador 15 min
Velocidades: **8+2 Int (1 Int- 10 min y 2 Int. 5 min)**
Colector de líquidos: **12 cl**
Filtro de grasa: **Aluminio multicapa**
Alarma cambio filtro grasa: **Sí**
Alarma cambio filtro carbon activo: **Sí**

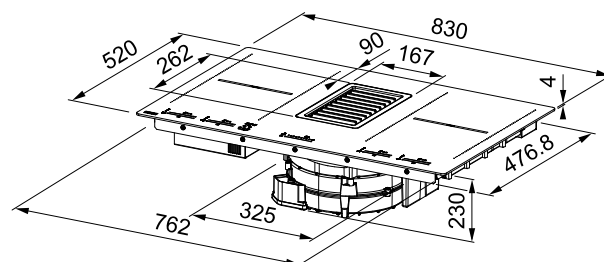

Características placa inducción:

Funciones: **Función Puento, Función Stop & Go, Calentamiento rápido**
Función Niveles de temperatura preestablecidos: **42°C fundir, 74°C mantener caliente, 92°C cocinar a fuego lento**
4 zonas de cocción:
4 zonas independientes x 184 mm x 220 mm / min Ø145 mm - máx 180 mm
2 zonas puente x 380 mm x 220 mm / min Ø110 mm - máx 245 mm
Mandos: **Touch control slider LED blanco**
Niveles de potencia: **9 + Booster**
Indicador de calor residual
Temporizador
Bloqueo de seguridad para niños
Potencia máxima: **7,545 kW**
Dimensiones (mm): **830 x 520**

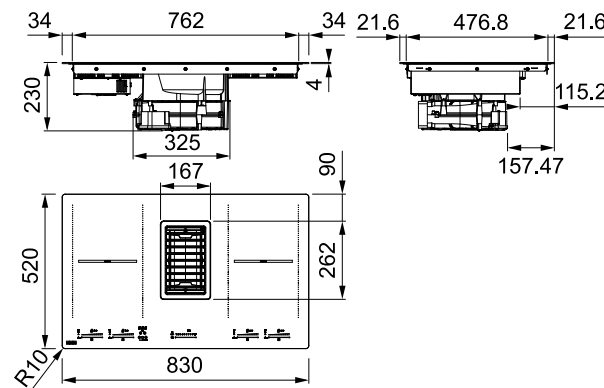

Especificaciones técnicas:

Diámetro de salida: **220 x 90 mm**
Dimensiones encastre: **ver manual de instalación**

Kit de extracción/instalación
(debes elegir siempre uno de estos modelos para su correcta instalación):



158
Kit recirculación zócalo 10cm
112.0539.570
7612985516563
434 €



159
Kit recirculación zócalo 6cm
112.0539.568
7612985516549
411 €



154
Kit extracción aspirante lateral
112.0539.569
7612985516556
121 €

Video instalación
Mythos/Maris 2gether



Maris

2Gether

Placa de Inducción con campana extractora



Accesorios opcionales:

141



Filtro Carbon (LL)
H100
112.0548.448
7612985546614
182 €

142



Filtro Carbon (LL)
H60
112.0548.447
7612985546607
155 €

220 Colección 2023



Beneficios

Placa de inducción
con extractor
FMA 839 HI

Cristal Negro
340.0595.364
7612985747400
2.099 €

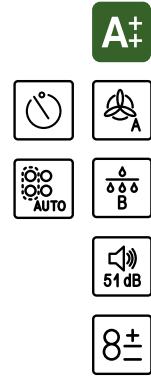
**Características campana:**

Acabado: **Cristal negro**
Motor: **Brushless Radical Waterproof**
Mandos campana: **Touch control**
Aspiración superficial
Temporizador **15 min**
Velocidades: **8+2 Int (1 Int- 10 min y 2 Int. 5 min)**
Colector de líquidos: **12 cl**
Filtro de grasa: **Aluminio multicapa**
Alarma cambio filtro grasa: **Sí**
Alarma cambio filtro carbon activo: **Sí**

Características placa inducción:

Funciones: **Función Puento, Función Stop & Go, Calentamiento rápido**
Función Niveles de temperatura preestablecidos: **42°C fundir, 74°C mantener caliente, 92°C cocinar a fuego lento**
4 zonas de cocción:
4 zonas independientes x 184 mm x 220 mm / min Ø145 mm - máx 180 mm
2 zonas puente x 380 mm x 220 mm / min Ø110 mm - máx 245 mm
Mandos: **Touch control slider LED rojo**
Niveles de potencia: **9 + Booster**
Indicador de calor residual
Temporizador
Bloqueo de seguridad para niños
Potencia máxima: **7,545 kW**
Dimensiones (mm): **830 x 520**

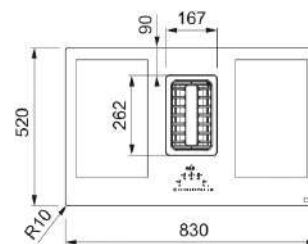
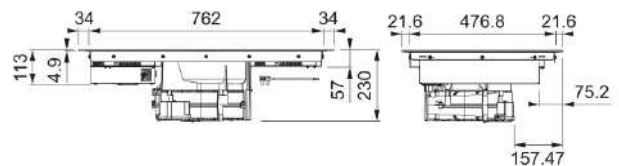
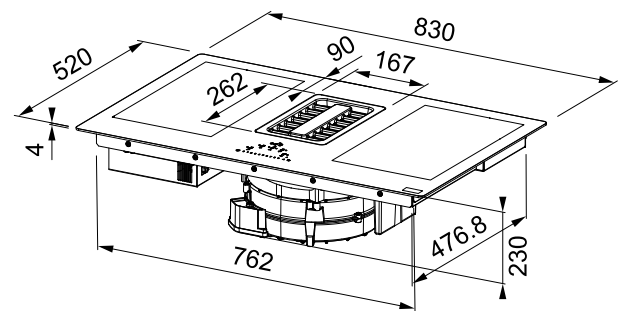
**Especificaciones técnicas:**

Diámetro de salida: **220 x 90 mm**
Dimensiones encastre: **ver manual de instalación**

Kit de extracción/instalación
(debes elegir siempre uno de estos modelos para su correcta instalación):



Kit recirculación
zócalo 10cm
112.0539.570
7612985516563
434 €

Kit recirculación
zócalo 6cm
112.0539.568
7612985516549
411 €

Kit extracción
aspirante lateral
112.0539.569
7612985516556
121 €

Video instalación
Mythos/Maris 2gether

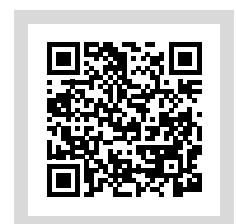

Smart 2Gether

Placa de Inducción con campana extractora



Accesorios opcionales:

141



Filtro Carbon (LL)
H100
112.0548.448
7612985546614
182 €

142



Filtro Carbon (LL)
H60
112.0548.447
7612985546607
155 €

NEW

Placa de inducción
con extractor
FSM 709 HI



Cristal Negro
340.0678.203
7612986217254
1.799 €

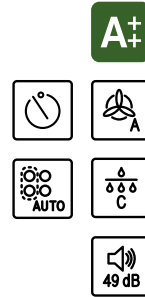
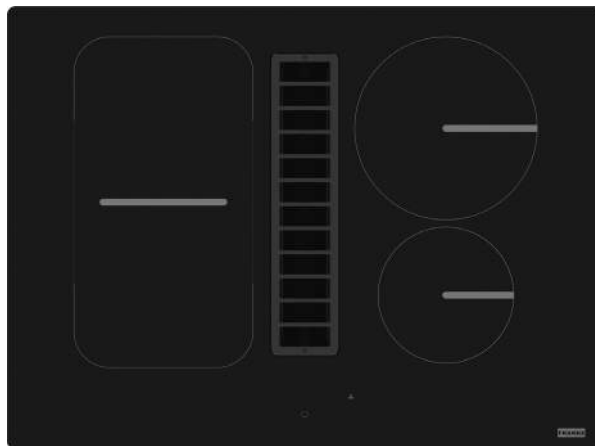

Características campana:

Acabado: **Cristal negro**
Motor: **Brushless Radical Waterproof**
Mandos campana: **Slider Touch control**
Aspiración superficial
Temporizador 15 min
Velocidades: **9+boost**
Filtro de grasa: **Aluminio multicapa**
Alarma cambio filtro grasa: **Sí**

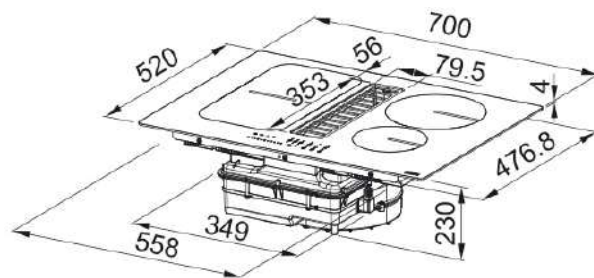

Características placa inducción:

Funciones: **Función Puente, Función Stop & Go, 74°C mantener caliente**

4 zonas de cocción:

- 2 zonas independientes x 210 x 190 mm / min Ø110 mm - máx 190 mm**
- 1 zona puente x 220 x 395 mm / min Ø190 mm - máx 230 mm**
- 1 zona independiente x R 200 mm / min Ø110 mm - máx 200 mm**
- 1 zona independiente x R 200 mm / min Ø110 mm - máx 145 mm**

Mandos: **Slim Smart KII touch slider rojo**
Niveles de potencia: **9 + Booster**
Indicador de calor residual
Temporizador
Bloqueo de seguridad para niños
Potencia máxima: **7,4 kW**
Dimensiones (mm): **700 x 520**

Especificaciones técnicas:

Diámetro de salida: **220 x 90 mm**
Dimensiones encastre: **ver manual de instalación**

Kit de extracción/instalación
(debes elegir siempre uno de estos modelos para su correcta instalación):



203
Kit recirculación
zócalo 10cm
112.0678.323
7612986217537
434 €



204
Kit recirculación
zócalo 6cm
112.0678.324
7612986217544
411 €



154
Kit extracción
aspirante lateral
112.0539.569
7612985516556
121 €

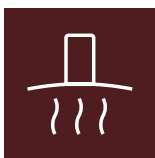

Campanas de pared

226	AQ-Sense
229	Mythos Pro
230	Maris Pro 2.0
231	Smart Wall
232	Smart Deco
234	Trendline plus
235	Crystal
236	Tale
237	Format
238	D'eco
239	Maris Dip Free
240	AQ-Sense
242	Maris Plus 2.0
243	Maris 2.0
244	Neo
245	Evo Plus



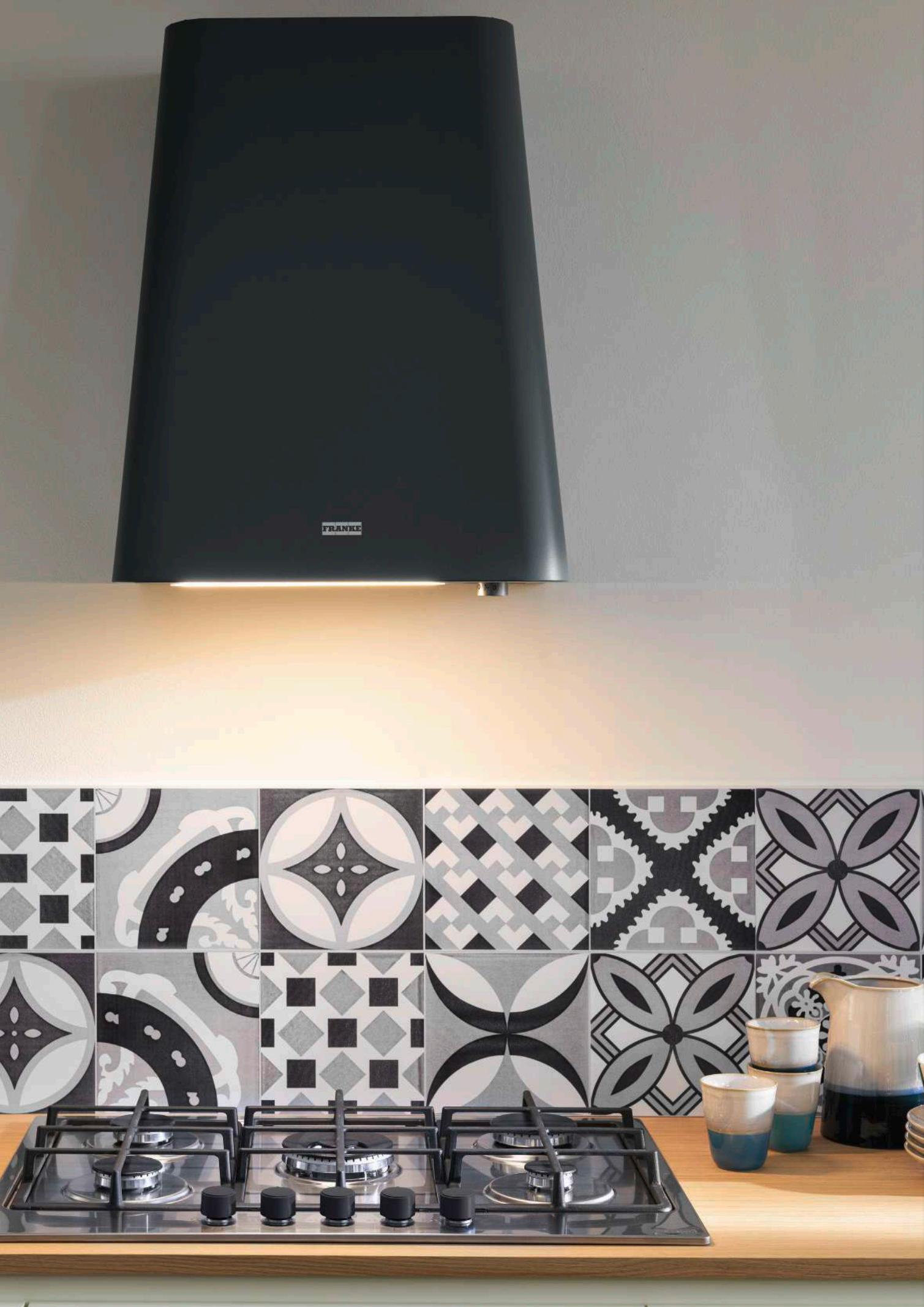

Cubetas

Fregaderos

Girfos

Campanas

Electrodomésticos

Gestión de residuos

Accesorios

Campanas AQ Sense

La campana que todo hogar se merece



Mantén limpio el aire que respiras

Toda la gama de campanas AQ SENSE cuentan con la función de sensor de calidad del aire, analiza continuamente la calidad del aire del interior de la cocina (COV*), la temperatura y la humedad mientras mantiene informado al usuario a través de la aplicación Franke @ Home. La misma aplicación permite controlar otras funciones de la campana por medio del móvil o Tablet: encender y apagar, ajusta el nivel de aspiración o adecuar la intensidad de la luz.

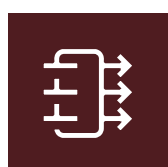

Sensor de calidad el aire

Controla continuamente la calidad del aire del interior de la cocina (COV*) y mantiene informado al usuario a través de la aplicación. Además, te informa de la temperatura y la humedad.



Conexión internet

Disfruta de una pantalla táctil con conexión a internet.



Función Auto

Ahorra energía: El nivel de aspiración se configura automáticamente hasta que la calidad del aire alcance el nivel adecuado.



Temporizador*

Permite controlar el tiempo.



Compatible con control por voz**

¡Controla tu campana con tu voz! Perfecto para cuando tus manos están ocupadas cocinando tus platos favoritos.



Tus fotos*

Disfruta recordando los momentos con la familia en la pantalla. Puedes personalizar el fondo de pantalla de tu campana.



Panel de control táctil

Además de mantenerte informado acerca de la calidad del aire, también te permite controlar la campana por medio de la pantalla.

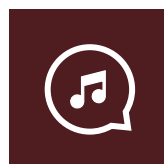

Buscador incluido*

Navega en la web para encontrar las mejores recetas, escucha tu música favorita, lee noticias, tienes acceso a un mundo de contenido en línea.



Luz regulable*

Ajusta la intensidad de la luz para crear el ambiente perfecto.

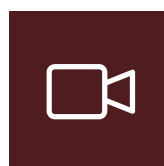

Camara

Conecta tu camara al Wifi y mantén todo bajo control.

* Exclusivo para la gama AQ FKAS A80 BK

**Control de voz no incluido

AQ-Sense

Campana Vertical



MYTHOS



FKAS A80 BK
Cristal Negro
330.0657.269
7612986090307
4.503 €

Clase energética: **A+**
Ancho: **800 mm**
Mandos: **Panel de control táctil, Mando a distancia opcional**
Aspiración (mín-máx-int): **280-580-740**
Presión (Pa) (mín-máx-int): **450-550-560**
P. Sonora (dBA) (mín-máx-int): **48-62-67**
Potencia (W) (mín-máx-int): **150-240-250**
Iluminación: **LED 2 x 1W / 3000 K**

AQ-SENSE
FKAS A80



Accesorio incluido

132



Set de dos filtros de carbón activo
112.0152.193
42 €

Accesorios opcionales

146



Set de dos filtros de carbón activo larga duración
112.0492.115
77 €

128



Set de dos filtros de carbón activo high performance
112.0174.995
95 €

127



Control remoto
112.0657.298
63 €

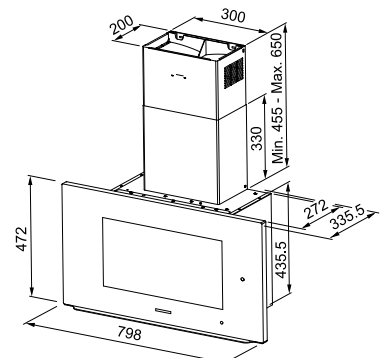

228 Colección 2023

Mythos Pro

Campana Vertical



MYTHOS



NEW

MYTHOS PRO
FMY PRO 907



 FMY PRO 907 FM BK/BK MATT
Negro Mate
330.0682.353
7612986233476
1.099 €

 FMY PRO 907 FM BK/IX
Negro Mate / Acero Inox
330.0682.352
7612986233469
1.049 €

Clase energética: **A++**
Ancho: **900 mm**
Mandos: **Táctiles**
Aspiración (mín-máx-int):
230-450-880
Presión (Pa) (mín-máx-int):
450-500-630
P. Sonora (dBA) (mín-máx-int):
41-49-56
Potencia (W) (mín-máx-int):
8-30-170
Iluminación: **LED Bar Slim**
Filtro: **Acero Inox**

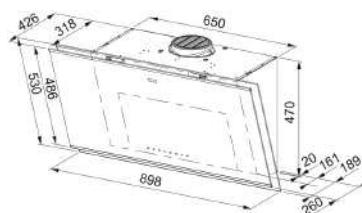

Accesorios opcionales

197



Kit chimenea ext H50-
990mm negra
112.0683.833
89 €

196



Kit chimenea ext H50-
500mm negra
112.0683.832
109 €

128



Set de dos filtros de
carbón activo high
performance
112.0174.995
95 €

Maris Pro 2.0

Campana Vertical



MARIS



NEW

MARIS PRO 2.0
FMA 907



FMA 907 BK/BK MATT
Cristal Negro
330.0682.355
7612986233490
949 €

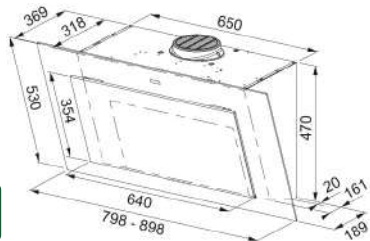

Clase energética: **A+**
Ancho: **900 mm**
Mandos: **Táctiles**
Aspiración (mín-máx-int):
270-450-790
Presión (Pa) (mín-máx-int):
450-560-600
P. Sonora (dBA) (mín-máx-int):
46-56-68
Potencia (W) (mín-máx-int):
160-240-270
Iluminación: **LED 2 x 4000K**
Filtro: **Acero Inox**

Accesorios opcionales



197

Kit chimenea ext H50-
990mm negra
112.0683.833
89 €



196

Kit chimenea ext H50-
500mm negra
112.0683.832
109 €



128

Set de dos filtros de
carbón activo high
performance
112.0174.995
95 €

230 Colección 2023

Smart Wall

Campana de pared



SMART



FSMS WALL F 42 BK MATT
Negro Mate
335.0689.671
7612986272475
899 €

FSMS WALL F 42 WH MATT
Blanco Mate
335.0689.672
7612986272482
899 €

Clase energética: **A**
Ancho: **420 mm**
Mandos: **Push-Button**
Aspiración (mín-máx-int):
270-580-740
Presión (Pa) (mín-máx-int):
450-570-580
P. Sonora (dBA) (mín-máx-int):
53-66-70
Potencia (W) (mín-máx-int):
150-240-250
Iluminación: **LED 2x 3000K**
Filtro: **Aluminio**

SMART WALL
FSMS WALL F 42

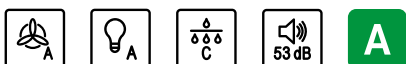

Accesorios incluidos



128
Set de dos filtros de
carbón activo high
performance
112.0174.995
95 €

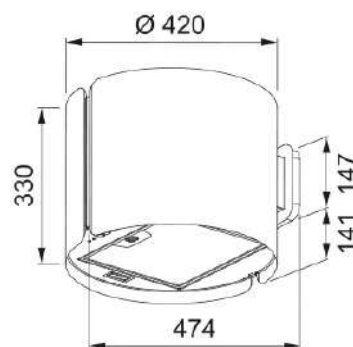

Smart

Deco

Campana de pared



Accesorio incluido

132



Set de dos filtros de
carbón activo
112.0152.193
42 €

Accesorios opcionales

146



Set de dos filtros de
carbón activo larga
duración
112.0492.115
77 €

128



Set de dos filtros de
carbón activo high
performance
112.0174.995
95 €

169



Chimenea redonda
Smart Deco
112.0549.122
260 €

232 Colección 2023

SMART

SMART DECO
FSMD 508

- FSMD 508 BK
Negro
RAL NCS S 9000-N
335.0528.006
7612985469883
807 €
- FSMD 508 BL
Azul
RAL NCS S 3020-B
335.0530.203
7612985478298
807 €
- FSMD 508 GN
Verde
RAL NCS S 5010-G10Y
335.0530.200
7612985478267
807 €
- FSMD 508 GY
Gris claro
RAL NCS S 2000-N
335.0530.199
7612985478250
807 €
- FSMD 508 RS
Rosa
RAL NCS S 1515-Y80R
335.0530.201
7612985478274
807 €
- FSMD 508 WH
Blanco
RAL NCS S 0502-Y50R
335.0528.005
7612985469876
807 €
- FSMD 508 YL
Mostaza
RAL NCS S 2050-Y20R
335.0530.202
761298548281
807 €

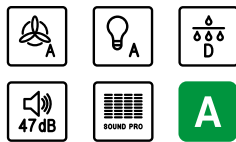

Clase energética: **A**
 Ancho: **500mm**
 Mandos: **Rotativo push**
 Aspiración (mín-máx-int):
270-370-630
 Presión (Pa) (mín-máx-int):
410-490-560
 P. Sonora (dBA) (mín-máx-int):
47-54-65
 Potencia (W) (mín-máx-int):
150-200-250
 Iluminación: **Barra LED 1 x 3 W / 3000 K**
 Filtro: **Carbón activo**

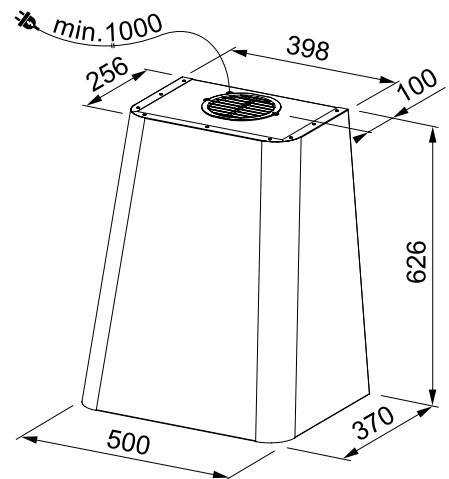

Cubetas

Fregaderos

Grifos

Campanas

Electrodomésticos

Gestión de residuos

Accesorios

Trendline plus

Campana de pared



SMART



TRENDLINE PLUS BK
Negro Mate

321.0536.200
7612985505390
1.038 €

TRENDLINE PLUS OY
Oyster

321.0536.201
7612985505901
1.038 €

Clase energética: **B**
Ancho: **700 mm**

Mandos: **Rotativos Push-Pull**

Aspiración (mín-máx-int):

280-420-600

Presión (Pa) (mín-máx-int):

450-540-580

P. Sonora (dBA) (mín-máx-int):

45-52-62

Potencia (W) (mín-máx-int):

150-200-250

Iluminación: **LED 2 x 1 W**

TRENDLINE PLUS



Accesorios opcionales

132



Set de dos filtros de carbón activo
112.0152.193
42 €

146



Set de dos filtros de carbón activo larga duración
112.0492.115
77 €

128



Set de dos filtros de carbón activo high performance
112.0174.995
95 €

234 Colección 2023

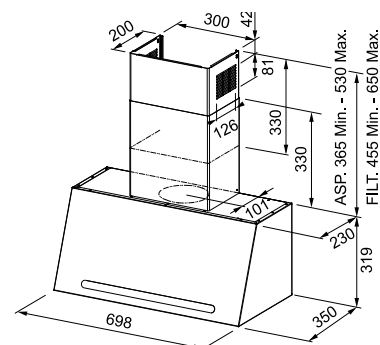

Crystal

Campana T Invertida

Cubetas

Fregaderos

Grifos

Campanas

Electrodomésticos

Gestión de residuos

Accesorios



MARIS



FCR 925 TC BK/XS NG
Acero Inox / Perfil Negro
325.0654.002
7612986055887
599 €

Clase energética: **A+**
Ancho: **900 mm**
Mandos: **Mandos táctiles**
Aspiración (mín-máx-int):
280-600-750
Presión (Pa) (mín-máx-int):
450-580-590
P. Sonora (dBA) (mín-máx-int):
50-65-69
Potencia (W) (mín-máx-int):
150-240-250
Iluminación: **LED 2 x 1 W / 3000 K**
Filtro: **Carbón Activo Incluidos**

CRYSTAL
FCR 925 TC



Accesorio incluido

134



Filtro de carbón activo
112.0151.250
30 €

Accesorio opcional

145



Filtro de carbón activo
larga duración
112.0492.116
77 €

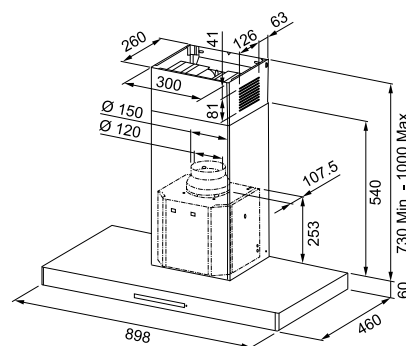

Colección 2023 **235**

Tale

Campana T Invertida



MARIS



Clase energética: **A++**
 Ancho: **600-800-900-1200 mm**
 Mandos: **Panel de control electrónico retroiluminado**
 Aspiración (mín-máx-int):
270-450-780
 Presión (Pa) (mín-máx-int):
460-560-590
 P. Sonora (dBA) (mín-máx-int):
48-60-71
 Potencia (W) (mín-máx-int):
165-240-270
 Iluminación: **LED 2 x 1W / 4000 K**

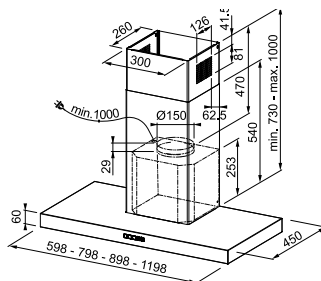

120 cm

Tale 1215 XS
Inox
325.0597.295
 7612985753449
680 €

90 cm

Tale 915 W BK MATT
Negro Mate
325.0657.512
 7612986090093
646 €

Tale 915 XS
Inox
325.0597.294
 7612985753432
600 €

80 cm

Tale 815 XS
Inox
325.0597.296
 7612985753456
576 €

60 cm

Tale 615 XS
Inox
325.0597.293
 7612985753425
542 €

TALE



Accesorios opcionales



134
 Filtro de carbón activo
112.0151.250
30 €



145
 Filtro de carbón activo
 larga duración
112.0492.116
77 €



137
 Filtro de carbón activo High
 performance metal lavable
112.0373.738
91 €

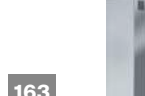

163
 Prolongación canal pared
 300 x 990 x 260 mm
112.0017.983
110 €

Format

Campana T Invertida

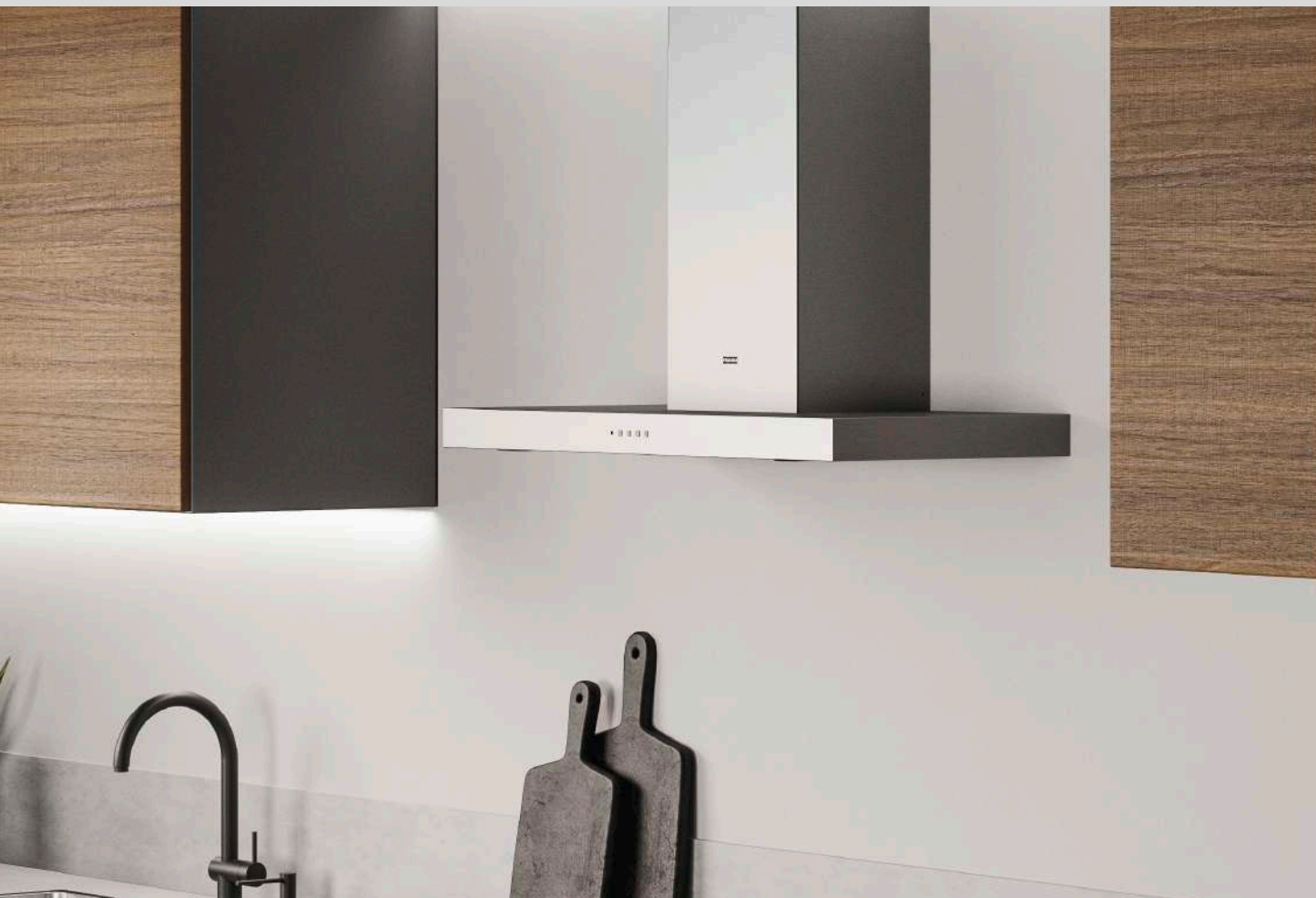

SMART



FORMAT
FDF EV8



Clase energética: **B**
 Ancho: **600-700-900 mm**
 Mandos: **Electrónicos**
 Aspiración (mín-máx-int):
290-610-710
 Presión (Pa) (mín-máx-int):
390-530-540
 P. Sonora (dBA) (mín-máx-int):
50-66-69
 Potencia (W) (mín-máx-int):
130-210-250
 Iluminación: **LED 2 x 1 W / 4000 K**

90 cm

 FDF EV8 90 BK
Negro Mate
325.0599.574
 7612985765046
519 €

 FDF EV8 90 XS
Inox
325.0599.549
 7612985765015
507 €

70 cm

 FDF EV8 70 XS
Inox
325.0599.576
 7612985765060
461 €

60 cm

 FDF EV8 60 XS
Inox
325.0599.575
 7612985765053
426 €

Accesorios

134



Filtro de carbón activo
112.0151.250
30 €

145



Filtro de carbón activo
 larga duración
112.0492.116
77 €

137



Filtro de carbón activo High
 performance metal lavable
112.0373.738
91 €

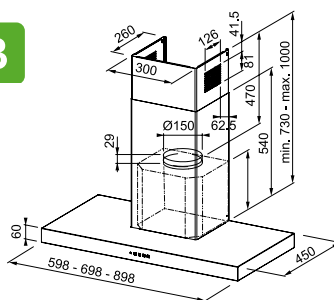

D'eco

Campana Piramidal



SMART



90 cm

FDL 9165 XS
Acero Inox
320.0528.016
7612985469982
272 €

60 cm

FDL 6165 XS
Acero Inox
320.0528.015
7612985469975
226 €

Clase energética: **B**

Ancho: **600-900 mm**

Mandos: **Electrónicos**

Aspiración (mín-máx-int):

310-620-740

Presión (Pa) (mín-máx-int):

390-500-530

P. Sonora (dBA) (mín-máx-int):

49-64-67

Potencia (W) (mín-máx-int):

130-210-250

Iluminación: **LED 2 x 4 W / 4000 K**

D'ECO
FDL



Accesorios opcionales

132



Set de dos filtros de
carbón activo
112.0152.193
42 €

146



Set de dos filtros de
carbón activo larga
duración
112.0492.115
77 €

128



Set de dos filtros de
carbón activo high
performance
112.0174.995
95 €

238 Colección 2023

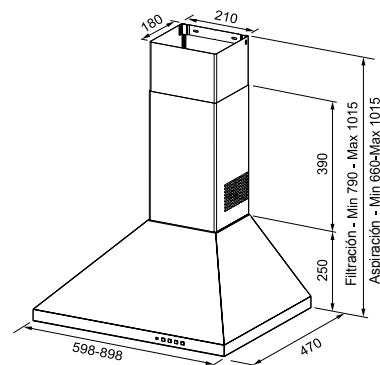

Maris Drip Free

Campana Inclinada anticondensación



MARIS



MARID DRIP
FVAD A90



FVAD A90 BK MATT
Negro Mate
330.0657.418
7612986090079
923 €

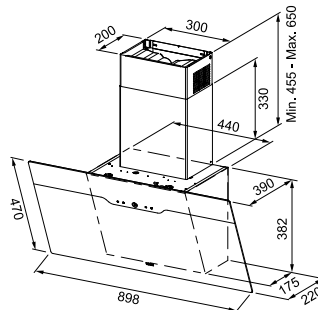

Función anticondensación

Clase energética: **A**

Ancho: **900 mm**

Mandos: **Mandos táctiles**

Aspiración (mín-máx-int):

290-600-740

Presión (Pa) (mín-máx-int):

450-560-580

P. Sonora (dBA) (mín-máx-int):

48-63-68

Potencia (W) (mín-máx-int):

150-240-250

Iluminación: **LED 2 x 1W / 3000 K**

Filtro: **Carbón Activo Incluidos**

Accesorio incluido

132



Set de dos filtros de carbón activo
112.0152.193
42 €

Accesorio opcional

146



Set de dos filtros de carbón activo larga duración
112.0492.115
77 €

128



Set de dos filtros de carbón activo high performance
112.0174.995
95 €

152



Kit chimenea (2 uds) canal negro
500 x 300 x 200 mm
112.0285.288
99 €

153



Kit chimenea (2 uds) inox
500 x 300 x 200 mm
112.0197.447
85 €

164



Chimenea inox
990 x 300 x 200 mm
112.0036.204
85 €

Colección 2023 **239**

Cubetas

Fregaderos

Girifos

Campanas

Electrodomésticos

Gestión de residuos

Accesorios

AQ-Sense

Campana Inclinada



Accesorios opcionales

132



Set de dos filtros de
carbón activo
112.0152.193
42 €

146



Set de dos filtros de
carbón activo larga
duración
112.0492.115
77 €

128



Set de dos filtros de
carbón activo high
performance
112.0174.995
95 €

127



Control remoto
112.0657.298
63 €

240 Colección 2023



AQ-SENSE
FVAS A80



FVAS A80 BK
Negro
330.0657.270
7612986090314
958 €

Clase energética: **A+**
Ancho: **800 mm**
Control: **App FRANKE@HOME/Alexa,**
Posibilidad de control a distancia
Aspiración (mín-máx-int):
300-620-770
Presión (Pa) (mín-máx-int):
460-590-600
P. Sonora (dBA) (mín-máx-int):
48-63-68
Potencia (W) (mín-máx-int):
150-240-250
Iluminación: **LED 2 x 1W / 3000 K**

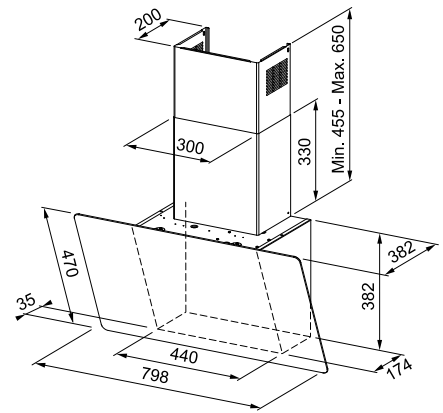

Maris 2.0

Campana Inclinada



Accesorio incluido

132



Set de dos filtros de
carbón activo
112.0152.193
42 €

Accesorio opcional

146



Set de dos filtros de
carbón activo larga
duración
112.0492.115
77 €

128



Set de dos filtros de
carbón activo high
performance
112.0174.995
95 €

197



Kit chimenea ext H50-
990mm negra
112.0683.833
89 €

196



Kit chimenea ext H50-
500mm negra
112.0683.832
109 €

242 Colección 2023



MARIS
FMA PRO



90 cm



FMA PRO 907 BK
Negro
330.0682.357
7612986233810
899 €

80 cm



FMA PRO 807 BK
Negro
330.0682.358
7612986233827
869 €

Clase energética: **A+**

Ancho: **900-800 mm**

Mandos: **Táctiles**

Aspiración (mín-máx-int):

270-450-790

Presión (Pa) (mín-máx-int):

450-560-600

P. Sonora (dBA) (mín-máx-int): **46-56-68**

Potencia (W) (mín-máx-int):

160-240-270

Iluminación: **LED 2 x 4000K**

Filtro: **Acero Inox**

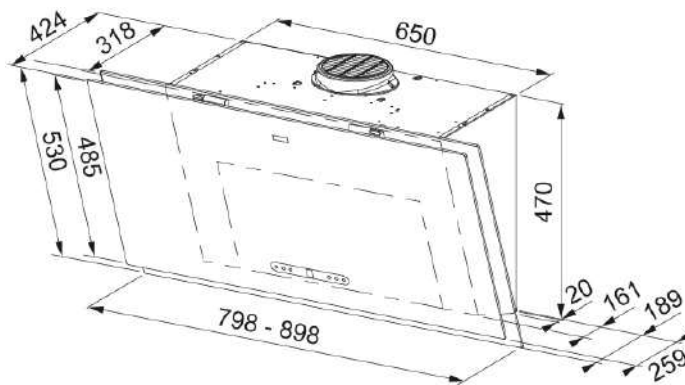

Neo

Campana Inclinada



MARIS



90 cm



FNO 905 BK
Negro
330.0591.773
7612985733366
865 €

80 cm



FNO 805 BK
Negro
330.0591.775
7612985733373
842 €

60 cm



FNO 605 BK
Negro
330.0591.778
7612985733380
819 €

Clase energética: **A+**

Ancho: **600-800-900 mm**

Mandos: **Táctiles**

Aspiración (mín-máx-int):

280-470-800

Presión (Pa) (mín-máx-int):

150-560-600

P. Sonora (dBA) (mín-máx-int):

48-57-69

Potencia (W) (mín-máx-int):

160-230-270

Iluminación: **LED 2 x 1W / 4000 K**

Filtro: **Carbón Activo Incluidos**

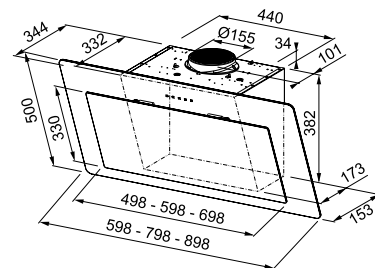

NEO
FNO



Accesorio incluido

132



Set de dos filtros de
carbón activo
112.0152.193
42 €

Accesorio opcional

146



Set de dos filtros de
carbón activo larga
duración
112.0492.115
77 €

128



Set de dos filtros de
carbón activo high
performance
112.0174.995
95 €

152



Kit chimenea (2 uds)
canal negro
500 x 300 x 200 mm
112.0285.288
99 €

153



Kit chimenea (2 uds) inox
500 x 300 x 200 mm
112.0197.447
85 €

164



Chimenea inox
990 x 300 x 200 mm
112.0036.204
85 €

244 Colección 2023

Evo Plus

Campana Inclinada



SMART



EVO PLUS
FPJ



Accesorio incluido

132



Set de dos filtros de
carbón activo
112.0152.193
42 €

Accesorios opcionales

146



Set de dos filtros de
carbón activo larga
duración
112.0492.115
77 €

128



Set de dos filtros de
carbón activo high
performance
112.0174.995
95 €

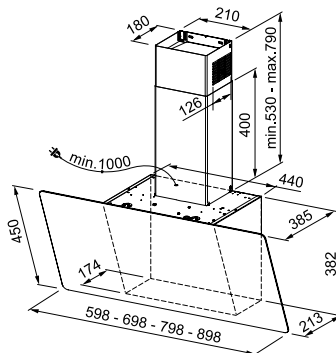

Clase energética: **A+**
Ancho: **600-700-800-900 mm**
Mandos: **Táctiles**
Aspiración (mín-máx-int):
300-620-770
Presión (Pa) (mín-máx-int):
460-590-600
P. Sonora (dBA) (mín-máx-int):
48-63-68
Potencia (W) (mín-máx-int):
150-240-250
Iluminación: **LED 2 x 1 W / 4000 K**
Filtro: **Carbón Activo Incluidos**

90 cm

FPJ 925 V WH/SS
Cristal Blanco
330.0528.020
7612985470025
611 €

FPJ 925 V BK/SS
Cristal Negro
330.0528.067
7612985470070
611 €

80 cm

FPJ 825 V WH/SS
Cristal Blanco
330.0584.865
7612985705462
576 €

FPJ 825 V BK/SS
Cristal Negro
330.0584.864
7612985705455
576 €

70 cm

FPJ 705 V WH/SS
Cristal Blanco
330.0528.061
7612985470032
553 €

FPJ 705 V BK/SS
Cristal Negro
330.0528.069
7612985470087
553 €

60 cm

FPJ 625 V WH/SS
Cristal Blanco
330.0528.065
7612985470063
542 €

FPJ 625 V BK/SS
Cristal Negro
330.0528.064
7612985470056
542 €

Colección 2023 **245**

Cubetas

Fregaderos

Grifos

Campanas

Electrodomésticos

Gestión de residuos

Accesorios

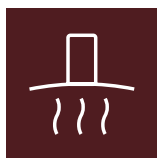

Campanas Integradas

248	AQ-Sense
249	Atmos
250	Style Drip-Free
253	Style Pro
254	Style Plus
255	Smart Style
256	Box plus 2.0
257	Box Plus Flush 2.0
258	Grupo filtrante
259	Smart FSM
259	FTC 601-912
259	Smart FTC





Cubetas

Fregaderos

Girfos

Campanas

Electrodomésticos

Gestión de residuos

Accesorios

AQ-Sense

Campana Integración



MYTHOS



120 cm

FSAS A120 BK/XS
Inox
305.0657.262
7612986089943
1.038 €

90 cm

FSAS A90 BK/XS
Inox
305.0657.263
7612986089950
923 €

Clase energética: **A**
Ancho: **900-1200 mm**
Control: **App FRANKE@HOME/ Alexa, Control a distancia (mando a distancia opcional)**
Aspiración (mín-máx-int): **250-570-670**
Presión (Pa) (mín-máx-int): **450-570-580**
P. Sonora (dBA) (mín-máx-int): **53-67-69**
Potencia (W) (mín-máx-int): **150-240-250**
Iluminación: **LED 2 x 3 W / 3000 K**

AQ-SENSE
FSAS A



Accesorio incluido

134



Filtro de carbón activo
112.0151.250
30 €

Accesorios opcionales

145



Filtro de carbón activo
larga duración
112.0492.116
77 €

127



Control remoto
112.0657.298
63 €

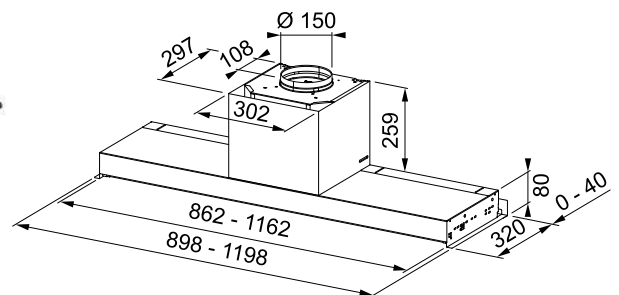



Beneficios

Atmos

Campana Integración anticondensación



MYTHOS



ATMOS
FSO 904



Accesorio opcional



129

Set de 2 filtros carbón
112.0542.064
54 €

FSO 904 BI AC
Inox
305.0504.066
7612985144148
1.281 €

Función anticondensación

Clase energética: **A**

Ancho: **900 mm**

Mandos: **Touch control**

Aspiración (mín-máx-int):

140-320-430

Presión (Pa) (mín-máx-int):

230-270-290

P. Sonora (dBA) (mín-máx-int):

52-66-70

Potencia (W) (mín-máx-int):

80-120-/-

Iluminación: **LED 2 x 1,3 W**

Filtro: **de grasa Acero inox**

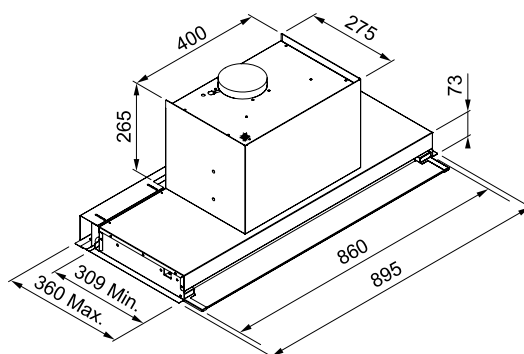

Colección 2023 **249**

Cubetas

Fregaderos

Grifos

Campanas

Electrodomésticos

Gestión de residuos

Accesorios

Cubetas

Fregaderos

Grifos

Campanas

Electrodomésticos

Gestión de residuos

Accesorios

Style Drip-Free

Adiós a la condensación, adiós al drama



Haz que la molesta condensación sea un recuerdo del pasado con la nueva campana Style Drip-Free y redescubre el placer de cocinar. Especialmente diseñada para resolver el problema de la condensación y las gotas que caen sobre la placa de cocción, la campana anticondensación Style Drip-Free es la solución ideal para cualquier placa de inducción. Su mayor superficie de aspiración, el filtro especial inclinado y el excelente flujo de aire capturan la máxima cantidad de vapores y humos en la cocina. Los vapores quedan atrapados y puedes cocinar con total libertad.



Mayor superficie de aspiración

Gracias a la combinación entre una mayor superficie de aspiración y una excelente circulación del aire, la campana se ocupa fácilmente de los goteos y la condensación sin necesidad de una resistencia eléctrica



Fácil acceso al desagüe

Gracias a su intuitivo mecanismo bandeja de recogida se puede retirar con una sola mano

Adiós a la grasa

Cuando necesites limpiar el filtro, simplemente colocalo en el lavavajillas. Ahorras tiempo y esfuerzo.



Visera de cristal extensible

Sutil y ligera, la visera de cristal de la campana se prolonga hacia el exterior para que los bordes de los armarios estén protegidos de la humedad y la condensación.

Control por mando a distancia

El mando a distancia opcional hace que controlar todas las funciones de la campana Style Drip Free sea más fácil

Style Drip-Free

Campana Integración anticondensación



MARIS



Función anticondensación
Clase energética: **A**
Ancho: **600-900-1200 mm**
Mandos: **Touch control en el cristal. Control a distancia opcional**

Aspiración (mín-máx-int):
280-580-710

Presión (Pa) (mín-máx-int):
450-550-560

P. Sonora (dBA) (mín-máx-int):
49-65-69

Potencia (W) (mín-máx-int):
150-240-250

Iluminación: **LED 2 x 1W / 4000 K**
Filtro: **de grasa lavables en lavavajillas**

120 cm

FST 120 X
Inox
305.0662.834
7612986118919
1.015 €

90 cm

FST 90 X
Inox
305.0662.835
7612986118926
923 €

60 cm

FST 60 X
Inox
305.0662.836
7612986118933
807 €

STYLE DRIP-FREE
FST



Accesorios opcionales

131
Filtro carbón rectangular
267x237
112.0670.624
45 €

127
Control remoto
112.0657.298
63 €

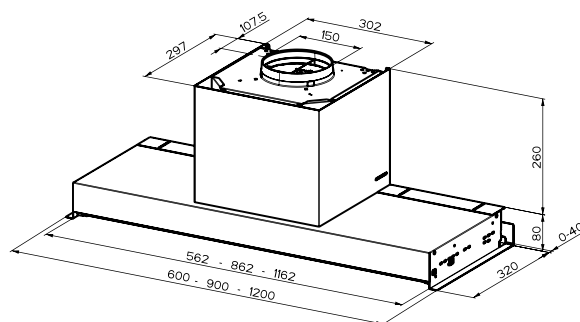

252 Colección 2023

Style Pro

Campana Integración



MARIS



Clase energética: **A**
 Ancho: **600-900-1200 mm**
 Mandos: **Mando rotativo**
 Aspiración (mín-mid-máx):
260-360-640
 Presión (Pa) (mín-mid-máx):
420-510-580
 P. Sonora (dBA) (mín-mid-máx):
49-56-67
 Potencia (W) (mín-máx-int):
150-200-250
 Iluminación: **LED 2 x 1 W / 4000 K**

120 cm

FSTPRO 1208
Inox
305.0522.799
 7612985450720
715 €

90 cm

FSTPRO 908 X
Inox
305.0522.797
 7612985450706
646 €

60 cm

FSTPRO 608 X
Inox
305.0522.798
 7612985450713
623 €

STYLE PRO
 FSTPRO

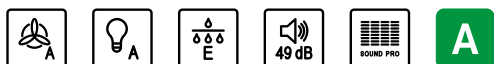

Accesorios

148

 Set 2 filtros carbón
 activo larga duración
112.0473.657
55 €

130

 Set 2 filtros carbón
 activo estándar
112.0493.319
54 €

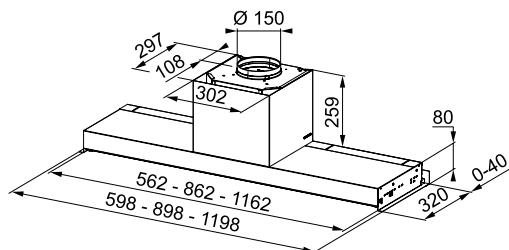

Colección 2023 **253**

Cubetas

Fregaderos

Grifos

Campanas

Electrodomésticos

Gestión de residuos

Accesorios

Style Plus

Campana Integración



MARIS



STYLE PLUS
FST PLUS



Accesorios opcionales

148



Set 2 filtros carbón
activo larga duración
112.0473.657
55 €

130



Set 2 filtros carbón
activo estándar
112.0493.319
54 €

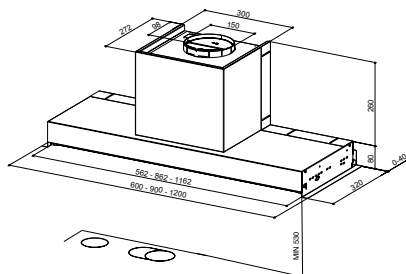

Clase energética: **A**
Ancho: **600-900-1200 mm**
Mandos: **Mando rotativo**
Aspiración (mín-mid-máx):
260-360-650
Presión (Pa) (mín-mid-máx):
450-520-560
P. Sonora (dBA) (mín-mid-máx):
50-57-69
Potencia (W) (mín-máx-int):
250-200-250
Iluminación: **LED 2 x 1 W / 4000 K**

120 cm

FST PLUS 1208 X
Inox
305.0572.836
7612985663182
669 €

90 cm

FST PLUS 908 X
Inox
305.0572.834
7612985663168
623 €

60 cm

FST PLUS 608 X
Inox
305.0572.835
7612985663175
588 €

Smart Style

Campana Integración



SMART



Clase energética: **C**
 Ancho: **600-900-1200 mm**
 Mandos: **Mandos giratorios**
 Aspiración (mín-mid-máx):
250-380-570
 Presión (Pa) (mín-mid-máx):
230-370-500
 P. Sonora (dBA) (mín-mid-máx):
47-56-65
 Potencia (W) (mín-máx-int):
80-105-160
 Iluminación: **LED 2 x 1 W**
 Filtro de grasa: **Acero Inoxidable**

120 cm

FSTP NG 1205 X
Inox
110.0473.547
 7612981833213
600 €

90 cm

FSTP NG 905 X
Inox
110.0473.546
 7612981832605
576 €

60 cm

FSTP NG 605 X
Inox
110.0473.545
 7612981832599
530 €

SMART STYLE
 FSTP NG



Accesorios opcionales

148



Set 2 filtros carbón
 activo larga duración
112.0473.657
55 €

130



Set 2 filtros carbón
 activo estándar
112.0493.319
54 €

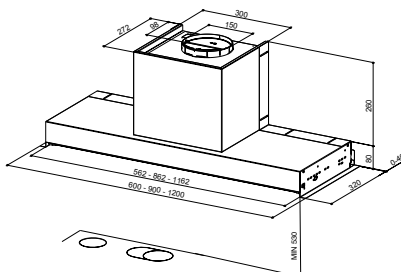

Box plus 2.0

Grupo Filtrante



MARIS

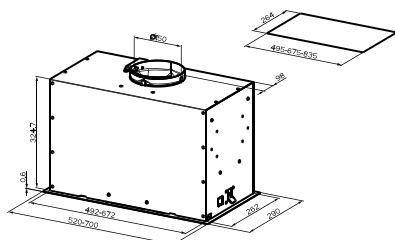

BOX PLUS FBFE A70



FBFE BK MATT A70
Negro Mate
305.0665.365
7612986152999
542 €



FBFE WH MATT A70
Blanco Mate
305.0665.367
7612986153019
542 €

Clase energética: **B**

Ancho: **700 mm**

Mandos: **Panel de control electrónico**

Aspiración (mín-máx-int):

280-570-670

Presión (Pa) (mín-máx-int):

390-530-540

P. Sonora (dBA) (mín-máx-int):

47-63-66

Potencia (W) (mín-máx-int):

130-210-250

Iluminación: **Led Bar Slim 3000K**

Filtro: **de grasa Aluminio**



BOX PLUS FBFE A52



FBFE BK MATT A52
Negro Mate
305.0665.364
7612986152982
519 €



FBFE WH MATT A52
Blanco Mate
305.0665.366
7612986153002
519 €

Clase energética: **B**

Ancho: **520 mm**

Mandos: **Panel de control electrónico**

Aspiración (mín-máx-int):

280-540-620

Presión (Pa) (mín-máx-int):

390-530-540

P. Sonora (dBA) (mín-máx-int):

47-64-67

Potencia (W) (mín-máx-int):

130-210-240

Iluminación: **Led Bar Slim 3000K**

Filtro: **de grasa Aluminio**



Accesorios opcionales

132



Set de dos filtros de carbón activo
112.0152.193
42 €

146



Set de dos filtros de carbón activo larga duración
112.0492.115
77 €

128



Set de dos filtros de carbón activo high performance
112.0174.995
95 €

256 Colección 2023

Box Plus Flush 2.0

Grupo Filtrante



MARIS



BOX PLUS FLUSH 2.0 FBFE A70

FBFE XS A70
Inox
305.0665.361
7612986152975
519 €

Clase energética: **B**
Ancho: **700 mm**
Mandos: **Panel de control electrónico**
Aspiración (mín-máx-int):
280-570-670
Presión (Pa) (mín-máx-int):
390-530-540
P. Sonora (dBA) (mín-máx-int):
47-63-66
Potencia (W) (mín-máx-int):
130-210-250
Iluminación: **Led 3000K**



BOX PLUS FLUSH 2.0 FBFE A52

FBFE XS A52
Inox
305.0665.359
7612986152968
484 €

Clase energética: **B**
Ancho: **520 mm**
Mandos: **Panel de control electrónico**
Aspiración (mín-máx-int):
280-540-620
Presión (Pa) (mín-máx-int):
390-530-540
P. Sonora (dBA) (mín-máx-int):
47-64-67
Potencia (W) (mín-máx-int):
130-210-240
Iluminación: **Led 3000K**

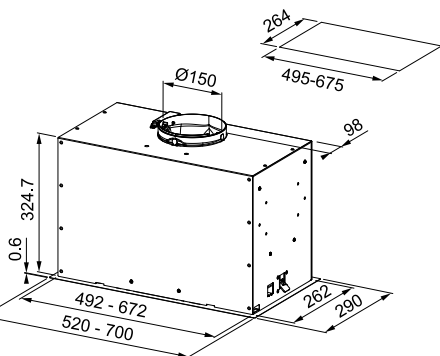

Accesorios opcionales



132
Set de dos filtros de
carbón activo
112.0152.193
42 €



146
Set de dos filtros de
carbón activo larga
duración
112.0492.115
77 €



128
Set de dos filtros de
carbón activo high
performance
112.0174.995
95 €

Grupo filtrante

Grupo Filtrante



SMART



FBI



Accesorio opcional

136



Set 2 filtros
carbón redondos
112.0564.564
18 €

258 Colección 2023

Clase energética: **B**
Ancho: **700-520 mm**
Mandos: **Mandos deslizantes**
Aspiración (mín-máx-int):
180-270-390
Presión (Pa) (mín-mid-máx):
220-240-260
P. Sonora (dBA) (mín-mid-máx):
54-62-70
Potencia (W) (mín-mid-máx):
80-90-110
Iluminación: **Led 2 x 4W**
Filtro: **de grasa Aluminio**

70 cm

FBI 705 XS
Inox
305.0599.508
7612985764742
253 €

52 cm

FBI 525 XS
Inox
305.0599.507
7612985764735
230 €

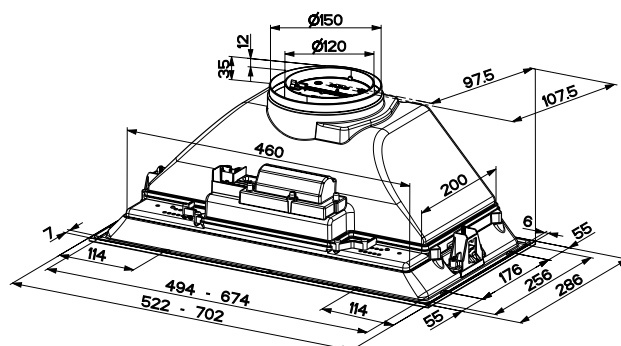

SMART

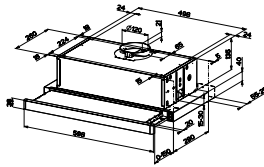
SMART FSM
FSM 601

FSM 601 BK/GL
Negro
315.0489.958
7612981899790
295 €

FSM 601 WH/GL
Blanco
315.0489.957
7612981899783
295 €



Clase energética: **D**
Ancho: **600 mm**
Mandos: **Mandos mecánicos**
Aspiración (mín-mid-máx):
225-315-380
Presión (Pa) (mín-mid-máx):
200-220-240
P. Sonora (dBA) (mín-mid-máx):
58-67-69
Potencia (W) (mín-mid-máx):
85-100-140
Iluminación: **LED 2 x 1W / 3000K**

135

SMART

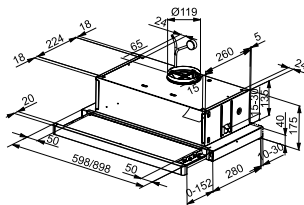
FTC 601-912
FTC

FTC 912 XS
Inox
315.0532.377
7612985487719
341 €



Clase energética: **D**
Ancho: **900 mm**
Mandos: **Mandos mecánicos**
Aspiración (mín-máx-int):
220-320-420
Presión (Pa) (mín-mid-máx):
180-200-220
P. Sonora (dBA) (mín-mid-máx):
57-66-69
Potencia (W) (mín-mid-máx):
90-105-140
Iluminación: **LED 2 x 1W**

135

FTC 601 GR/XS
Inox
110.0439.278
7612981773458
214 €



Clase energética: **D**
Ancho: **600 mm**
Mandos: **Mandos mecánicos**
Aspiración (mín-mid-máx):
225-315-380
Presión (Pa) (mín-mid-máx):
200-220-240
P. Sonora (dBA) (mín-mid-máx):
58-67-69
Potencia (W) (mín-mid-máx):
85-100-140
Iluminación: **LED 2 x 1W**

135

SMART

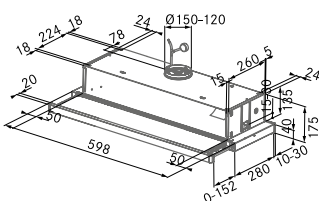
SMART FTC
FTC 632L

FTC 632L GR/XS
Inox
315.0547.796
7612985572613
149 €

FTC 632L WH
Blanco
315.0547.797
7612985572620
149 €

FTC 632L BK
Negro
315.0547.798
7612985572637
149 €



Clase energética: **D**
Ancho: **600 mm**
Mandos: **Mandos mecánicos**
Aspiración (mín-mid-máx):
180-220-310
Presión (Pa) (mín-mid-máx):
230-250-260
P. Sonora (dBA) (mín-mid-máx):
57-62-67
Potencia (W) (mín-mid-máx):
85-100-125
Iluminación: **LED 2 x 1W / 4000 K**
Filtro: **de Aluminio multicapa**

136

Accesorio opcional

135 Filtro carbón activo
112.0282.687
30 €

136 Set 2 filtros
carbón redondos
112.0564.564
18 €

Cubetas

Fregaderos

Grifos

Campanas

Electrodomésticos

Gestión de residuos

Accesorios





Pictogramas



Sound Pro: Reduce el nivel sonoro de 2 a 6 decibelios



Nivel sonoro



Clasificación energética luz



Interacción con el usuario: aplicación móvil, Franke@Home



Clasificación energética ventilador



Función 24h: Circulación y aspiración de aire cada 10 min/h, durante un ciclo de 24 horas.



Clasificación energética filtros

Cubetas

Fregaderos

Grifos

Campanas

Electrodomésticos

Gestión de residuos

Accesorios

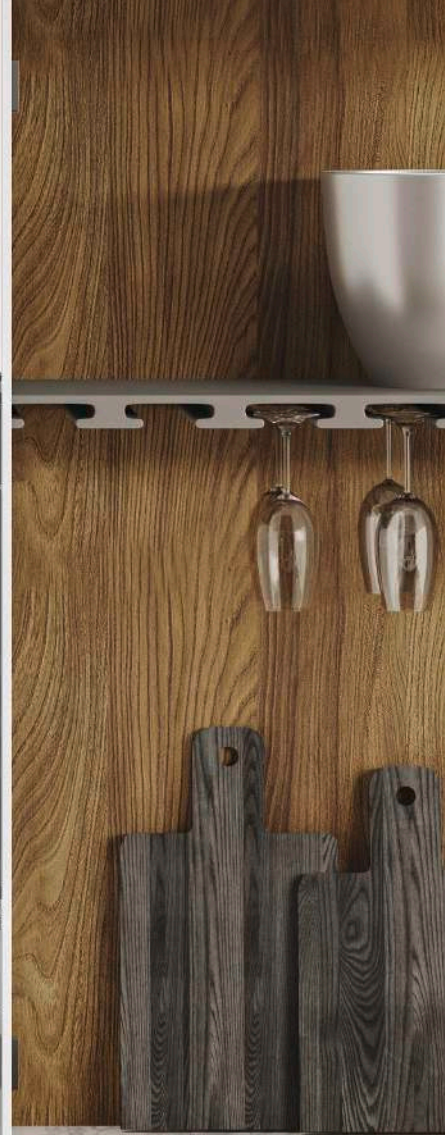



Hornos

266	Mythos
268	Maris
269	Smart
272	Horno-Microondas
274	Microondas
276	Cafeteras
276	Calientaplatos

Hornos

Hornos Pirolíticos

Hornos Hidrolíticos

Hornos Ancho 90 cm

MYTHOS



FMY 99 P XS / BK
p. 266



FMY 98 P XS / BK
p. 267

MARIS



FMA 97 P XS
p. 268



FMY 99 HS XS / BK
p. 266



FMA 86 H XS / BK
p. 268



FSM 97 P XS
p. 269



FSM 86 H BK / XS
p. 269



FSM 86 HE XS
p. 270



EKKO 90 FMXO 86 S XS
p. 271



FSL 86 H BK / WH / XS
p. 270, 271



FSM 82 H XS
p. 270



FSL 82 H XS
p. 271



FSL 52 H XS
p. 271

SMART

Hornos- microondas



FMY 45 MW XS / BK
p. 273



FMA 45 MW XS
p. 273



FSM 45 MW XS
p. 273

Microondas



FMW 250 CR2 G BK
p. 274



FSM 25 MW XS
p. 275



FMW 20 SMP G XS
p. 275



FSL 20 MW BK / XS
p. 275



Cafeteras y calienta platos



FMY 45 CM XS / BK
p. 277



FMY 14 DRW BK / XS
p. 277

MYTHOS

192

100%
VAPOR

Negro/Inox

FMY 99 HS XS
116.0613.706
7612985834797
1.847 €



Tipo: **Horno multifunción con cocción al vapor (depósito de 1.5 lts)**

Clase energética: **A+**

Capacidad: **73 L**

Mandos: **Display táctil TFT**

Número de funciones: **94**

Programas exclusivos: **CookAssist: 60**

recetas automáticas + 15 funciones

especiales; Multicook: cocina a 4 niveles sin

mezcla de olores ni sabores

Cierre puerta: **Smooth2close**

Cristal puerta: **Full glass 3 cristales**

Guías: **1 nivel guías telescópicas**

Accesorios incluidos: **2 rejillas, 1 bandeja,**

1 bandeja profunda

Limpieza: **Sistema de limpieza hidrolítico**

Dimensiones (alto x ancho x fondo) (mm):

595x595x564

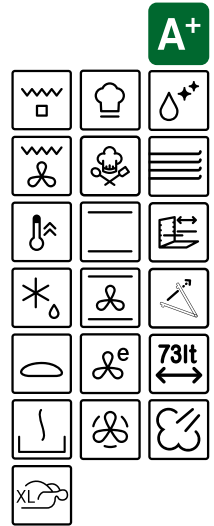

MYTHOS

192

100%
VAPOR

Negro

FMY 99 HS BK
116.0613.707
7612985834803
1.847 €



Tipo: **Horno multifunción con cocción al vapor (depósito de 1.5 lts)**

Clase energética: **A+**

Capacidad: **73 L**

Mandos: **Display táctil TFT**

Número de funciones: **94**

Programas exclusivos: **CookAssist: 60**

recetas automáticas + 15 funciones

especiales; Multicook: cocina a 4 niveles sin

mezcla de olores ni sabores

Cierre puerta: **Smooth2close**

Cristal puerta: **Full glass 3 cristales**

Guías: **1 nivel guías telescópicas**

Accesorios incluidos: **2 rejillas, 1 bandeja,**

1 bandeja profunda

Limpieza: **Sistema de limpieza hidrolítico**

Dimensiones (alto x ancho x fondo) (mm):

595 x 595 x 564



MYTHOS

192

PYRO

Negro/Inox

FMY 99 PXS
116.0613.708
7612985834810
1.269 €



Tipo: **Horno multifunción**

Clase energética: **A+**

Capacidad: **73 L**

Mandos: **Display táctil TFT**

Número de funciones: **74**

Programas exclusivos: **CookAssist: 42**

recetas automáticas + 15 funciones

especiales; Multicook: cocina a 4 niveles sin

mezcla de olores ni sabores

Cierre puerta: **Smooth2close**

Cristal puerta: **Full glass 4 cristales**

Guías: **1 nivel guías telescópicas**

Accesorios incluidos: **2 rejillas, 1 bandeja,**

1 bandeja profunda

Limpieza: **Sistema de limpieza pirolítico**

Dimensiones (alto x ancho x fondo) (mm):

595 x 595 x 564

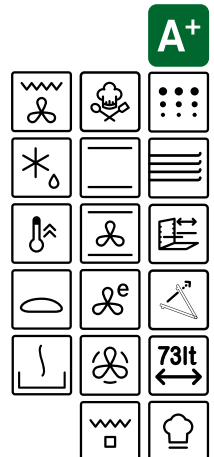

MYTHOS

192

PYRO

Negro

FMY 99 P BK
116.0613.709
7612985834827
1.269 €



Tipo: **Horno multifunción**
Clase energética: **A+**
Capacidad: **73 L**
Mandos: **Display táctil TFT**
Número de funciones: **74**
Programas exclusivos: **CookAssist: 42 recetas automáticas + 15 funciones especiales; Multicook: cocina a 4 niveles sin mezcla de olores ni sabores**
Cierre puerta: **Smooth2close**
Cristal puerta: **Puerta Full glass 4 cristales**
Guías: **1 nivel guías telescópicas**
Accesorios incluidos: **2 rejillas, 1 bandeja, 1 bandeja profunda.**
Limpieza: **Sistema de limpieza pirolítico**
Dimensiones (alto x ancho x fondo) (mm): **595 x 595 x 564**

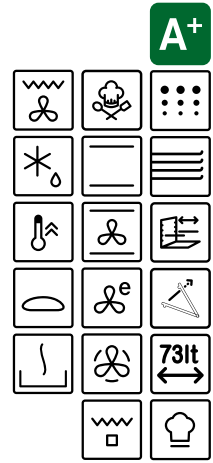

MYTHOS

192

PYRO

Negro/Inox

FMY 98 P XS
116.0606.101
7612985785099
1.108 €



Tipo: **Horno multifunción**
Clase energética: **A+**
Capacidad: **73 L**
Mandos: **Display LCD blanco, mandos Push pull (escamoteables)**
Número de funciones: **19**
Programas exclusivos: **CookAssist: 9 recetas automáticas**
Cierre puerta: **Smooth2close**
Cristal puerta: **Full glass 4 cristales**
Guías: **1 nivel guías telescópicas**
Accesorios incluidos: **2 rejillas, 1 bandeja, 1 bandeja profunda**
Limpieza: **Sistema de limpieza pirolítico**
Dimensiones (alto x ancho x fondo) (mm): **595 x 595 x 564**

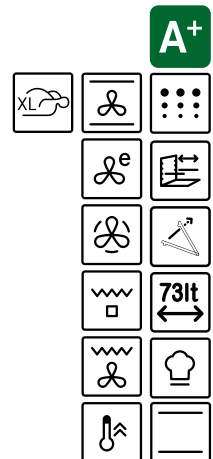

MYTHOS

192

PYRO

Negro

FMY 98 P BK
116.0606.102
7612985785204
1.108 €



Tipo: **Horno multifunción**
Clase energética: **A+**
Capacidad: **73 L**
Mandos: **Display LCD blanco, mandos Push pull (escamoteables)**
Número de funciones: **19**
Programas exclusivos: **CookAssist: 9 recetas automáticas**
Cierre puerta: **Smooth2close**
Cristal puerta: **Full glass 4 cristales**
Guías: **1 nivel guías telescópicas**
Accesorios incluidos: **2 rejillas, 1 bandeja, 1 bandeja profunda**
Limpieza: **Sistema de limpieza pirolítico**
Dimensiones (alto x ancho x fondo) (mm): **595 x 595 x 564**

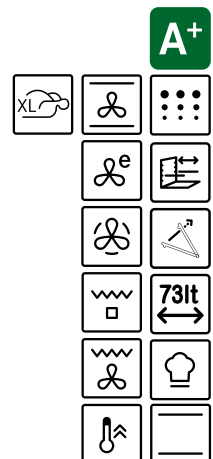

MARIS

193

PYRO

Negro/Inox

FMA 97 P XS
116.0606.100
7612985785082
930 €



Tipo: **Horno multifunción**
Clase energética: **A+**
Capacidad: **71 L**
Mandos: **Display LED blanco, mandos Push pull (escamoteables)**
Número de funciones: **11**
Función especial: **fermentar masa, pan y postres auto**
Cierre puerta: **Smooth2close**
Cristal puerta: **Puerta 3 cristales**
Guías: **1 nivel guías telescópicas**
Accesorios incluidos: **2 rejillas, 1 bandeja, 1 bandeja profunda**
Limpieza: **Sistema de limpieza pirolítico, Press to clean**
Dimensiones (alto x ancho x fondo) (mm): **595 x 595 x 570**

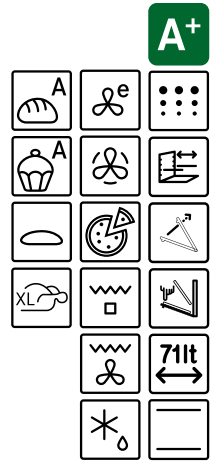

MARIS

193

Negro/Inox

FMA 86 H XS
116.0606.097
7612985785044
792 €



Tipo: **Horno multifunción**
Clase energética: **A**
Capacidad: **71 L**
Mandos: **Display LED blanco, mandos mecánicos**
Número de funciones: **8**
Función especial: **Pan**
Cierre puerta: **Smooth2close**
Cristal puerta: **Puerta 2 cristales**
Accesorios incluidos: **2 rejillas, 1 bandeja, 1 bandeja profunda**
Limpieza: **Sistema de limpieza hidrolítico, Press to clean**
Dimensiones (alto x ancho x fondo) (mm): **595 x 595 x 570**

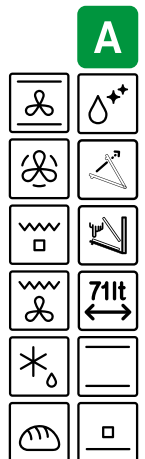

MARIS

193

Negro

FMA 86 HBK
116.0606.098
7612985785068
792 €



Tipo: **Horno multifunción**
Clase energética: **A**
Capacidad: **71 L**
Mandos: **Display LED blanco, mandos mecánicos**
Número de funciones: **8**
Función especial: **Pan**
Cierre puerta: **Smooth2close**
Cristal puerta: **Puerta 2 cristales**
Accesorios incluidos: **2 rejillas, 1 bandeja, 1 bandeja profunda**
Limpieza: **Sistema de limpieza hidrolítico, Press to clean**
Dimensiones (alto x ancho x fondo) (mm): **595 x 595 x 570**

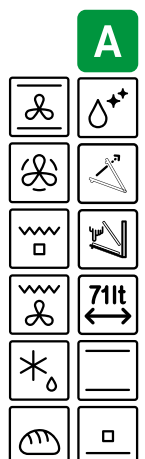

SMART

193

PYRO

Negro/Inox

FSM 97 P XS
116.0606.096
7612985785037
792 €



Tipo: **Horno multifunción**
Clase energética: **A+**
Capacidad: **71 L**
Mandos: **Display LED blanco, mandos mecánicos**
Número de funciones: **11**
Función especial: **fermentar masa, pan y postres auto**
Cierre puerta: **Smooth2close**
Cristal puerta: **Puerta 3 cristales**
Guías: **1 nivel guías telescópicas**
Accesorios incluidos: **2 rejillas, 1 bandeja, 1 bandeja profunda**
Limpieza: **Sistema de limpieza pirolítico, Press to clean**
Dimensiones (alto x ancho x fondo) (mm): **595 x 595 x 570**

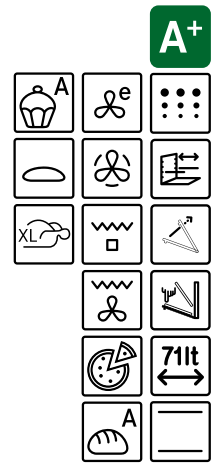

SMART

193

Negro

FSM 86 H BK
116.0606.091
7612985784382
669 €



Tipo: **Horno multifunción**
Clase energética: **A**
Capacidad: **71 L**
Mandos: **Display LED blanco, mandos mecánicos**
Número de funciones: **8**
Función especial: **Pan**
Cierre puerta: **Smooth2close**
Cristal puerta: **Puerta 2 cristales**
Accesorios incluidos: **2 rejillas, 1 bandeja, 1 bandeja profunda**
Limpieza: **Sistema de limpieza hidrolítico, Press to clean**
Dimensiones (alto x ancho x fondo) (mm): **595 x 595 x 570**

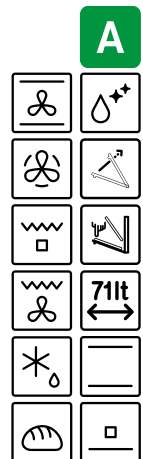

SMART

193

Negro/Inox

FSM 86 H XS
116.0605.990
7612985784375
669 €



Tipo: **Horno multifunción**
Clase energética: **A**
Capacidad: **71 L**
Mandos: **Display LED blanco, mandos mecánicos**
Número de funciones: **8**
Función especial: **Pan**
Cierre puerta: **Smooth2close**
Cristal puerta: **Puerta 2 cristales**
Accesorios incluidos: **2 rejillas, 1 bandeja, 1 bandeja profunda**
Limpieza: **Sistema de limpieza hidrolítico, Press to clean**
Dimensiones (alto x ancho x fondo) (mm): **595 x 595 x 570**

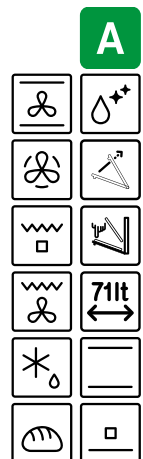

SMART

193



Negro/Inox

FSM 86 HE XS
116.0605.988
7612985784351
600 €



Tipo: **Horno multifunción**
Clase energética: **A**
Capacidad: **71 L**
Mandos: **Display LED rojo, mandos mecánicos**
Número de funciones: **8**
Función especial: **Pan**
Cristal puerta: **Puerta 2 cristales**
Accesorios incluidos: **2 rejillas, 1 bandeja, 1 bandeja profunda**
Limpieza: **Sistema de limpieza hidrolítico, Press to clean**
Dimensiones (alto x ancho x fondo) (mm): **595 x 595 x 570**

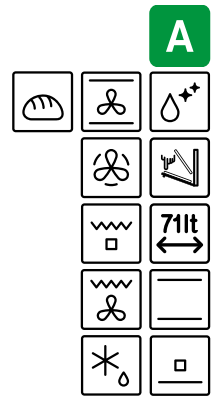

SMART

193



Negro/Inox

FSM 82 H XS
116.0605.987
7612985784344
572 €



Tipo: **Horno multifunción**
Clase energética: **A**
Capacidad: **71 L**
Mandos: **Mandos mecánicos**
Número de funciones: **8**
Función especial: **Pan**
Cierre puerta: **Smooth2close**
Cristal puerta: **Puerta 2 cristales**
Accesorios incluidos: **2 rejillas, 1 bandeja, 1 bandeja profunda**
Limpieza: **Sistema de limpieza hidrolítico, Press to clean**
Dimensiones (alto x ancho x fondo) (mm): **595 x 595 x 570**



SMART

193



Negro

FSL 86 H BK
116.0609.447
7612985804400
576 €



Tipo: **Horno multifunción**
Clase energética: **A**
Capacidad: **71 L**
Mandos: **Display LED rojo, mandos mecánicos**
Número de funciones: **8**
Función especial: **Pan**
Cristal puerta: **Puerta 2 cristales**
Accesorios incluidos: **2 rejillas, 1 bandeja, 1 bandeja profunda**
Limpieza: **Sistema de limpieza hidrolítico, Press to clean**
Dimensiones (alto x ancho x fondo) (mm): **595 x 595 x 570**

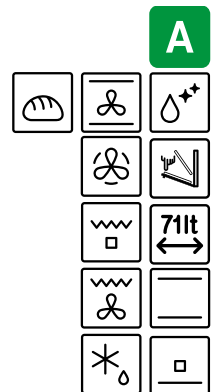

SMART

193



Blanco

FSL 86 H WH
116.0609.448
7612985804417
576 €



Tipo: **Horno multifunción**
Clase energética: **A**
Capacidad: **71 L**
Mandos: **Display LED rojo, mandos mecánicos**
Número de funciones: **8**
Función especial: **Pan**
Cristal puerta: **Puerta 2 cristales**
Accesorios incluidos: **2 rejillas, 1 bandeja, 1 bandeja profunda**
Limpieza: **Sistema de limpieza hidrolítico, Press to clean**
Dimensiones (alto x ancho x fondo) (mm): **595 x 595 x 570**



Electrodomésticos

SMART

193

Inox

FSL 86 H XS
116.0609.446
7612985804394
576 €



Tipo: **Horno multifunción**
Clase energética: **A**
Capacidad: **71 L**
Mandos: **Display LED rojo, mandos mecánicos**
Número de funciones: **8**
Función especial: **Pan**
Cristal puerta: **Puerta 2 cristales**
Accesorios incluidos: **2 rejillas, 1 bandeja, 1 bandeja profunda**
Limpieza: **Sistema de limpieza hidrolítico, Press to clean**
Dimensiones (alto x ancho x fondo) (mm): **595 x 595 x 570**



SMART

193

Inox

FSL 82 H XS
116.0609.445
7612985804387
449 €



Tipo: **Horno multifunción**
Clase energética: **A**
Capacidad: **71 L**
Mandos: **Mandos mecánicos**
Número de funciones: **8**
Función especial: **Pan**
Cristal puerta: **Puerta 2 cristales**
Accesorios incluidos: **2 rejillas, 1 bandeja, 1 bandeja profunda**
Limpieza: **Sistema de limpieza hidrolítico, Press to clean**
Dimensiones (alto x ancho x fondo) (mm): **595 x 595 x 570**

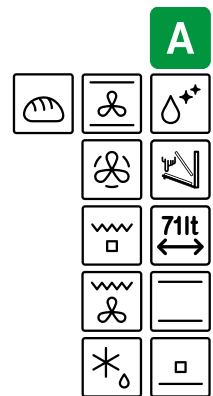

SMART

193

Inox

FSL 52 H XS
116.0609.444
7612985804370
426 €



Tipo: **Horno multifunción**
Clase energética: **A**
Capacidad: **71 L**
Mandos: **Mandos mecánicos**
Número de funciones: **5**
Cristal puerta: **Puerta 2 cristales**
Accesorios incluidos: **2 rejillas, 1 bandeja, 1 bandeja profunda**
Limpieza: **Sistema de limpieza hidrolítico, Press to clean**
Dimensiones (alto x ancho x fondo) (mm): **595 x 595 x 570**

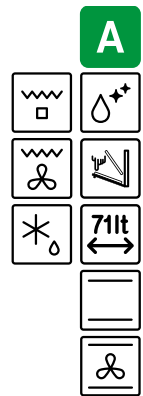

SMART

Inox

EKKO 90
FMXO 86 S XS
116.0613.109
7612985818797
1.651 €



Tipo: **Horno multifunción**
Clase energética: **A**
Capacidad: **84 L**
Mandos: **Display LED rojo, mandos mecánicos**
Número de funciones: **8**
Función especial Eco: **Ideal para alimentos precocinados, congelados o porciones pequeñas. Permite reducir el consumo gracias a un tiempo de precalentamiento muy corto y una cocción más lenta.**
Cristal puerta: **Puerta 2 cristales**
Accesorios incluidos: **1 rejilla, 1 bandeja profunda**
Limpieza: **Sistema de limpieza estándar**
Dimensiones (alto x ancho x fondo) (mm): **477 x 893 x 538**

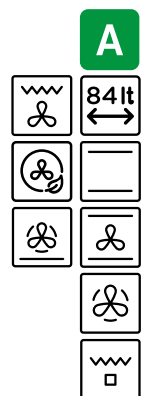

Electrodomésticos

Horno- microondas



Electrodomésticos

MYTHOS



Negro/Inox

FMY 45 MW XS
131.0606.105
7612985785235
1.096 €



Tipo: **Horno microondas combinado**
Capacidad: **40 L**
Mandos: **Display LCD blanco, mandos Push Pull**
Programas exclusivos: **CookAssist: 10 recetas automáticas asistente de cocción**
Cierre puerta: **Smooth2close**
Accesorios incluidos: **Plato giratorio (mm): 360, 1 rejilla grill, 1 bol-vaporera, 1 bandeja para hornear, tapa de plástico**
Cavidad interior: **acero Inox**
Dimensiones (alto x ancho x fondo) (mm): **455 x 595 x 560**
Potencia microondas: **900W**
Potencia grill: **1600W**



MYTHOS



Negro

FMY 45 MW BK
131.0632.660
7612985930550
1.096 €



Tipo: **Horno microondas combinado**
Capacidad: **40 L**
Mandos: **Display LCD blanco, mandos Push Pull**
Programas exclusivos: **CookAssist: 10 recetas automáticas asistente de cocción**
Cierre puerta: **Smooth2close**
Accesorios incluidos: **Plato giratorio (mm): 360, 1 rejilla grill, 1 bol-vaporera, 1 bandeja para hornear, tapa de plástico**
Cavidad interior: **acero Inox**
Dimensiones (alto x ancho x fondo) (mm): **455 x 595 x 560**
Potencia microondas: **900W**
Potencia grill: **1600W**

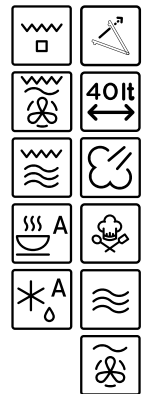

MARIS



Negro/Inox

FMA 45 MW XS
131.0606.104
7612985785228
930 €



Tipo: **Horno microondas combinado**
Capacidad: **40 L**
Mandos: **Display LCD blanco, mandos Push Pull**
Programas exclusivos: **5 recetas automáticas + 15 funciones especiales**
Cierre puerta: **Smooth2close**
Accesorios incluidos: **Plato giratorio (mm): 360, 1 rejilla grill, 1 bandeja para hornear, tapa de plástico**
Cavidad interior: **acero Inox**
Dimensiones (alto x ancho x fondo) (mm): **455 x 595 x 560**
Potencia microondas: **900W**
Potencia grill: **1600W**

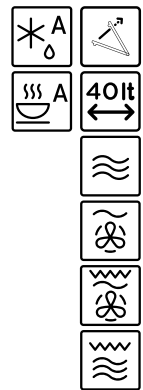

SMART



Negro/Inox

FSM 45 MW XS
131.0606.103
7612985785211
888 €



Tipo: **Horno microondas combinado**
Capacidad: **40 L**
Mandos: **Display LCD blanco, mandos Push Pull**
Programas exclusivos: **5 recetas automáticas + 15 funciones especiales**
Cierre puerta: **Smooth2close**
Accesorios incluidos: **Plato giratorio (mm): 360, 1 rejilla grill, 1 bandeja para hornear, tapa de plástico**
Cavidad interior: **acero Inox**
Dimensiones (alto x ancho x fondo) (mm): **455 x 595 x 560**
Potencia microondas: **900W**
Potencia grill: **1600W**

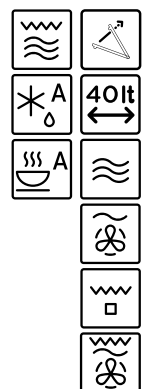

Microondas



Electrodomésticos

MARIS

 Negro

BLACK FMW 250
CR2 G BK
131.0391.304
7612981685522
526 €



Tipo: **Microondas con grill**
Capacidad: **25 L**
Mandos: **Display LED blanco,**
mando electrónico
Nº Programas Automáticos: **8**
Programas exclusivos: **Multicooking:**
programa dos tipos de cocción al mismo
tiempo
Temporizador: **95 min**
Cierre puerta: **Apertura lateral**
Accesorios incluidos: **Plato giratorio (mm):**
315, 1 rejilla grill
Cavidad interior: **acero Inox**
Dimensiones (alto x ancho x fondo) (mm):
388 x 595 x 400
Potencia microondas: **900W**
Potencia grill: **1000W**



SMART



Negro/Inox

FSM 25 MW XS
131.0627.471
7612985906982
491 €



Tipo: **Microondas con grill**
Capacidad: **25 L**
Mandos: **Display LED blanco, mando electrónico**
N° Programas Automáticos: **8**
Programas exclusivos: **Multicooking: programa dos tipos de cocción al mismo tiempo**
Temporizador: **95 min**
Cierre puerta: **Apertura lateral**
Accesorios incluidos: **Plato giratorio (mm): 315, 1 rejilla grill**
Cavidad interior: **acero Inox**
Dimensiones (alto x ancho x fondo) (mm): **388 x 595 x 400**
Potencia microondas: **900W**
Potencia grill: **1000W**



SMART



Negro/Inox

FMW 20 SMP G XS
131.0574.627
7612985670616
415 €



Tipo: **Microondas con grill**
Capacidad: **20 L**
Mandos: **Display LED rojo, mando giratorio + electrónico**
N° Programas Automáticos: **8**
Programas exclusivos: **Multicooking: programa dos tipos de cocción al mismo tiempo**
Temporizador: **95 min**
Cierre puerta: **Apertura lateral**
Accesorios incluidos: **Plato giratorio (mm): 245, 1 rejilla grill**
Cavidad interior: **acero Inox**
Dimensiones (alto x ancho x fondo) (mm): **388 x 595 x 343.5**
Potencia microondas: **800W**
Potencia grill: **1000W**



SMART



Negro

FSL 20 MW BK
131.0632.993
7612985930857
380 €



Tipo: **Microondas con grill**
Capacidad: **20 L**
Mandos: **Display LED rojo, mando giratorio + electrónico**
N° Programas Automáticos: **8**
Programas exclusivos: **Multicooking: programa dos tipos de cocción al mismo tiempo**
Temporizador: **95 min**
Cierre puerta: **Apertura lateral**
Accesorios incluidos: **Plato giratorio (mm): 245, 1 rejilla grill**
Dimensiones (alto x ancho x fondo) (mm): **388 x 595 x 343.5**
Potencia microondas: **800W**
Potencia grill: **1000W**



SMART



Negro/Inox

FSL 20 MW XS
131.0632.992
7612985930840
380 €



Tipo: **Microondas con grill**
Capacidad: **20 L**
Mandos: **Display LED rojo, mando giratorio + electrónico**
Programas exclusivos: **Multicooking: programa dos tipos de cocción al mismo tiempo**
Temporizador: **95 min**
Cierre puerta: **Apertura lateral**
Accesorios incluidos: **Plato giratorio (mm): 245, 1 rejilla grill**
Dimensiones (alto x ancho x fondo) (mm): **388 x 595 x 343.5**
Potencia microondas: **800W**
Potencia grill: **1000W**



Electrodomésticos

Cafetera y calientaplatos





Negro/Inox

FMY 45 CM XS
131.0627.473
7612985906999
2.193 €



Tipo: **Cafetera Integrable**

Capacidad de depósito de agua: **1.8 L**

Capacidad del cajón de granos de café: **200 gr**

Mandos: **Panel de control electrónico Táctil con LCD blanco.**

Número de tamaños de tazas: **5**

Número de funciones: **8**

Función preparación 1 ó 2 tazas

Selección tamaño de taza: **Espresso, taza pequeña, taza mediana, taza grande, jarra**

Niveles de intensidad del café: **5 (sabor extra suave, suave, normal, fuerte o extra fuerte)**

Función agua caliente

Molinillo de café integrado, se puede elegir el grosor del molido (Opción de café premolido)

Guías telescópicas/ Guías correderas con cierre / Apertura suave

Accesorios: **1x jarra de leche y 1x cuchara medidora de café**

Dimensiones (alto x ancho x fondo) (mm): **456 x 595 x 412**



Negro



FMY 45 CM BK
131.0682.091
7612986232868
2.193 €



Tipo: **Cafetera Integrable**

Capacidad de depósito de agua: **1.8 L**

Capacidad del cajón de granos de café: **200 gr**

Mandos: **Panel de control electrónico Táctil con LCD blanco.**

Número de tamaños de tazas: **5**

Número de funciones: **8**

Función preparación 1 ó 2 tazas

Selección tamaño de taza: **Espresso, taza pequeña, taza mediana, taza grande, jarra**

Niveles de intensidad del café: **5 (sabor extra suave, suave, normal, fuerte o extra fuerte)**

Función agua caliente

Molinillo de café integrado, se puede elegir el grosor del molido (Opción de café premolido)

Guías telescópicas/ Guías correderas con cierre / Apertura suave

Accesorios: **1x jarra de leche y 1x cuchara medidora de café**

Dimensiones (alto x ancho x fondo) (mm): **456 x 595 x 412**



FMY 14 DRW BK
Negro
131.0640.710
7612985969697
792 €

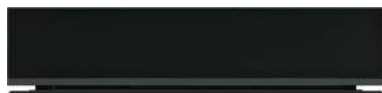

Tipo: **Calientaplatos Integrable**

Voltaje: **220-240 V**

Frecuencia: **50/60 Hz**

Corriente eléctrica: **18 A**

Capacidad: **16 L**

Usos: **Pre calentamiento de ollas, cacerolas y tazas, mantener la comida caliente, descongelar, fermentar masa (entre 28° - 30°)**

Dimensiones (alto x ancho x fondo) (mm):

134.5 x 595 x 568



FMY 14 DRW XS
Negro/Inox
131.0611.212
7612985813570
792 €



Temperatura		Instrucciones de uso
40°C	Tazas, Vasos	Las tazas y vasos calentados a esta temperatura retrasa el enfriamiento de las mismas
60°C	Platos	Las preparaciones /recetas calentadas a esta temperatura retrasa el enfriamiento de las mismas
75°C	Vajillas	El termostato se configura a la máxima temperatura



Placas

212

Inducción con campana

282

Inducción

288

Vitrocerámica

290

Placas de gas





Cubetas

Fregaderos

Grifos

Campanas

Electrodomésticos

Gestión de residuos

Accesorios

Placas

Inducción con Campana Integrada

Inducción

MYTHOS



FMY 839 HE
p. 217



FMY 839 HI 2.0
p. 219



FMY 906 I FP BK
p. 284



FMY 808 I FP BK
p. 284



FMY 658 I FP BK
p. 284

MARIS



FMA 839 HI
p. 221



FMA 654 XS
p. 285



FMA 804 I F BK
p. 285



FMA 654 I F BK
p. 285

SMART



FSM 709 HI
p. 223



FSM 804 I B BK
p. 286



FSM 653 I D BK
p. 286



FSM 654 I BK
p. 286



FSM 302 I BK
p. 287

Vitrocerámica

Placas de Gas



FHCN 1204 3G TC HE BK
p. 292



FHCN 755 4G TC HE BK
p. 292



FHCN 604 HE BK C
p. 292



FHCN 905 4G TC HE BK C
p. 293



FHCN 302 2G HE BK C
p. 293



FRSM 603 C TD BK
p. 289



FRSM 604 C T BK
p. 289



FRSM 302 C TD BK
p. 289



FHNS 705 4G TC BK C / WH C
p. 294



FHNS 604 4G BK C / WH C
p. 294



FHNS 604 4G BK C / WH C
p. 294



FHNS 604 4G BK C / WH C
p. 294



FHSM 755 4G DCL XS C
p. 295



FHSM 604 4G DCL XS C
p. 295



FHNL 705 4G TC XS E
p. 295

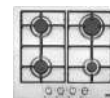

FHNL 604 4G XS E
p. 295

Cubetas

Fregaderos

Grifos

Campanas

Electrodomésticos

Gestión de residuos

Accesorios





Cubetas

Fregaderos

Grifos

Campanas

Electrodomésticos

Gestión de residuos

Accesorios

Placas Inducción

284	Mythos
285	Maris
286	Smart
288	Vitrocerámica

MYTHOS



NEW

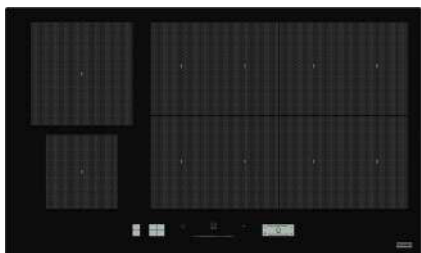

FMY 906 | FP BK
108.0675.431
 7612986203479
2.199 €

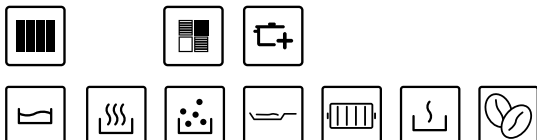

Tipo: **Placa de Inducción**

Total Flex Pro: **Sí**

EasyCook: **Sí**

ProCook: **Sí**

Zonas de cocción: **6**

Display: **Luz LED blanca**

Niveles de potencia: **18 + booster**

Funciones automáticas: **Sí**

Temporizador: **Sí**

Instalación recomendada: **Estándar / Encastre (r 5 cristal), ventilación trasera (ver manual de instalación)**

Bloqueo de seguridad para niños

Indicador de calor residual

Potencia de cada zona de cocción: **1200W - Booster 1850W**

Dimensiones (alto x ancho x fondo) (mm): **57 x 860 x 510**

Dimensiones de encastre (mm): **840 x 490 min.**

Regulador de potencia: **4.0kW - 6.0kW - 7.4kW - 11kW**

Potencia total: **11kW**

MYTHOS



FMY 808 | FP BK
108.0613.588
 7612985820455
1.835 €

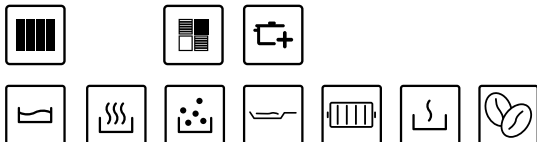

Tipo: **Placa de Inducción**

Total Flex Pro: **Sí**

EasyCook: **Sí**

ProCook: **Sí**

Zonas de cocción: **8**

Display: **Luz LED blanca**

Niveles de potencia: **18 + booster**

Funciones automáticas: **8**

Temporizador: **Sí**

Instalación recomendada: **Estándar / Encastre (r 5 cristal), ventilación trasera (ver manual de instalación)**

Bloqueo de seguridad para niños

Indicador de calor residual

Potencia de cada zona de cocción: **1200W - Booster 1800W**

Dimensiones (alto x ancho x fondo) (mm): **57 x 770 x 510**

Dimensiones de encastre (mm): **750 x 480 min. (máx, 492)**

Regulador de potencia: **2.5kW - 4.0kW - 6.0kW - 7.4kW**

Potencia total: **7.4kW**

MYTHOS



FMY 658 | FP BK
108.0613.587
 7612985820448
1.397 €

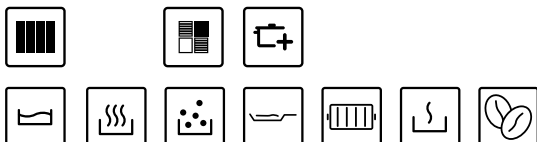

Tipo: **Placa de Inducción**

Total Flex Pro: **Sí**

EasyCook: **Sí**

ProCook: **Sí**

Zonas de cocción: **8**

Display: **Luz LED blanca**

Niveles de potencia: **18 + booster**

Funciones automáticas: **8**

Temporizador: **Sí**

Instalación recomendada: **Estándar / Encastre (r 5 cristal), ventilación trasera (ver manual de instalación)**

Bloqueo de seguridad para niños

Indicador de calor residual

Potencia de cada zona de cocción: **1200W - Booster 1800W**

Dimensiones (alto x ancho x fondo) (mm): **57 x 650 x 510**

Dimensiones de encastre (mm): **560 x 480 min. (máx, 492)**

Regulador de potencia: **2.5kW - 4.0kW - 6.0kW - 7.4kW**

Potencia total: **7.4kW**

NEW

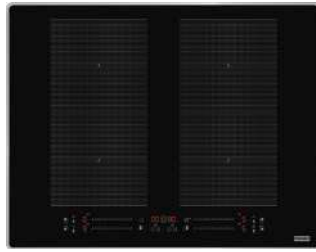

FMA 654 XS
108.0675.410
 7612986203462
999 €

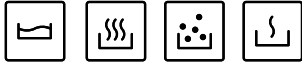

ZONA 2 1750W - B:2000W ProCook Hervir	ZONA 3 1750W - B:2000W ProCook Mantener caliente
ZONA 1 1750W - B:2000W ProCook Derretir	ZONA 4 1750W - B:2000W ProCook Fuego lento

Tipo: **Placa de Inducción**

Zona Flex: **Sí**

ProCook: **Sí**

Zonas de cocción: **4**

Mando: **Touch con slider rojo**

Display: **Luz LED roja**

Niveles de potencia: **18 + booster**

Funciones automáticas: **2**

Temporizador: **Sí**

Instalación recomendada: **Estándar / Encastre (r 5 cristal), ventilación trasera (ver manual de instalación)**

Bloqueo de seguridad para niños

Indicador de calor residual

Dimensiones (alto x ancho x fondo) (mm): **56 x 658 x 518**

Dimensiones de encastre (mm): **560 x 480 min. (492 máx. ; r máx. 10 mm)**

Regulador de potencia: **2.5kW – 4.0kW – 6.0kW – 7.2kW**

Potencia total: **7.2kW**



FMA 804 I F BK
108.0606.112
 7612985785303
977 €

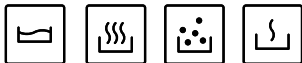

ZONA 2 Ø 200x170mm 1750W - B:2200W Derretir Mantener caliente	ZONA 3 Ø 210mm 2100W - B:3000W Fuego lento Hervir
ZONA 1 Ø 200x170mm 1750W - B:2200W Fuego lento Hervir	ZONA 4 Ø 145mm 1200W - B:1600W Derretir Mantener caliente

Tipo: **Placa de Inducción**

Zona Flex: **Sí**

Zonas de cocción: **4**

Mando: **Touch control con slider**

Display: **Luz LED roja**

Niveles de potencia: **18 + booster**

Funciones automáticas: **2**

Temporizador: **Sí**

Instalación recomendada: **Estándar / Encastre (r 5 cristal), ventilación trasera (ver manual de instalación)**

Bloqueo de seguridad para niños

Indicador de calor residual

Dimensiones (alto x ancho x fondo) (mm): **54 x 770 x 510**

Dimensiones de encastre (mm): **750 x 480 min. (máx, 492)**

Regulador de potencia: **2.5kW – 4.0kW – 6.0kW – 7.2kW**

Potencia total: **7.2kW**

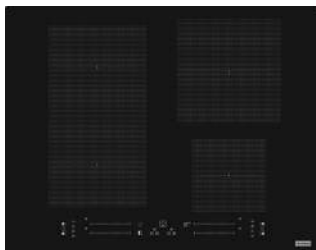

FMA 654 I F BK
108.0606.111
 7612985785297
792 €

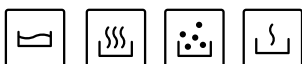

ZONA 2 Ø 200x170mm 1750W - B:2200W Derretir Mantener caliente	ZONA 3 Ø 210mm 2100W - B:3000W Fuego lento Hervir
Ø ZONA 1 200x170mm 1750W - B:2200W Fuego lento Hervir	ZONA 4 Ø 145mm 1200W - B:1600W Derretir Mantener caliente

Tipo: **Placa de Inducción**

Zona Flex: **Sí**

Zonas de cocción: **4**

Mando: **Touch control con slider**

Display: **Luz LED roja**

Niveles de potencia: **18 + booster**

Funciones automáticas: **2**

Temporizador: **Sí**

Instalación recomendada: **Estándar / Encastre (r 5 cristal), ventilación trasera (ver manual de instalación)**

Bloqueo de seguridad para niños

Indicador de calor residual

Dimensiones (alto x ancho x fondo) (mm): **54 x 650 x 510**

Dimensiones de encastre (mm): **560 x 480 min. (máx, 492)**

Regulador de potencia: **2.5kW – 4.0kW – 6.0kW – 7.2kW**

Potencia total: **7.2kW**

SMART

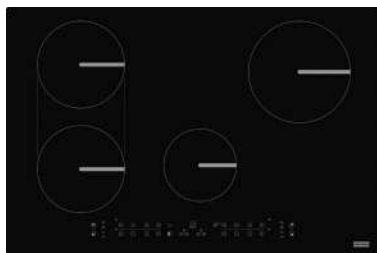

FSM 804 I B BK
108.0606.110
 7612985785280
734 €



ZONA 2
 Ø 180mm
 1800W - B:2100W
 Fuego lento | Hervir

ZONA 3
 Ø 210mm
 2100W - B:3000W
 Fuego lento | Hervir

ZONA 1
 Ø 180mm
 1800W - B:2100W
 Derretir | Mantener calienter

ZONA 4
 Ø 145mm
 1200W - B:1600W
 Derretir | Mantener caliente

Tipo: **Placa de Inducción**

Zona Punteo: **Sí**

Zonas de cocción: **4**

Mando: **Touch control directo**

Display: **Luz LED roja**

Niveles de potencia: **9 + booster**

Funciones automáticas: **2**

Temporizador: **Sí**

Instalación recomendada: **Estándar / Encastre (r 5 cristal), ventilación trasera (ver manual de instalación)**

Bloqueo de seguridad para niños

Indicador de calor residual

Dimensiones (alto x ancho x fondo) (mm): **54 x 770 x 510**

Dimensiones de encastre (mm): **750 x 480 min. (máx, 492)**

Regulador de potencia: **2.5kW - 4.0kW - 6.0kW - 7.2kW**

Potencia total: **7.2kW**

SMART



FSM 653 I D BK
108.0606.109
 7612985785273
611 €



ZONA 2
 Ø 180mm
 1800W - B:2100W
 Mantener caliente

ZONA 3
 Ø 290mm
 2100W - B:3600W
 Hervir

ZONA 1
 Ø 180mm
 1800W - B:2100W
 Derretir

Tipo: **Placa de Inducción**

Zona Punteo: **Sí**

Zonas de cocción: **3 + 1 doble corona**

Mando: **Touch control directo - Central +/-**

Display: **Luz LED roja**

Niveles de potencia: **9 + booster**

Funciones automáticas: **2**

Temporizador: **Sí**

Instalación recomendada: **Estándar / Encastre (r 5 cristal), ventilación trasera (ver manual de instalación)**

Bloqueo de seguridad para niños

Indicador de calor residual

Dimensiones (alto x ancho x fondo) (mm): **54 x 650 x 510**

Dimensiones de encastre (mm): **560 x 480 min. (máx, 492)**

Regulador de potencia: **2.5kW - 4.0kW - 6.0kW - 7.2kW**

Potencia total: **7.2kW**

SMART



FSM 654 I BK
108.0606.108
 7612985785266
576 €



ZONA 2
 Ø 210mm
 2100W - B:3000W
 Fuego lento | Hervir

ZONA 3
 Ø 180mm
 1800W - B:2100W
 Fuego lento | Hervir

ZONA 1
 Ø 145mm
 1200W - B:1600W
 Derretir | Mantener calienter

ZONA 4
 Ø 180mm
 1800W - B:2100W
 Derretir | Mantener caliente

Tipo: **Placa de Inducción**

Zona Punteo: **Sí**

Zonas de cocción: **4**

Mando: **Touch control directo**

Display: **Luz LED roja**

Niveles de potencia: **9 + booster**

Funciones automáticas: **2**

Temporizador: **Sí**

Instalación recomendada: **Estándar / Encastre (r 5 cristal), ventilación trasera (ver manual de instalación)**

Bloqueo de seguridad para niños

Indicador de calor residual

Dimensiones (alto x ancho x fondo) (mm): **54 x 650 x 510**

Dimensiones de encastre (mm): **560 x 480 min. (máx, 492)**

Regulador de potencia: **2.5kW - 4.0kW - 6.0kW - 7.2kW**

Potencia total: **7.2kW**

SMART

FSM 302 I BK
108.0606.106
7612985785242
484 €



ZONA 2
Ø 210mm
2100W - B:3000W
Hervir

ZONA 1
Ø 145mm
1200W - B:1600W
Derretir

Tipo: **Placa de Inducción**

Zonas de cocción: **2**

Mando: **Touch control directo - Central +/-**

Display: **Luz LED roja**

Niveles de potencia: **9 + booster**

Funciones automáticas: **1**

Temporizador: **Sí**

Instalación recomendada: **Estándar / Encastre (r 5 cristal), ventilación trasera (ver manual de instalación)**

Bloqueo de seguridad para niños

Indicador de calor residual

Dimensiones (alto x ancho x fondo) (mm): **54 x 284 x 510**

Regulador de potencia: **2.5kW a 3.7 kW**

Potencia total: **3.7kW**

Cubetas

Fregaderos

Girifos

Campanas

Electrodomésticos

Gestión de residuos

Accesorios

Vitro cerámicas



SMART

FRSM 603 C TD BK
108.0669.348
7612986168662
449 €



Tipo: **Placa Vitrocerámica**
N° de fuegos: **3**
Mando: **Touch control directo**
Display: **Luz LED roja**
Bloqueo de seguridad para niños
Dimensiones (ancho x fondo) (mm): **580 x 510 mm**
Dimensiones encastre: **560 x 490 mm**
Potencia máxima: **5300 W**

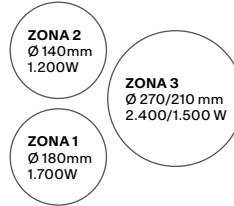

SMART

FRSM 604 C T BK
108.0669.349
7612986168679
429 €



Tipo: **Placa Vitrocerámica**
N° de fuegos: **4**
Mandos: **Touch control directo**
Display: **Luz LED roja**
Bloqueo de seguridad para niños
Dimensiones (ancho x fondo) (mm): **580 x 510 mm**
Dimensiones encastre: **560 x 490 mm**
Potencia máxima: **6300 W**

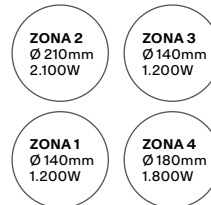

SMART

FRSM 302 C TD BK
108.0669.347
7612986168655
289 €

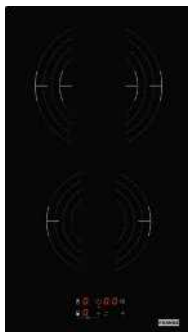

Tipo: **Placa Vitrocerámica**
N° de fuegos: **2**
Mandos: **Touch control directo**
Display: **Luz LED roja**
Bloqueo de seguridad para niños
Dimensiones (ancho x fondo) (mm): **288 x 510 mm**
Dimensiones encastre: **268 x 490 mm**
Potencia máxima: **2900 W**

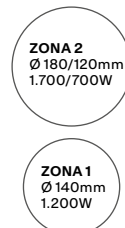

Cubetas

Fregaderos

Grifos

Campanas

Electrodomésticos

Gestión de residuos

Accesorios

Cubetas

Fregaderos

Grifos

Campanas

Electrodomésticos

Gestión de residuos

Accesorios





Cubetas

Fregaderos

Girfos

Campanas

Electrodomésticos

Gestión de residuos

Accesorios

Placas de Gas

292

294

Mythos

Smart

MYTHOS



NEW

FHCR 1204 3G TC HE BK
106.0374.292
 7612981604486
849 €



Tipo: **Placa Gas Cristal**
 Quemador: **Parrillas de fundición**
Válvulas de seguridad
 Número de fuegos: **4**
 Encendido: **Eléctrico**
 Acabado: **Cristal negro templado**
 Quemadores: **Planos de alta eficiencia**
1 quemador Auxiliar 1.000 W
1 quemador Semirápido 1.750 W
1 quemador Rápido 3.000 W
1 quemador Doble Corona 4.000 W
 Dimensiones (alto x ancho x fondo) (mm): **40 x 1180 x 410**
 Dimensiones encastre: **1140 x 380 mm**

MYTHOS



NEW

FHCR 755 4G TC HE BK
106.0374.283
 7612981604400
799 €



Tipo: **Placa Gas Cristal**
 Quemador: **Parrillas de fundición**
Válvulas de seguridad
 Número de fuegos: **5**
 Encendido: **Eléctrico**
 Acabado: **Cristal negro templado**
 Quemadores: **Planos de alta eficiencia**
1 quemador Auxiliar 1.000 W
2 quemador Semirápidos 2.000 W
1 quemador Semirápido 1.750 W
1 quemador Doble Corona 4.000 W
 Dimensiones (alto x ancho x fondo) (mm): **40 x 750 x 510**
 Dimensiones encastre: **560 x 480 mm**

MYTHOS



FHCR 604 HE BK C
106.0374.280
 7612981604370
749 €



Tipo: **Placa Gas Cristal**
 Quemador: **Parrillas de fundición**
Válvulas de seguridad
 Número de fuegos: **4**
 Encendido: **Eléctrico**
 Acabado: **Cristal negro templado**
 Quemadores: **Planos de alta eficiencia**
1 quemador Auxiliar 1.000 W
2 quemador Semirápidos 1.750 W
1 quemador Rápido 3.000 W
 Dimensiones (alto x ancho x fondo) (mm): **40 x 750 x 510**
 Dimensiones encastre: **560 x 480 mm**

MYTHOS



FHCR 905 4G TC HE BK C
106.0374.288
7612981604455
1.219 €



Tipo: **Placa Gas Cristal**
Quemador: **Parrillas de fundición**
Válvulas de seguridad
Número de fuegos: **5**
Encendido: **Eléctrico**
Acabado: **Cristal negro templado**
Quemadores: **Planos de alta eficiencia**
1 quemador Auxiliar 1.000 W
2 quemadores Semirápidos 1.750 W
1 quemador Rápido 3.000 W
1 quemador Wok triple llama 4.000 W
Dimensiones (alto x ancho x fondo) (mm): **40 x 880 x 510**
Dimensiones encastre: **840 x 480 mm**

MYTHOS



FHCR 302 2G HE BK C
106.0374.278
7612981604363
538 €



Tipo: **Placa Gas Cristal**
Quemador: **Parrillas de fundición**
Válvulas de seguridad
Número de fuegos: **2**
Encendido: **Eléctrico**
Acabado: **Cristal negro templado**
Quemadores: **Planos de alta eficiencia**
1 quemador Auxiliar 1.000 W
1 quemador Rápido 3.000 W
Dimensiones (alto x ancho x fondo) (mm): **40 x 310 x 510**
Dimensiones encastre: **250 x 480 mm**

Cubetas

Fregaderos

Girifos

Campanas

Electrodomésticos

Gestión de residuos

Accesorios

SMART

FHNS 705 4G TC BK C
106.0490.102
 7612981900359
519 €



Tipo: **Placa Glass Linear**
 Quemador: **Parrillas de fundición**
Válvulas de seguridad
 Número de fuegos: **5**
 Encendido: **Eléctrico**
 Acabado: **Cristal templado biselado negro**
 Quemadores: **Planos de alta eficiencia**
1 quemador Auxiliar 1.000 W
2 quemadores Semirápidos 1.750 W
1 quemador Rápidos 3.000 W
1 quemador Wok triple llama 3.800 W
 Dimensiones (alto x ancho x fondo) (mm): **40 x 680 x 520**
 Dimensiones encastre: **560 x 490 mm**

SMART

FHNS 705 4G TC WH C
106.0490.103
 7612981900366
530 €



Tipo: **Placa Glass Linear**
 Quemador: **Parrillas de fundición**
Válvulas de seguridad
 Número de fuegos: **5**
 Encendido: **Eléctrico**
 Acabado: **Cristal templado biselado blanco**
 Quemadores: **Planos de alta eficiencia**
1 quemador Auxiliar 1.000 W
2 quemadores Semirápidos 1.750 W
1 quemador Rápidos 3.000 W
1 quemador Wok triple llama 3.800 W
 Dimensiones (alto x ancho x fondo) (mm): **40 x 680 x 520**
 Dimensiones encastre: **560 x 490 mm**

SMART

FHNS 604 4G BK C
106.0489.940
 7612981899714
392 €

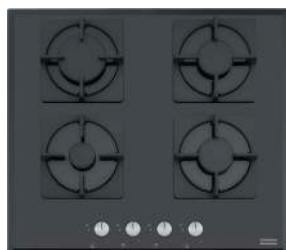

Tipo: **Placa Glass Linear**
 Quemador: **Parrillas de fundición**
Válvulas de seguridad
 Número de fuegos: **4**
 Encendido: **Eléctrico**
 Acabado: **Cristal templado biselado negro**
 Quemadores: **Planos de alta eficiencia**
1 quemador Auxiliar 1.000 W
2 quemadores Semirápidos 1.750 W
1 quemador Doble corona 3.000 W
 Dimensiones (alto x ancho x fondo) (mm): **40 x 590 x 520**
 Dimensiones encastre: **560 x 490 mm**

SMART

FHNS 604 4G WH C
106.0489.961
 7612981899820
403 €



Tipo: **Placa Glass Linear**
 Quemador: **Parrillas de fundición**
Válvulas de seguridad
 Número de fuegos: **4**
 Encendido: **Eléctrico**
 Acabado: **Cristal templado biselado blanco**
 Quemadores: **Planos de alta eficiencia**
1 quemador Auxiliar 1.000 W
2 quemadores Semirápidos 1.750 W
1 quemador Doble corona 3.000 W
 Dimensiones (alto x ancho x fondo) (mm): **40 x 590 x 520**
 Dimensiones encastre: **560 x 490 mm**

SMART

FHSM 755 4G DCL XS C
106.0554.394
7612985576819
576 €



Tipo: **Placa Gas**
Quemador: **Parrillas de fundición**
Válvulas de seguridad
Número de fuegos: **5**
Encendido: **Eléctrico**
Quemadores: **Planos de alta eficiencia**
1 quemador Auxiliar 1.000 W
2 quemadores Semirápidos 1.750 W
1 quemador Doble corona 3.500 W
1 quemador Rápidos 3.000 W
Dimensiones (alto x ancho x fondo) (mm): **40 x 730 x 510**
Dimensiones encastre: **560 x 490 mm**

SMART

FHSM 604 4G DCL XS C
106.0554.391
7612985576789
461 €



Tipo: **Placa Gas**
Quemador: **Parrillas de fundición**
Válvulas de seguridad
Número de fuegos: **4**
Encendido: **Eléctrico**
Quemadores: **Planos de alta eficiencia**
1 quemador Auxiliar 1.000 W
2 quemadores Semirápidos 1.750 W
1 quemador Triple corona 3.500 W
Dimensiones (alto x ancho x fondo) (mm): **40 x 590 x 510**
Dimensiones encastre: **560 x 480 mm**

SMART

FHNL 705 4G TC XS E
106.0489.672
7612981898502
399 €



Tipo: **Placa Gas**
Quemador: **Parrillas esmaltadas**
Válvulas de seguridad
Número de fuegos: **5**
Encendido: **Eléctrico**
Quemadores: **Planos de alta eficiencia**
1 quemador Auxiliar 1.000 W
2 quemadores Semirápidos 1.750 W
1 quemador Rápido 3.000 W
1 quemador Wok triple llama 3.800 W
Dimensiones (alto x ancho x fondo) (mm): **55 x 680 x 510**
Dimensiones encastre: **560 x 490 mm**

SMART

FHNL 604 4G XS E
106.0489.620
7612981898472
265 €

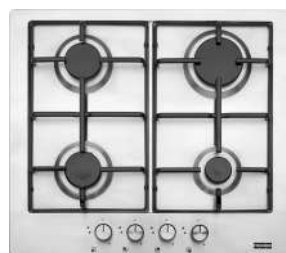

Tipo: **Placa Gas**
Quemador: **Parrillas esmaltadas**
Válvulas de seguridad
Número de fuegos: **4**
Encendido: **Eléctrico**
Quemadores: **Planos de alta eficiencia**
1 quemador Auxiliar 1.000 W
2 quemadores Semirápidos 1.750 W
1 quemador Rápido 3.000 W
Dimensiones (alto x ancho x fondo) (mm): **55 x 580 x 510**
Dimensiones encastre: **560 x 490 mm**

Cubetas

Fregaderos

Grifos

Campanas

Electrodomésticos

Gestión de residuos

Accesorios

Cubetas



Fregaderos

Grifos

Campanas

Electrodomésticos

Gestión de residuos

Accesorios

Lava vajillas

- 298 Lavavajillas integrables de 60
- 299 Lavavajillas integrables de 45





Cubetas

Fregaderos

Grifos

Campanas

Electrodomésticos

Gestión de residuos

Accesorios

MYTHOS



FDW 614 D10P DOS LP C
117.0611.675
 7612985814164
1.385 €

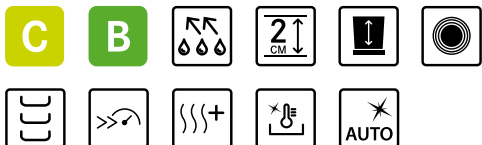

Tipo: **Lavavajilla Integrable 60 cm ancho**
 Zócalo: **2 cm**
 Clase eficiencia energética (NEL): **C**
 Clase eficiencia sonora: **B**
 Nivel sonoro (dBA): **41**
 Comandos: **Electrónicos con display digital**
 Número de cuebiertos: **14**
 Número de programas: **10**
 Programas: **Programa de lavado automático, Eco 50, Lavado y secado rápido, Cristal, Intensivo 65°, Pre lavado, Rápido 30', Desinfección, Programa autolimpieza de la cuba, Silencioso**
 Inicio diferido: **12h**
 Opción media carga: **Multizone**
 Bandejas: **3** / Seguridad: **Aquastop**
 Door Opening System: **Sí**
 Funcionamiento: **Luz en el suelo**
 Dimensiones (alto x ancho x fondo) (mm): **820 x 598 x 555**

MYTHOS



FDW 614 D10P DOS C
117.0611.674
 7612985814157
1.189 €



Tipo: **Lavavajilla Integrable 60 cm ancho**
 Clase eficiencia energética (NEL): **C**
 Clase eficiencia sonora: **B**
 Nivel sonoro (dBA): **41**
 Comandos: **Electrónicos con display digital**
 Número de cuebiertos: **14**
 Número de programas: **10**
 Programas: **Programa de lavado automático, Eco 50, Lavado y secado rápido, Cristal, Intensivo 65°, Pre lavado, Rápido 30', Desinfección, Programa autolimpieza de la cuba, Silencioso**
 Inicio diferido: **12h**
 Opción media carga: **Multizone**
 Bandejas: **2** / Seguridad: **Aquastop**
 Door Opening System: **Sí**
 Funcionamiento: **Luz en el suelo**
 Dimensiones (alto x ancho x fondo) (mm): **820 x 598 x 555**

MARIS



FDW 614 D7P DOS D
117.0611.673
 7612985814140
1.073 €

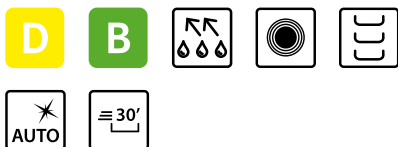

Tipo: **Lavavajilla Integrable 60 cm ancho**
 Clase eficiencia energética (NEL): **D**
 Clase eficiencia sonora: **B**
 Nivel sonoro (dBA): **43**
 Comandos: **Electrónicos con display digital**
 Número de cuebiertos: **14**
 Número de programas: **8**
 Programas: **Programa de lavado automático, Eco 50, Lavado y secado rápido, Cristal, Intensivo 65°, Pre lavado, Rápido 30', Silencioso**
 Inicio diferido: **12h**
 Opción media carga: **Multizone**
 Bandejas: **3** / Seguridad: **Aquastop**
 Door Opening System: **Sí**
 Funcionamiento: **Luz en el suelo**
 Dimensiones (alto x ancho x fondo) (mm): **820 x 598 x 555**

SMART



FDW 613 E5P F
117.0611.672
7612985814133
727 €



Tipo: **Lavavajilla Integrable 60 cm ancho**
Clase eficiencia energética (NEL): **F**
Clase eficiencia sonora: **C**
Nivel sonoro (dBA): **49**
Comandos: **Electrónicos con display digital**
Número de cuebiertos: **13**
Número de programas: **5**
Programas: **Eco 50, Intensivo 65°, Mixto, Rápido 30', Media carga**
Inicio diferido: **No**
Opción media carga: **Si**
Bandejas: **2** / Seguridad: **Overflow**
Door Opening System: **No**
Dimensiones (alto x ancho x fondo) (mm): **820 x 598 x 555**

Cubetas

Fregaderos

Ancho de 45 cm

SMART



FDW 4510 E8P E
117.0616.305
7612985842488
750 €



Tipo: **Lavavajilla Integrable 45 cm ancho**
Clase eficiencia energética (NEL): **E**
Clase eficiencia sonora: **C**
Nivel sonoro (dBA): **47**
Comandos: **Electrónicos con display digital**
Número de cuebiertos: **10**
Número de programas: **8**
Programas: **Eco 50, Cristal, Auto Intensivo 65°, Auto Mixto, Prelavado, Rápido 30', Desinfección, Silencioso**
Inicio diferido: **12h**
Opción media carga: **Multizone**
Bandejas: **3** / Seguridad: **Aquastop**
Door Opening System: **No**
Aviso acústico fin de ciclo
Dimensiones (alto x ancho x fondo) (mm): **820 x 448 x 555**

Grifos

Campanas

Electrodomésticos

Gestión de residuos

Accesorios

Cubetas

Fregaderos

Grifos

Campanas

Electrodomésticos

Gestión de residuos

Accesorios





Frigoríficos

- 304 Frigoríficos integrables
- 307 Frigoríficos libre instalación
- 307 Side by side integrables
- 308 Vinotecas

Cubetas

Fregaderos

Girfos

Campanas

Electrodomésticos

Gestión de residuos

Accesorios

Frío

Frigoríficos Combi Integrables

Frigoríficos Combi Integrables Side by side

MYTHOS



FCB 400 V NE
p. 305



FCB 360 TNF NEE
p. 305



FCB 360 V NEE
p. 305



FSDF 330 NF NE F
p. 307

+



FSDR 330 V NE F
p. 307

MARIS



FCB 320 TNF NE F
p. 306



FCB 320 V NEE
p. 306

SMART



FCB 320 NE F
p. 306

Frigoríficos Combi Libre Instalación



FCB 340 NF XS
p. 307

Vinotecas



FMY 24 WCR XS / BK
p. 309

Cubetas

Fregaderos

Girifos

Campanas

Electrodomésticos

Gestión de residuos

Accesorios

Frigoríficos, congeladores y combinados



MYTHOS



FCB 400 V NE
118.0629.526
7612985917025
2.328 €



Tipo: **Frigorífico Combi Integrable**

Clase energética: **E**

Eficiencia sonora: **B**

Capacidad: **400 L (Congelador: 101 L / Frigorífico: 299 L)**

Capacidad extra: **+45%***

Mandos: **Display táctil en la parte superior**

No Frost: **No**

Funciones: **EasyFrost; Función Fast Cooling (Enfriamiento rápido); Función Fast Freezing (Congelación rápida); Modo vacaciones; Stand by del aparato**

Puerta: **Deslizante y reversible**

Equipamiento: **Cajón FreshZone; Compartimento 0°C; 5 estantes en el frigorífico, botellero en silver, 1 cajón en el frigorífico, 4 balcones ajustables, huevera, 3 cajones en el congelador, cubitera de hielo**

Seguridad: **Alarma puerta abierta**

Dimensiones (alto x ancho x fondo): **1935 x 690 x 545 mm**

Dimensiones nicho: **1940 x 710 x 560 mm**

Cubetas

Fregaderos

MYTHOS



FCB 360 TNF NE E
118.0656.684
7612986088304
1.651 €



Tipo: **Frigorífico Combi Integrable**

Clase energética: **E**

Eficiencia sonora: **B**

Capacidad: **280 L (Congelador: 68 L / Frigorífico: 212 L)**

Capacidad extra: **+15%***

Mandos: **Display táctil en la parte superior**

No Frost: **Total No Frost**

Función: **Fast Freezing (Congelación rápida); Función Stand by del aparato, menor consumo de energía**

Cierre puerta: **Puerta deslizante y reversible**

Equipamiento: **Columna Multiflow; Cajón FreshZone; 5 estantes en el frigorífico, botellero, 1 cajón en el frigorífico, 4 balcones ajustables, huevera, 2 cajones en el congelador, 1 compartimento en el congelador, cubitera de hielo**

Seguridad: **Alarma puerta abierta**

Dimensiones (alto x ancho x fondo): **1935 x 540 x 545 mm**

Dimensiones nicho: **1940 x 560 x 560 mm**

Grifos

Campanas

MYTHOS



FCB 360 V NE E
118.0606.723
7612985787819
1.558 €



Tipo: **Frigorífico Combi Integrable**

Clase energética: **E**

Eficiencia sonora: **B**

Capacidad: **306 L (Congelador: 79 L / Frigorífico: 227 L)**

Capacidad extra: **+15%***

Mandos: **Display táctil en la parte superior**

No Frost: **EasyFrost**

Funciones: **Función Fast Cooling (Enfriamiento rápido); Función Stand by del aparato, menor consumo de energía**

Cierre puerta: **Puerta deslizante y reversible**

Equipamiento: **Cajón FreshZone; 3 estantes de cristal en el frigorífico, botellero, 1 cajón en el frigorífico, 4 balcones ajustables, huevera, 2 cajones en el congelador, 1 compartimento en el congelador, cubitera de hielo**

Seguridad: **Alarma puerta abierta**

Dimensiones (alto x ancho x fondo): **1935 x 540 x 545 mm**

Dimensiones nicho: **1940 x 560 x 560 mm**

Electrodomésticos

Gestión de residuos

Accesorios

*comparado con un frigorífico estándar de 177 cm de altura

Colección 2023 **305**

MARIS



FCB 320 TNF NE F
118.0656.683
7612986087895
1.558 €



Tipo: **Frigorífico Combi Integrable**
Clase energética: **F**
Eficiencia sonora: **B**
Capacidad: **250 L (Congelador: 68 L / Frigorífico: 182 L)**
Mandos: **Display táctil en la parte superior**
No Frost: **Total No Frost**
Funciones: **Función Fast Freezing (Congelación rápida); Función Stand by del aparato, menor consumo de energía**
Cierre puerta: **Puerta deslizante y reversible**
Equipamiento: **Columna Multiflow; Cajón FreshZone; 4 estantes en el frigorífico, botellero, 1 cajón en el frigorífico, 3 balcones ajustables, huevera, 2 cajones en el congelador, 1 compartimento en el congelador, cubitera de hielo**
Seguridad: **Alarma puerta abierta**
Dimensiones (alto x ancho x fondo): **1770 x 540 x 545 mm**
Dimensiones nicho: **1776 x 560 x 560 mm**

MARIS



FCB 320 V NE E
118.0606.722
7612985787802
1.327 €



Tipo: **Frigorífico Combi Integrable**
Clase energética: **E**
Eficiencia sonora: **B**
Capacidad: **273 L (Congelador: 79 L / Frigorífico: 194 L)**
Mandos: **Electrónicos**
No Frost: **Easy Frost**
Funciones: **Función Stand by del aparato, menor consumo de energía**
Cierre puerta: **Puerta deslizante y reversible**
Equipamiento: **Cajón FreshZone; 4 estantes en el frigorífico, botellero en silver, 1 cajón en el frigorífico, 3 balcones ajustables, huevera, 2 cajones en el congelador, 1 compartimento en el congelador, cubitera de hielo**
Seguridad: **Alarma puerta abierta**
Dimensiones (alto x ancho x fondo): **1770 x 540 x 545 mm**
Dimensiones nicho: **1776 x 560 x 560 mm**

SMART



FCB 320 NE F
118.0606.721
7612985786898
1.038 €



Tipo: **Frigorífico Combi Integrable**
Clase energética: **F**
Eficiencia sonora: **B**
Capacidad: **273 L (Congelador: 79 L / Frigorífico: 194 L)**
No Frost: **Easy Frost**
Funciones: **Función Stand by del aparato, menor consumo de energía**
Cierre puerta: **Puerta deslizante y reversible**
Equipamiento: **Columna Multiflow; Cajón FreshZone; 5 estantes en el frigorífico, 1 cajón en el frigorífico, 3 balcones ajustables, huevera, 2 cajones en el congelador, 1 compartimento en el congelador, cubitera de hielo**
Seguridad: **Alarma puerta abierta**
Dimensiones (alto x ancho x fondo): **1770 x 540 x 545 mm**
Dimensiones nicho: **1774 x 560 x 555 mm**

MYTHOS



Combinable con frigorífico
FSDF 330 V NE F

FSDF 330 NF NE F
118.0627.482
7612985907231
1.408 €



Tipo: **Congelador integrable**

Clase energética: **F**

Eficiencia sonora: **C**

Capacidad: **209 L**

Mandos: **Display Táctil**

No Frost: **Sí**

Funciones: **ECO; Best; Fast Freezing (Congelación rápida)**

Puerta: **Deslizante y reversible; apertura de la puerta hacia la izquierda**

Cajones: **7 + 1 cubitera**

Seguridad: **Alarma de corte de luz**

Dimensiones (alto x ancho x fondo): **1770 x 540 x 545 mm**

Dimensiones nicho: **1774 x 560 x 555 mm**

MYTHOS



Combinable con congelador
FSDF 330 NF NE F

FSDR 330 V NE F
118.0627.481
7612985907224
1.223 €

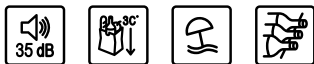

Tipo: **Frigorífico integrable**

Clase energética: **F**

Eficiencia sonora: **B**

Capacidad: **314 L**

Mandos: **Display Táctil**

Funciones: **Fast Cooling; Stand by del aparato; Modo vacaciones**

Puerta: **Deslizante y reversible; apertura de la puerta hacia la derecha**

Equipamiento: **5 estantes, 3 estantes ajustables en el**

frigorífico, botellero en silver, 2 cajones en el frigorífico, 5 balcones ajustables, 1 x 6 huevera

Seguridad: **Alarma puerta abierta**

Dimensiones (alto x ancho x fondo): **1770 x 540 x 545 mm**

Dimensiones nicho: **1774 x 560 x 555 mm**

SMART



FCB 340. NF XS*
118.0635.721
7612985943956
1.223 €



Tipo: **Frigorífico combi libre instalación**

Clase energética: **E**

Eficiencia sonora: **C**

Capacidad: **331 L (Congelador: 101 L / Frigorífico: 230 L)**

Mandos: **Display LED en la puerta**

No Frost: **Multicooling**

Funciones: **Función Fast Freezing (Congelación rápida); Modo vacaciones**

Puerta: **Reversible**

Equipamiento: **Compartimento 0°C; Columna Multiflow;**

5 estantes en el frigorífico, botellero en silver, 2 cajones en el frigorífico, 3 balcones ajustables, huevera, 3

cajones en el congelador, cubitera de hielo

Seguridad: **Alarma puerta abierta**

Dimensiones (alto x ancho x fondo): **1860 x 595 x 650 mm**

* Disponible hasta agotar existencias

Colección 2023 **307**

Cubetas

Fregaderos

Grifos

Campanas

Electrodomésticos

Gestión de residuos

Accesorios

Vinotecas



MYTHOS



FMY 24 WCR XS
131.0669.345
7612986168631
2.309 €



Tipo: **Vinoteca Integrable 45 cm**

Clase energética: **G**

Capacidad: **66 L**

Capacidad de botellas: **24**

Mandos: **Display LED blanco**

Temperatura regulable de +4 °C a +18°C

Cierre puerta: **Apertura de la puerta lateral Push-Push**

Cristal anti UV

Equipamiento: **3 estantes de madera (roble) extraíble**

Dimensiones (alto x ancho x fondo): **455 x 588 x 555 mm**

Nivel sonoro (dB): **42**

Cubetas

Fregaderos

Girifos

MYTHOS



FMY 24 WCR BK
131.0690.488
7612986276268
2.309 €



Tipo: **Vinoteca Integrable 45 cm**

Clase energética: **G**

Capacidad: **66 L**

Capacidad de botellas: **24**

Mandos: **Display LED blanco**

Temperatura regulable de +4 °C a +18°C

Cierre puerta: **Apertura de la puerta lateral Push-Push**

Cristal anti UV

Equipamiento: **3 estantes de madera (roble) extraíble**

Dimensiones (alto x ancho x fondo): **455 x 588 x 555 mm**

Nivel sonoro (dB): **42**

Campanas

Electrodomésticos

Gestión de residuos

Accesorios

Pictogramas



Hornos

	Pirolítico		Grill		Precalear		Full Menu
	Hidrolítico		Turbo Grill		Pizza		Guías telescópicas
	Convencional		Maxi Cooking		Pan automático		Smooth2close: cierre de puerta suave
	Cocción superior		Ventilador asistencia inferior		Pan		Press to clean: fácil limpieza de cristal
	Cocción inferior		Descongelar		Patelería Automático		Eco Hot Air
	Cocción ventilada		Aire forzado vapor		Quick Cooking		Mantener caliente
	Aire forzado Eco		Cookassist		Fermentar		Capacidad
	Aire forzado		Multicooking		Vapor		

Microondas











	Descongelar Automático		Aire Forzado combinado		Vapor		Microondas
	Aire forzado Automático		Grill combinado		Grill		Full Menu
	Recalentar Automático		Turbo Grill combinado		Precalear		Capacidad



Placas

-  Flex Pro: 8 zonas de cocción cacerolas Ø 10 -40 cm
-  Baño maría / Derretir
-  Grill / Gratinar
-  Zona puente
-  Easy Cook: Funciones de cocción preprogramadas
-  Fuego lento / Pochar
-  Mantener caliente
-  Válvula de seguridad
-  Pro Cook: Aprovechamiento de niveles de potencia con movilidad utensilios
-  Hervir
-  Función uso cafetera Moka
-  Encendido electrónico
-  Añadir Olla
-  Saltear / Freír
-  Temporizador
-  Hierro fundido

Lavavajillas

-  Door Opening System
-  Extradry
-  Autolimpieza del filtro
-  Puerta deslizante
-  Multizone
-  Programa desinfección
-  Rápido 30
-  Luz en el suelo
-  Media carga
-  Turbo
-  Zócalo de 2 cm

Frío













-  No-Frost
-  Multiflow
-  Super cool
-  Control de humedad
-  Fast freeze
-  Vacaciones
-  Ionizer
-  Botellero
-  Easy Frost
-  Compartimento 0°C
-  Filtro de carbón activo
-  Decibelios
-  Eco

Tabla de eficiencia energética

para Lavavajillas y Frío

Antes		A+++	A++	A+	A	B	C	D	E
Ahora	A	B	C			D	E	F	G

*Equivalencia aproximada entre etiquetas de eficiencia energética antiguas y las nuevas regladas por la Unión Europea.



Gestión de residuos

- 314 Para mueble de 60cm
- 317 Para mueble de 50cm
- 318 Para mueble de 45 cm
- 319 Para mueble de 40 cm
- 320 Soluciones para puerta con bisagra
- 321 Soluciones a ras/sobre encimera



Para muebles de 60cm

MYTHOS

Sistema: **modular de cubos**Cierre: **Softclose (cierre suave)**Almacenamiento tapa: **Para detergentes y utensilios de limpieza.**Armario de soporte: **600 mm**Contenedores: **1 x 26 litros | 2 x 11 litros**Filtro: **Carbón anti olor**Cubo: **Asas, Cubre Asas**Instalación: **Sistema montaje extraíble, guías laterales en pared**Dimensiones (alto x ancho x fondo): **448 x 600 x 506 mm**

SORTER FX 60 26-11-11

121.0557.763

7612985607742

380 €

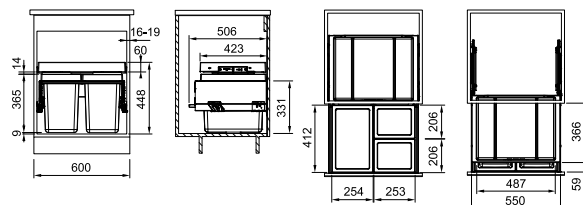
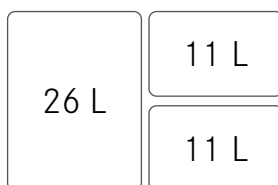

MYTHOS

Sistema: **modular de cubos**Cierre: **Softclose (cierre suave)**Almacenamiento tapa: **Para detergentes y utensilios de limpieza.**Armario de soporte: **600 mm**Contenedores: **2 x 26 litros**Filtro: **Carbón anti olor**Cubo: **Asas, Cubre Asas**Instalación: **Sistema montaje extraíble, guías laterales en pared**Dimensiones (alto x ancho x fondo): **448 x 600 x 506 mm**

SORTER FX 60 26-26

121.0557.764

7612985607759

369 €

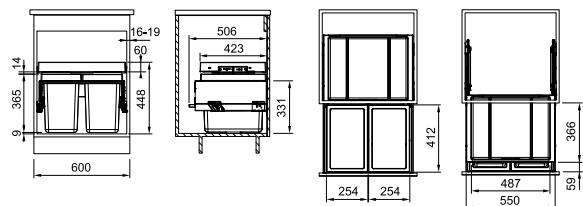

Para muebles de 60cm

MYTHOS



Sistema: **modular de cubos**
 Cierre: **Softclose (cierre suave)**
 Almacenamiento tapa: **Para detergentes y utensilios de limpieza.**
 Armario de soporte: **600 mm**
 Contenedores: **1 x 35 litros | 1 x 16 litros**
 Filtro: **Carbón anti olor**
 Cubo: **Asas, Cubre Asas**
 Instalación: **Sistema montaje extraíble, guías laterales en pared**
 Dimensiones (alto x ancho x fondo): **448 x 600 x 456 mm**

SORTER FX 60 35-16
121.0557.765
 7612985607766
345 €

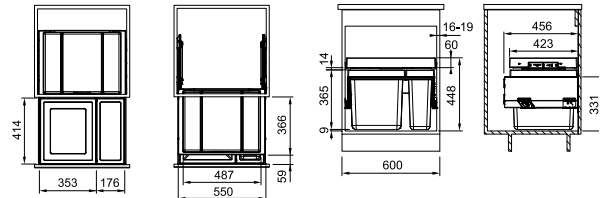
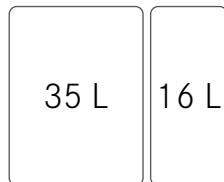
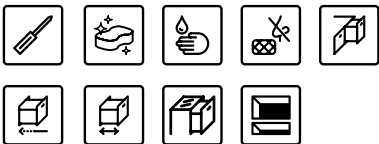

MARIS



174

175

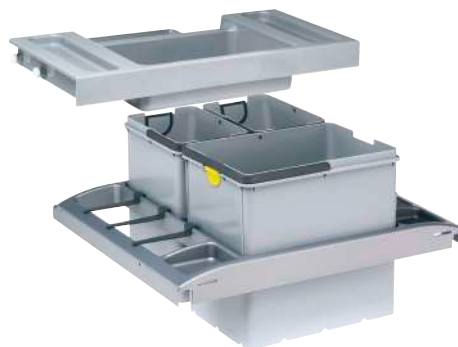

Sistema: **modular de cubos**
 Almacenamiento: **Espacios laterales para botellas, periódicos o útiles para limpieza.**
 Armario de soporte: **600 mm**
 Contenedores: **1 x 18 litros | 2 x 8 litros**
 Cubo: **Asas en cada cubo**
 Instalación: **Sistema montaje extraíble, para ser ensamblados sobre un cajón (guías, cajón y puertamueble no incluidos)**
Bandeja / Tapa con guías (incluido)
 Dimensiones (alto x ancho x fondo): **390 x 560 x 483 mm**

TROLLEY 2 VARIO 60
134.0066.057
 7612980052837
122 €

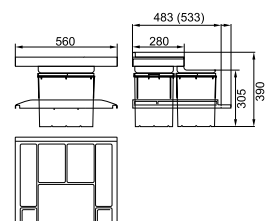
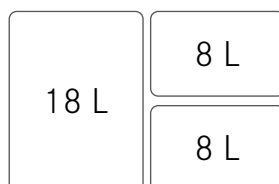

Cubetas

Fregaderos

Grifos

Campanas

Electrodomésticos

Gestión de residuos

Accesorios

Para muebles de 60cm

MARIS

176

180

**SORTER GARBO 60-4**

121.0200.676

7612980657490

265 €



8 L	8 L
12 L	12 L

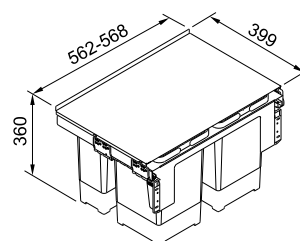

Sistema de suspensión anclado a la puerta y deslizamiento suave

Cierre: **mecanismo de cierre automático amortiguado**

Tapa conjunto: **Metal estable con espacio de almacenamiento**

Montaje: **Fácil de montar atornillado a la pared y a la puerta**

Apertura: **Es necesario tirador en la puerta**

Armario de soporte: **600 mm**

Contenedores: **2 x 12 Litros | 2 x 8 Litros**

Asas: **en cada cubo**

Instalación: **sistema montaje extraíble. Incluye bandeja/**

tapa adaptador para muebles de 16 x 19 mm de grosor

Dimensiones (alto x ancho x fondo): **360 x 562 x 399 mm**

Altura reducida, ideal para muebles de fregaderos

MARIS

176

178

179

180

181

**SORTER GARBO 60-3**

121.0200.680

7612980657506

253 €



12 L	Residuos orgánicos
18 L	8 L

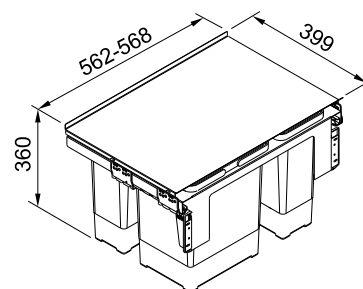

Sistema de suspensión anclado a la puerta y deslizamiento suave

Cierre: **mecanismo de cierre automático amortiguado**

Tapa conjunto: **Metal estable con espacio de almacenamiento**

Montaje: **Fácil de montar atornillado a la pared y a la puerta**

Apertura: **Es necesario tirador en la puerta**

Armario de soporte: **600 mm**

Contenedores: **1 x 18 Litros | 1 x 12 Litros | 1 x 8 Litros |**

Contenedor residuos orgánicos

Asas: **en cada cubo**

Instalación: **sistema montaje extraíble.**

Dimensiones (alto x ancho x fondo): **360 x 562 x 399 mm**

Altura reducida, ideal para muebles de fregaderos

Para muebles de 60cm

MARIS



179

181



SORTER GARBO 60-2

121.0284.027

7612981049423

249 €

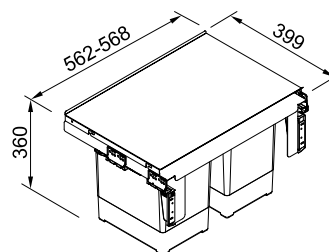

Sistema de suspensión anclado a la puerta y deslizamiento suave

Cierre: **mecanismo de cierre automático amortiguado**
Tapa conjunto: **Metal estable con espacio de almacenamiento**

Montaje: **Fácil de montar atornillado a la pared y a la puerta**

Apertura: **Es necesario tirador en la puerta**

Armario de soporte: **600 mm**

Contenedores: **2 x 18 Litros**

Asas: **en cada cubo**

Instalación: **sistema montaje extraíble.**

Dimensiones (alto x ancho x fondo): **360 x 562 x 399 mm**

Altura reducida, ideal para muebles de fregaderos

Para muebles de 50cm

MARIS



182

175

185



CUBE 50/2 AUTOMÁTICO

134.0055.292

7612980038183

184 €

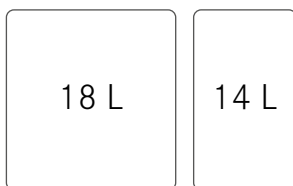

Armario de soporte: **500 mm**

Contenedores: **1 x 14 Litros | 1 x 18 Litros**

Tapa del conjunto

Filtro: **carbón anti olor**

Asas: **en cada cubo**

Instalación: **sistema montaje inferior**

Dimensiones (alto x ancho x fondo): **345 x 438 x 330 mm**

Instalación en mueble de 50 cm

Bisagras del mueble: **mínimo de 90°**

Apertura: **manual**

Total ancho: **438 mm**

Únicamente con grosor de pared de mueble de 16 mm

Instalación en mueble de 60 cm

Bisagras del mueble: **110°**

Apertura: **Automática con brazo fijado a la puerta del mueble**

Total ancho: **515 mm**

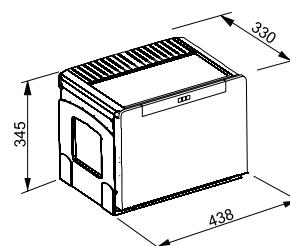

Para muebles de 45 cm

MARIS



179

181



SORTER GARBO 45-2
121.0200.692
7612980660421
249 €



12 L

18 L

Sistema de suspensión anclado a la puerta y deslizamiento suave

Cierre: **mecanismo de cierre automático amortiguado**
Tapa conjunto: **Metal estable con espacio de almacenamiento**

Montaje: **Atornillado a la pared y a la puerta**

Apertura: **Es necesario tirador en la puerta**

Armario de soporte: **450 mm**

Contenedores: **1 x 18 Litros | 1 x 12 Litros (tapa incluida)**

Asas: **en cada cubo**

Instalación: **sistema montaje extraíble.**

Dimensiones (alto x ancho x fondo): **360 x 412 x 399 mm**

Altura reducida, ideal para muebles de fregaderos

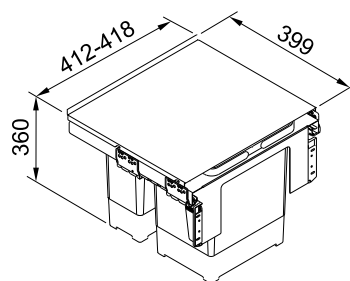

Para muebles de 40 cm

MARIS



182

184

185



CUBE 40/3C
134.0039.331
7612980015610
172 €



7 L

7 L

14 L

Sistema premontado

Cierre: **mecanismo de cierre automático amortiguado**
Tapa conjunto: **Plástico resistente con espacio de almacenamiento**

Montaje: **Atornillado a la pared y a la puerta (ver página siguiente consejo de montaje en mueble de 45 y 40 cm)**

Apertura: **Es necesario tirador en la puerta**

Armario de soporte: **400 mm**

Contenedores: **1 x 14 Litros | 1 x 7 Litros**

Asas: **en cada cubo**

Instalación: **sistema de montaje inferior**

Dimensiones (alto x ancho x fondo): **348 x 407 x 335 mm**

Altura reducida, ideal para muebles de fregaderos

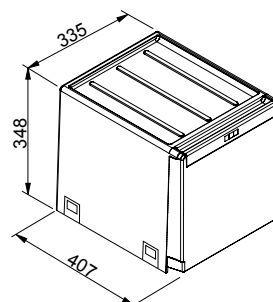

Para muebles de 40 cm

MARIS



175

185



CUBE 40/2C
134.0039.332
7612980015627
168 €



14 L

14 L

Sistema premontado

Tapa conjunto: **Plástico resistente con espacio de almacenamiento**

Montaje: **Atornillado a la pared y a la puerta**

Apertura: **Es necesario tirador en la puerta**

Armario de soporte: **400 mm**

Contenedores: **2 x 14 Litros**

Asas: **en cada cubo**

Instalación: **sistema de montaje inferior**

Dimensiones (alto x ancho x fondo): **348 x 407 x 335 mm**

Altura reducida, ideal para muebles de fregaderos

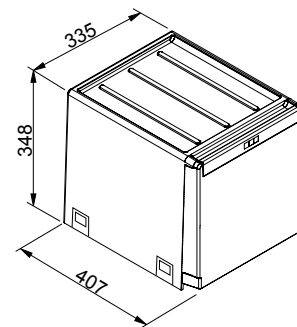

Instalación del CUBE 40 - 2C y 3C:

Instalación en mueble de 45

Bisagras del mueble: 110°
Apertura automática con brazo fijado a la puerta del mueble
Total ancho 402 mm

Instalación en mueble de 40

Bisagras del mueble: mínimo de 90°
Apertura manual (no hay espacio para el brazo de apertura automática)
Total ancho 335 mm

Soluciones Puerta con Bisagra - Mueble 40cm

SMART



SORTER PIVOT 400 V2 BK
121.0307.563
 7612981160135
138€



Cubo compacto de residuos orgánicos
 Fácil instalación
 Cubierta de plástico resistente con espacio de almacenamiento
 Compatible con todos los fregaderos Franke
 Bolsa de hasta 35 litros
 Para puertas a izquierda o derecha
 Material: **Plástico 100 % reciclable**
 Armario de soporte: **400 mm**
 Contenedor: **1 x 27 Litros**
 Tapa
 Filtro: **carbón anti olor**
 Instalación: **Puertas con bisagras**
 Dimensiones (alto x ancho x fondo): **419 x 358 x 341 mm**

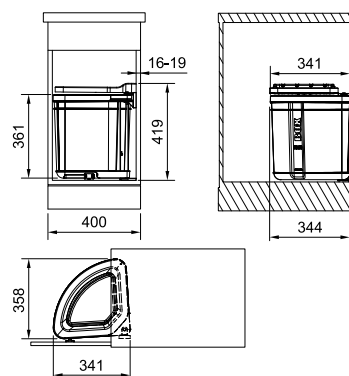

SMART



SORTER MINI
121.0176.518
 7612980515219
62 €



Cubo compacto de residuos orgánicos
 Fácil instalación
 Cubierta de plástico resistente con espacio de almacenamiento
 Compatible con todos los fregaderos Franke
 Para puertas a izquierda o derecha
 Material: **Plástico 100 % reciclable**
 Armario de soporte: **400 mm**
 Contenedor: **1 x 17 Litros**
 Tapa
 Instalación: **Puertas con bisagras**
 Dimensiones (alto x ancho x fondo): **348 x 310 x 290 mm**

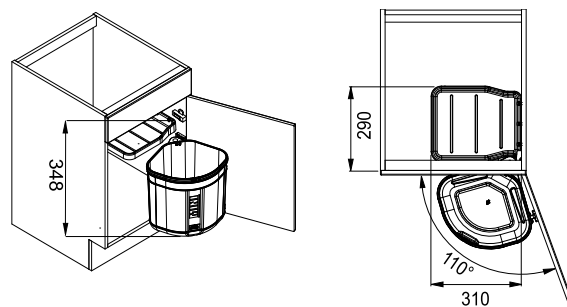

Soluciones A Ras / Sobre Encimera

MYTHOS



WASTE BIN FLUSH-M F12
134.0035.043
7612142230028
230 €

Sistema montaje: **a ras**
Armario de soporte: **300 mm**
Contenedores: **1 x 12 Litros**
Tapa de acero inoxidable
Asas

Dimensiones (alto x ancho x fondo): **315 x 282 x Ø 235 mm**

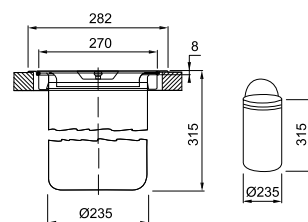

MYTHOS



WASTE BIN INSET M E12
134.0035.042
7612142230011
218 €

Sistema montaje: **sobre encimera**
Armario de soporte: **300 mm**
Contenedores: **1 x 12 Litros**
Tapa de acero inoxidable
Asas

Dimensiones (alto x ancho x fondo): **315 x 306 x Ø 235 mm**

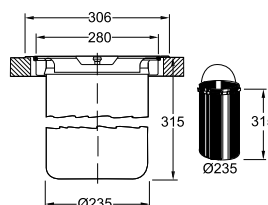

Cubetas

Fregaderos

Girifos

Campanas

Electrodomésticos

Gestión de residuos

Accesorios

Cubetas



Fregaderos

Grifos

Campanas

Electrodomésticos

Gestión de residuos

Accesorios

Acceso rios

324	All-In
327	Masterpiece
328	Andy chef
329	Accesorios
346	Productos de limpieza





Cubetas

Fregaderos

Grifos

Campanas

Electrodomésticos

Gestión de residuos

Accesorios

Todo se completa con **ALL IN**

La solución todo en uno para cortar, escurrir, lavar y guardar tus recetas.

All-In transforma cualquier fregadero en una elegante y divertida estación de trabajo.

All-In es el sistema flexible de preparación de alimentos diseñado para aportar más fluidez a tu cocina y a tu vida.



Ocho accesorios, infinidad de usos, se adapta a cualquier fregadero*



*Hasta 540mm



Prepara

Utilizando la tabla de bambú, las guías telescópicas, el colador y las cubetillas, All-In puede ayudarte:

- Picar verduras y otros ingredientes
- Recoger los alimentos cortados
- Recoger las pieles y ocuparse de los residuos
- Guardar los ingredientes preparados en el frigorífico



Cocina

Las guías, las cubetas escurridor y el escurridor de silicona son realmente útiles en la fase de cocción y puedes:

- Dejar las ollas y sartenes en las guías mientras se llenan de agua
- Utilizar el colador para escurrir la pasta u otros ingredientes
- Apoyar sartenes y platos calientes sobre el escurridor flexible para proteger las superficies de trabajo



Limpia

Cuando es tiempo de limpiar tu área de trabajo, las guías telescópicas, la cubetilla y el escurridor flexible, te puede ayudar a:

- Escurrir platos y vasos
- Escurrir los cubiertos y utensilios de cocina



Ordena

Una vez terminada la limpieza, All-In puede ayudarte a ordenar todo, ya sea para:

- Guardar los artículos de limpieza en el fregadero
- Mantener todos los accesorios juntos en la caja de almacenaje
- Guardarlo todo perfectamente organizado dentro de tus muebles de cocina

Cubetas

Fregaderos

Grifos

Campanas

Electrodomésticos

Gestión de residuos

Accesorios

Accesorios

Fregaderos All-In



11

ALL-IN GUIA-CUBETILLA-PLACA CORTE

Accesorios All -In
112.0655.481
7612986084603
138 €



14

ALL-IN GUIA-BOLx2-PLACA CORTE-ESCU

Accesorios All -In
112.0655.488
7612986084641
207 €

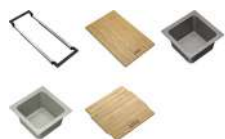

12

ALL-IN GUIA-BOLx2-PLACA DE CORTE

Accesorios All -In
112.0655.482
7612986084610
161 €

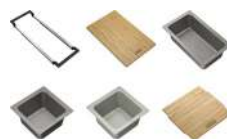

15

ALL IN FULL SET CON CAJA ALMACENAJE

Accesorios All -In
112.0655.489
7612986084658
253 €



reddot winner 2022

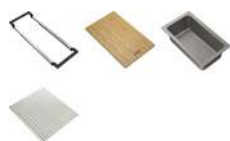

13

ALL-IN GUIA-CUBETILLA- PLACA CORTE-ESCU

Accesorios All -In
112.0655.483
7612986084627
195 €



Beneficios All-In

Accesorios Masterpiece



01

REJILLA SOPORTE ANTRACITA 40
 Accesorio Masterpiece
 112.0655.431
 49 €

NEW



09

REJILLA SOPORTE ORO 68
 Accesorio Masterpiece
 112.0655.409
 79 €

NEW



02

REJILLA SOPORTE ANTRACITA 50
 Accesorio Masterpiece
 112.0655.470
 59 €

NEW



10

REJILLA HPL ANTRACITA
 405x674x35mm
 Accesorio Masterpiece
 112.0676.895
 499 €

NEW

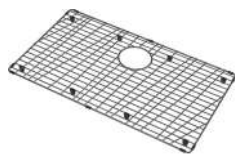

03

REJILLA SOPORTE ANTRACITA 68
 Accesorio Masterpiece
 112.0655.408
 79 €

NEW



204

VALVULA MANUAL PREMIUM
 INOX ORO
 Accesorio Masterpiece
 112.0652.898
 149 €

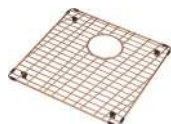

04

REJILLA SOPORTE COBRE 40
 Accesorio Masterpiece
 112.0655.468
 49 €

NEW



205

VALVULA MANUAL PREMIUM
 INOX COBRE
 Accesorio Masterpiece
 112.0652.978
 149 €



05

REJILLA SOPORTE COBRE 50
 Accesorio Masterpiece
 112.0655.472
 59 €

NEW



206

VALVULA MANUAL PREMIUM
 INOX ANTRACITA
 Accesorio Masterpiece
 112.0653.030
 149 €



06

REJILLA SOPORTE COBRE 68
 Accesorio Masterpiece
 112.0655.410
 79 €

NEW



207

VALVULA AUTO PREMIUM
 INOX ANTRACITA
 Accesorio Masterpiece
 112.0653.035
 199 €



07

REJILLA SOPORTE ORO 40
 Accesorio Masterpiece
 112.0655.433
 49 €

NEW



208

VALVULA AUTO PREMIUM
 INOX ORO
 Accesorio Masterpiece
 112.0653.036
 199 €



08

REJILLA SOPORTE ORO 50
 Accesorio Masterpiece
 112.0655.471
 59 €

NEW



209

VALVULA AUTO PREMIUM
 INOX COBRE
 Accesorio Masterpiece
 112.0653.041
 199 €

Cubetas

Fregaderos

Grifos

Campanas

Electrodomesticos

Gestión de residuos

Accesorios

Andy Chef Complemento Box



Beneficios Andy Chef



16

ANDY CHEF
 Accesorio Andy Chef
112.0619.946
 7612985856683
403 €



17

**CESTA-VAJILLA RECTANGULAR
INOX 901.630 (375 x 295 x 134 mm)**
Cesta vajilla rectangular
112.0156.214
7612318074685
45 €

Cubetillas y Escurridores



19

CUBETILLA INOX ANTRACITA
429 x156 x 53,5 mm (ext.)
Accesorio Masterpiece
112.0655.239
7612986083354
119 €

NEW



24

**CUBETILLA 412 x180 x 60 mm (ext.)
158,4 x 416 x 53,5 mm (int.)**
Cubetilla
112.0659.398
7612986099300
99 €



20

CUBETILLA INOX ORO
429 x156 x 53,5 mm (ext.)
Accesorio Masterpiece
112.0655.240
7612986083361
119 €

NEW



25

CUBETILLA 181x452x60
Cubetilla
112.0040.821
7612142221385
68 €



21

CUBETILLA INOX COBRE
429 x156 x 53,5 mm (ext.)
Accesorio Masterpiece
112.0655.341
7612986083378
119 €

NEW



26

CUBETILLA INOX BOX
429 x156,4 x 53,5 mm (ext.)
Cubetilla
112.0394.981
7612981698713
68 €



22

CUBETILLA INOX
156x417x54mm R12.5
Cubetilla
112.0066.060
7612980052851
122 €

NEW



27

CUBETILLA INOX MTX 172x412
Cubetilla
112.0057.850
7612980040674
48 €



23

CUBETILLA MRX TL 181x431mm
Cubetilla
112.0520.497
7612985441230
103 €

NEW



28

CUBETILLA MRX 317 x 177 x 60,8 mm
Cubetilla
112.0041.519
7612142236754
48 €



29

ESCURRIDOR GRIS URBAN
440x181x92mm
Escurridor
112.0538.950
7612985514781
23 €

Roll-Up

Cubetas

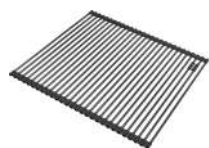

30

ROLL-UP ANTRACITA
440 x 468 mm
Accesorio Masterpiece
112.0655.342
149 €

NEW



35

ROLL-UP 468 x 440 mm
Escurreidor móvil
112.0080.355
7612980499175
91 €

Fregaderos



31

ROLL-UP ORO
440 x 468 mm
Accesorio Masterpiece
112.0655.343
149 €

NEW



36

ROLL-UP FRESNO 220 x 400mm
Escurreidor móvil
112.0520.938
7612985443463
91 €

Grifos



32

ROLL-UP COBRE
440 x 468 mm
Accesorio Masterpiece
112.0655.344
149 €

NEW



37

ROLL-UP 424 x 267 mm
Escurreidor enrollable
112.0591.081
7612985731454
76 €

Campanas



33

ESCURRIDOR MOVIL
298x412x17
Escurreidor móvil
112.0602.288
7612985772938
122 €



38

ROLL-UP 468 x 420 mm
Escurreidor enrollable
112.0030.882
7612142241574
80 €



34

ESCURRIDOR MOVIL KBK
342X430X22
Escurreidor móvil
112.0188.651
7612980584215
108 €



39

ROLL-UP 366 X 326 mm
Escurreidor enrollable
112.0075.642
7612980071180
57 €

Electrodomésticos



40

ROLL-UP 298 x 410mm
Escurreidor enrollable
112.0256.867
7612980897384
57 €

Gestión de residuos

121

KIT INSTALACION SIDE BY SIDE
Kit Instalación
133.0641.560
7612985974462
27 €

122

JUNTA UNION SIDE BY SIDE
133.0641.559
7612985974455
11 €

Accesorios

Accesorios Frigos

Tablas de Corte



41

TABLA DE CORTE MADERA
429x180x24 mm
Tabla de corte
112.0557.028
7612985603966
99 €



45

TABLA CORTE NEGRA
429x180x24 BOX CENTER
Tabla de corte
112.0539.120
7612985515245
91 €



42

TABLA DE CORTE
429 x180 x 24 BOX CENTER
Tabla de corte
112.0539.134
7612985515252
99 €



47

TABLA DE CORTE
BAMBÚ 280x532
Tabla de corte
112.0595.334
7612985746939
57 €



43

TABLA DE CORTE
278x434mm **CRISTAL NEGRO**
Tabla de corte
112.0355.965
7612981469344
99 €



48

TABLA DE CORTE
300x250mm **BLANCA**
Tabla de corte
112.0154.724
7612318269203
37 €



44

TABLA DE CORTE
412x180x13mm
Tabla de corte
112.0591.082
7612985731461
99 €



49

TABLA DE CORTE COLOR NUEZ
230X442X23 **KNG**
Tabla de corte
112.0654.748
7612986081176
80 €



50

SIFON SALVAESPACIO
1 VIA SALIDA 40mm
Sifón
112.0048.206
7612319502767
19 €



51

SIFON SALVAESPACIO
2 VIAS SALIDA 40mm
Sifón
112.0624.484
7612985884273
27 €



52

SIFON SALVAESPACIO
3 VIAS SF-3
Sifón
112.0156.212
7612318075194
28 €

Sifones

Conjuntos desagües colorline compatibles con fregaderos Fragranite

FUN	EAN	Descripción	FREGADEROS						
			MTG 611	MTG 651	MRG 651	MRG 611-62 MRG 611-78 MRG 611-78/49 MRG 611-97 MRG 611-97/49	CNG 611-62 TL CNG 611-78 TL	UBG 611	
112.0658.214	7612986094626	Cto. desagüe automático 1 Cubeta MB CNG/UBG/611/610						☐	☐
112.0658.446	7612986094923	Cto. desagüe automático 1 Cubeta MB MRG610							
112.0658.197	7612986094602	Cto. desagüe automático 1 Cubeta MB MTG/MRG611	☐				☐		
112.0658.124	7612986094640	Cto. desagüe automático 1 Cubeta MB UBG610-56							
112.0658.485	7612986099577	Cto. desagüe automático 2 CubetaS MB MRG620							
112.0658.280	7612986094701	Cto. desagüe automático 2 CubetaS MB MTG/MRG651		☐	☐				
112.0658.413	7612986094787	Cto. desagüe automático 2 CubetaS MB UBG620							
112.0658.242	7612986094619	Cto. desagüe manual 1 Cubeta MB CNG/UBG/611/610						☐	☐
112.0658.444	7612986094916	Cto. desagüe manual 1 Cubeta MB MRG610							
112.0657.946	7612986094398	Cto. desagüe manual 1 Cubeta MB MTG/MRG611	☐				☐		
112.0658.250	7612986094633	Cto. desagüe manual 1 Cubeta MB UBG610-56							
112.0658.484	7612986099836	Cto. desagüe manual 2 CubetaS MB MRG620							
112.0658.125	7612986094190	Cto. desagüe manual 2 CubetaS MB MTG/MRG651		☐	☐				
112.0658.438	7612986094770	Cto. desagüe manual 2 CubetaS MB UBG620							

CUBETAS					
MRG 610-72 MRG 610-52 MRG 610-37 MRG 610-72 TL MRG 610-52 TL MRG 610-37 TL	MRG 620-35-35	UBG 620	UBG 610-78	UBG 610-56	PVPR €
			☐		99
☐					99
					99
				☐	99
	☐				168
					168
		☐			168
			☐		87
☐					87
					87
				☐	87
	☐				145
					145
		☐			145

Válvulas y Cestillos

Cubetas

65

CTO VALV. AUTO 1 CUB.
MB CNG/UBG/611/610
Válvula
112.0658.214
7612986094626
99 €

72

CTO VALV. MANU 1 CUB.
MB CNG/UBG/611/610
Válvula
112.0658.242
7612986094619
87 €

Fregaderos



66

CTO VALV. AUTO 1 CUBETA
MB MRG610
Válvula
112.0658.446
7612986094923
99 €



73

CTO VALV. MANUAL 1 CUBETA
MB MRG610
Válvula
112.0658.444
7612986094916
87 €

Grifos

67

CTO VALV. AUTO 1 CUBETA
MB MTG/MRG611
Válvula
112.0658.197
7612986094602
99 €

74

CTO VALV. MANUAL 1 CUBETA
MB MTG/MRG611
Válvula
112.0657.946
7612986094398
87 €

Campanas

68

CTO VALV. AUTO 1
CUBETA MB UBG610-56
Válvula
112.0658.124
7612986094640
99 €

75

CTO VALV. MANUAL 1 CUBETA
MB UBG610-56
Válvula
112.0658.250
7612986094633
87 €



69

CTO VALV. AUTO 2 CUBETAS
MB MRG620
Válvula
112.0658.485
7612986099577
168 €



76

CTO VALV. MANUAL 2 CUBETAS
MB MRG620
Válvula
112.0658.484
7612986099836
145 €

Electrodomésticos

70

CTO VALV. AUTO 2 CUBETAS
MB MTG/MRG651
Válvula
112.0658.280
7612986094701
168 €

77

CTO VALV. MANUAL 2 CUBETAS
MB MTG/MRG651
Válvula
112.0658.125
7612986094190
145 €

Gestión de residuos

71

CTO VALV. AUTO 2 CUBETAS
MB UBG620
Válvula
112.0658.413
7612986094787
168 €

78

CTO VALV. MANUAL 2 CUBETAS
MB UBG620
Válvula
112.0658.438
7612986094770
145 €

Accesorios

Complementos Colorline



84

VALVULA MAN GREYL COLOR (NEGRO) S/REB)

Válvula
112.0668.276
7612986164923
58 €



85

VALVULA MAN GREYL COLOR (NEGRO)

Válvula
112.0657.022
7612986090598
56 €



101

VALVULA AUTO GREYL COLOR (NEGRO) 500mm

Válvula
112.0656.939
7612986090574
64 €



105

TAPA EMBELLECEDORA CIRCULAR MB D114

Tapón
112.0657.146
7612986091106
11 €



199

TAPON NEGRO MANUAL

Tapón
133.0657.023
7612986090765
19 €



106

REBOSADERO RECTANGULAR NEGRO MATE

Chapa Rebosadero
112.0657.273
7612986091007
28 €



107

REBOSADERO CIRCULAR NEGRO MATE

Chapa Rebosadero
112.0657.331
7612986091052
23 €



108

MANDO TWIST CONTROL NEGRO MATE

Mando Twist
112.0657.383
7612986091090
69 €



200

TAPON NEGRO AUTO

Tapón
133.0656.997
7612986090581
19 €

Cubetas

Fregaderos

Grifos

Campanas

Electrodomésticos

Gestión de residuos

Accesorios

Complementos Grey line

Cubetas



83

VALVULA MAN GREYLINE COLOR (SLIM)

Válvula
112.0604.234
7612985788502
25 €



82

VALVULA MAN GREYLINE COLOR (SLIM) S/REB

Válvula
112.0604.332
7612985788533
25 €

Fregaderos



63

VALVULA MAN GREYLINE INOX (SLIM)

Válvula
112.0332.276
7612981268756
26 €



81

VALVULA MAN GREYLINE INOX (SLIM) S/REB

Válvula
112.0332.277
7612981268763
21 €

Grifos



88

VALVULA AUTO GREYLINE COLOR (SLIM) 500mm

Válvula
112.0544.161
7612985534024
53 €



100

VALVULA AUTO GREYLINE INOX (SLIM) 500mm

Válvula
112.0332.278
7612981268770
41 €

Campanas



99

VALVULA AUTO GREYLINE INOX (SLIM) 700mm

Válvula
112.0564.134
7612985632416
46 €



98

VALVULA AUTO GREYLINE INOX 500mm S/REB

Válvula
112.0332.349
7612981268954
53 €

Electrodomésticos



97

VALVULA AUTO GREYLINE INOX 700mm S/REB

Válvula
112.0661.152
7612986107845
58 €



202

TAPON GREY LINE MANUAL

Tapón
133.0332.886
7612981279127
18 €

Gestión de residuos



201

TAPON GREY LINE AUTO

Tapón
133.0332.885
7612981279110
18 €

Accesorios

Complementos Premium

61



VALVULA MAN PREMIUM INOX
Válvula
112.0049.409
7612980027576
25 €

58



VALVULA MAN PREMIUM INOX SANITIZED
Válvula
112.0264.985
7612980952205
37 €

79



VALVULA MAN PREMIUM INOX S/REB
Válvula
112.0049.406
7612980027569
25 €

92



VALVULA AUTO PREM INOX 500mm
Válvula
112.0301.698
7612981128821
50 €

91



VALVULA AUTO PREM INOX 500mm S/REB
Válvula
112.0301.696
7612981128814
46 €

53



VALVULA AUTO PREM INOX 600mm
Válvula
112.0338.631
7612981307691
64 €

56



VALVULA AUTO PREM INOX 600mm SALVAESPACIO
Válvula
112.0173.076
7612980495122
53 €

90



VALVULA AUTO PREM INOX 700mm
Válvula
112.0307.018
7612981158309
67 €

89



VALVULA AUTO PREM INOX 700mm SALVAESPACIO
Válvula
112.0173.077
7612980495139
64 €

94



VALVULA AUTO PREM CERAM 500mm
Válvula
112.0331.953
7612981267513
53 €

93



VALVULA AUTO PREM COLOR 500mm
Válvula
112.0389.090
7612981667825
50 €

59



VALVULA MAN INTEGRADA PREMIUM INOX
Válvula
112.0049.415
7612980027590
41 €

55



VALVULA MAN INTEGRADA PREMIUM INOX SANITIZED
Válvula
112.0264.987
7612980952212
53 €

80



VALVULA MAN INTEGRADA PREMIUM INOX S/REB
Válvula
112.0049.411
7612980027583
46 €

Cubetas

Fregaderos

Grifos

Campanas

Electrodomésticos

Gestión de residuos

Accesorios

Válvulas y Cestillos

Cubetas

54



VALVULA AUTO INTEGRADA PREM INOX 500mm
Válvula
112.0301.673
7612981128746
53 €

57



VALVULA AUTO INTEGRADA PREM INOX 600mm SALVAESPACIO
Válvula
112.0173.079
7612980495153
53 €

Fregaderos

96



VALVULA AUTO INTEGRADA PREM INOX 700mm
Válvula
112.0307.020
7612981158415
58 €

95



VALVULA AUTO INTEGRADA PREM INOX 900mm
Válvula
112.0315.370
7612981195304
64 €

Grifos

116



TAPON VALVULA MAN PREMIUM
Tapón Válvula
133.0049.669
7612142248917
22 €

115



TAPON VALVULA AUTO PREMIUM
Tapón Válvula
133.0301.532
7612981128463
20 €

114



TAPON VALVULA AUTO PREMIUM INOX SALVAESP
Tapón Válvula
133.0049.668
7612142248900
20 €

Campanas

Electrodomésticos

112



REBOSADERO RECTANGULAR 97/117
Rebosadero
133.0050.083
7612980028672
19 €

111



REBOSADERO CIRCULAR 107/127 M6x14/25
Rebosadero
133.0459.871
7612981815714
26 €

Gestión de residuos

64



MANDO PUSH-KNOB ROUND INOX
Mando Push Knob
133.0391.835
7612981686987
68 €

110



MANDO TWIST CONTROL INOX
Mando Twist
133.0537.934
7612985511773
64 €

Accesorios

109



MANDO TWIST CONTROL INOX CERAM
Mando Twist
112.0598.082
7612985759083
64 €

Standard Inox Edition



62

VALVULA MANUAL (A) 2"
Válvula
112.0156.161
7612318192891
14 €



117

TAPON VALVULA MANUAL (A) 2" GOMA
Tapón Válvula
133.0156.191
7612318089115
11 €



60

VALVULA MANUAL (B) 3 1/2"
Válvula
112.0323.096
7612981237226
32 €



104

TAPON VALVULA MANUAL (B) INOX
Tapón
133.0156.169
7612318166274
18 €



87

VALVULA AUTOMATICA (C) 3 1/2"
Válvula
112.0156.167
7612318192914
58 €



103

TAPON VALVULA AUTOMATICA (C)/(D) INOX
Tapón
133.0156.168
7612318189266
18 €



86

VALVULA AUTOMATICA (D) 3 1/2" FREG INOX
Válvula
112.0156.158
7612318243128
64 €



113

REBOSADERO RE
Rebosadero
112.0154.731
7612318192976
12 €

Sets Fregaderos de Color



102

VALVULA AUTOMATICA (DG) 3 1/2" FR. COLOR
Válvula
112.0156.159
7612318243135
57 €



103

TAPON VALVULA AUTOMATICA (C)/(D) INOX
Tapón
133.0156.168
7612318189266
18 €

Otros Complementos



119

TAPON ORIFICIO GRIFERÍA INOX
Orificio Ø3,5 cm
112.0073.191
7612980499038
12 €



118

CTO FIJACION CUBETA BMG
Conjunto fijación
112.0441.856
7612981785437
18 €



120

REFUERZO ANTIPALANCA GRIFO
Refuerzo Antipalanca recomendado para grifos retráctiles instalados en fregaderos de acero
133.0026.896
7612142237942
38 €

Accesorios Campanas

Cubetas



123

CODO RECT A RECT 90G 220x90
Cod Rect a Rect
112.0459.451
7612981814779
23 €

168



SILENT TUBE MP-GO
Tubo decorativo
112.0281.490
7612981036454
47 €

Fregaderos



124

CODO RECT A RECT 90G 220x90
Cod Rect a Recta
112.0459.453
7612981814793
22 €

126



COLLARIN REDUCTOR D150-120 C-2462a
Collarín reductor
133.0016.959
8425622078855
21 €

Grifos



125

CODO PLANO RECT A RECT 90G 220x90
Codo plano rect a rect
112.0459.455
7612981815219
30 €

170



VALVULA ANTIRETORNO D.150 CAMPANA
Válvula antiretorno
133.0056.646
8425622085174
43 €

Campanas



149

JUNTA RECT A REDONDO 220x90
Junta rectangular
112.0459.429
7612981814755
24 €

171



VALVULA ANTIRETORNO (C/PLASTICO) D120
Válvula antiretorno
133.0056.177
8425622082104
33 €

Electrodomésticos



150

JUNTA RECTANGULAR 220x90
Junta rectangular
112.0459.428
7612981814748
19 €

127



CONTROL REMOTO
Control remoto
112.0657.298
7612986090116
63 €

Gestión de residuos



165

TUBO TR 1200 220x90
Tubo
112.0459.427
7612981814731
58 €

156

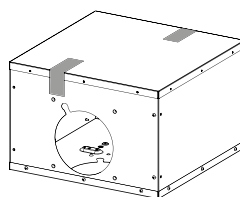

KIT INSTALACION MOTOR REMOTO ENERGY-PRO
Permite separar el motor de la campana
Kit Motor remoto
112.0327.007
7612981249564
230 €

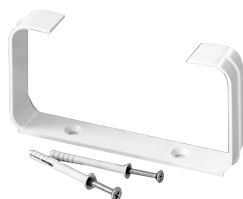

166

SOPORTE FIJACION 220X90
Soporte Fijación
112.0459.456
7612981815226
18 €

157

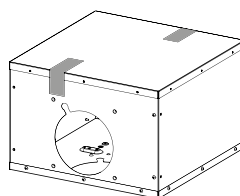

KIT INSTALACION MOTOR REMOTO MARIS
Permite separar el motor de la campana
Kit Motor remoto
112.0599.392
7612985764032
230 €

Accesorios



167

TUBO COARRUGADO SALIDA CAMPANA 150 TNM
Tubo Corrugado
112.0582.155
7612985696227
19 €

Accesorios Campanas



128

FILTRO CARBON (HP)
2 REDONDOS D19,6cm
 Filtro carbón
112.0174.995
 7612980506415
95 €



135

FILTRO CARBON (ST)
2 REDONDOS D.15cm
 Filtro carbón
112.0282.687
 7612981040499
30 €



129

FILTRO CARBON (ST)
2 UNIDADES ATMOS
 Filtro carbón
112.0542.064
 7612985525756
55 €



136

FILTRO CARBON (ST)
2 RED. D27/D35 V.2019
 Filtro carbón
112.0564.564
 7612985632478
18 €



130

FILTRO CARBON (ST)
2 RECT. 23x16 C/SOPOR
 Filtro carbón
112.0493.319
 7612981916169
54 €



137

FILTRO CARBON (HP)
METAL LAVABLE
 Filtro carbón high performance
112.0373.738
 7612981602055
91 €



131

FILTRO CARBON (ST)
RECTANGULAR 267x237
 Filtro carbón
112.0670.624
 7612986175455
45 €



138

FILTRO CARBON (LL+HP)
DOWN DRAFT
 Filtro carbón high performance
 y larga duración
112.0262.703
 7612980936083
156 €



132

FILTRO CARBON (ST)
2 REDONDOS D19,6cm
 Filtro carbón activo
112.0152.193
 8425622015461
42 €

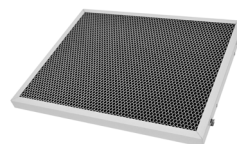

139

FILTRO CARBON (LL+HP)
REGENERANTE METAL
 Filtro carbón high performance
 y larga duración
112.0373.739
 7612981602062
80 €



133

FILTRO CARBON (ST)
2 DISCO D193
 Filtro carbón
112.0158.515
 7612980456901
32 €



140

FILTRO CARBON (LL+HP)
2 DISCO D193 (REG)
 Filtro carbón high performance
 y larga duración
112.0578.596
 7612985686068
67 €



134

FILTRO CARBON (ST)
RECTANGULAR 267x237
 Filtro carbón activo
112.0151.250
 8425622058628
30 €



141

FILTRO CARBON (LL)
H100 MYTHOS 2GETHER
 Filtro carbón larga duración
112.0548.448
 7612985546614
182 €

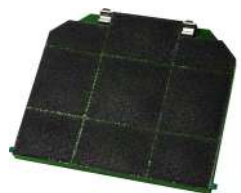

203

FILTRO DE CARBÓN (LL)
RECTANGULAR 267 X 237 MM
 Filtro de carbón
112.0174.992
 7612980506385
51 €



142

FILTRO CARBON (LL)
H60 MYTHOS 2GETHER
 Filtro carbón larga duración
112.0548.447
 7612985546607
155 €

Cubetas

Fregaderos

Grifos

Campanas

Electrodomésticos

Gestión de residuos

Accesorios

Accesorios Campanas

Cubetas



143

**FILTRO CARBON (LL)
DOWN DRAFT**
Filtro carbón larga duración
112.0289.753
7612981071523
133 €



146

**FILTRO CARBON (LL)
2 REDONDOS D19,6cm**
Filtro carbón larga duración
112.0492.115
7612981909161
77 €

Fregaderos



144

**FILTRO CARBON (LL)
4 RECTANGULAR 255x185**
Filtro carbón larga duración
112.0339.360
7612981310301
122 €



147

**FILTRO CARBON (LL+HP)
INFERIOR RECTANG.**
Filtro carbón larga duración
112.0356.226
7612981470005
61 €

Grifos



145

**FILTRO CARBON (LL)
RECTANGULAR 267x237**
Filtro carbón larga duración
112.0492.116
7612981909178
77 €



148

**FILTRO CARBON (LL)
2 RECT. 23x16 C/SOPOR**
Filtro carbón larga duración
112.0473.657
7612981833480
55 €

Campanas

Accesorios Campanas 2gether

Electrodomésticos



154

**KIT EXTRACCION ASP 2GETHER
ZOCALO 9cm**
Kit Extracción
112.0539.569
7612985516556
121 €



203

KIT RECIRCULACIÓN ZÓCALO 10CM
Kit recirculación
112.0678.323
7612986217537
434 €

Gestión de residuos



158

**KIT RECIRCULACION 10cm
MYTHOS 2GETHER**
Kit recirculación
112.0539.570
7612985516563
434 €



204

KIT RECIRCULACIÓN ZÓCALO 6CM
Kit recirculación
112.0678.324
76129855165a49
411 €

Accesorios



159

**KIT RECIRCULACION 6cm
MYTHOS 2GETHER**
Kit recirculación
112.0539.568
76129855165a49
411 €

Accesorios Campanas



152

KIT CHIMENEA MARIS NEGRA
50x30x20 (2uds)
Kit Chimenea
112.0285.288
7612981054236
99 €

153

KIT CHIMENEA CH 500/500 XS
FRK 300X200
Kit Chimenea
112.0197.447
7612980636921
85 €

160

PROLONGACIÓN CANAL TUBE
ISLA 990MM NEGRO
Prolongación canal
112.0604.855
7612985780285
445 €

161

PROLONGACIÓN CANAL TUBE
ISLA 990MM INOX
Prolongación canal
112.0049.382
7612980027552
422 €

193

PROLONGACIÓN DEL CANAL EN
BLANCO 990 MM
112.0615.789
7612985839907
445 €

162

PROLONGACION CANAL
ISLA 350X290X700 RECT
Prolongación canal
112.0017.991
7612319486340
318 €



163

PROLONGACION CANAL
PARED 300X260X990 REC
Prolongación canal
112.0017.983
7612319486289
110 €

164

PROLONGACION CANAL SWING/
QUADRA 990 x 300 x 200 mm
Prolongación canal
112.0036.204
7612980014927
85 €

195

KIT CHIMENEA EXT H2X400MM
NEGRA
Prolongación
112.0681.031
7612986229264
99 €

196

KIT CHIMENEA EXT H500-500MM
NEGRA
Prolongación
112.0683.832
7612986240917
109 €

197

KIT CHIMENEA EXT H500-990MM
NEGRA
Prolongación
112.0683.833
7612986240924
89 €

169

CHIMENEA REDONDA
SMART DECO
Tubo redondo
112.0549.122
7612985549554
260 €

Cubetas

Fregaderos

Grifos

Campanas

Electrodomésticos

Gestión de residuos

Accesorios

Accesorios

Gestión de Residuos



172

CUBO TROLLEY 8 LITROS

Cubo
133.0016.359
 7612211069054
35 €



173

CUBO TROLLEY 18 LITROS

Cubo
133.0016.358
 7612211069061
48 €



174

TAPA CUBO 18L TROLLEY VARIO

Tapa
133.0014.739
 7612211068668
31 €



178

TAPA PARA CUBO 12 L

Tapa
133.0200.695
 7612980660445
7 €



179

TAPA PARA CUBOS 18 L

Tapa
133.0284.696
 7612981051815
11 €



180

TAPA PARA CUBOS CON CARBÓN ACTIVO 8L

Tapa
133.0200.698
 7612980660452
18 €



181

TAPA PARA CUBOS CON CARBÓN ACTIVOS 18L

Tapa
133.0284.697
 7612981051822
17 €



175

TAPA CUBO 8L TROLLEY VARIO 45-60-90

Tapa
133.0014.278
 7612211068200
19 €



176

TAPA CUBO 8L

Tapa
133.0200.694
 7612980660438
15 €



177

TAPA PARA CUBO CON CARBÓN ACTIVO 12L

Tapa
133.0200.699
 7612980660476
19 €



182

TAPA PARA CUBO 14 L

Tapa
133.0028.395
 7612980010868
29 €



184

TAPA PARA CUBO 7 L

Tapa
133.0039.804
 7612980015979
19 €



185

CLIPS DE COLORES VERDE, AMARILLO Y AZUL

Clips
133.0016.354
 7612211069344
15 €

Accesorios Box Center



186

**SOPORTE CUCHILLOS 429x180x23
BOX CENTER**
Accesorios Box Center
112.0539.135
7612985515269
81 €



189

**ESCURRIDOR 452x245x165
BOX CENTER**
Accesorios Box Center
112.0539.138
7612985515290
41 €



42

**TABLA MADERA 429x180x24
BOX CENTER**
Accesorios Box Center
112.0539.134
7612985515252
99 €



26

**CUBETILLA INOX BOX
Accesorios Box Center**
112.0394.981
7612981698713
68 €



188

SET 3 CUCHILLOS BOX CENTER
Accesorios Box Center
112.0545.792
7612985538138
26 €



45

**TABLA CORTE NEGRA 429x180x24
BOX CENTER**
Accesorios Box Center
112.0539.120
7612985515245
91 €

Accesorios Hornos



192

**KIT GUIA TELESCOPICA
HORNO 73 LT**
Kit Guia
112.0624.895
7612985884884
45 €



193

**KIT GUIA TELESCOPICA
HORNO 71 LT**
Kit Guia
112.0624.354
7612985883337
43 €



194

SET GUIAS TELESCOPICAS 1 NIVEL
Kit Guia
112.0494.291
7612981921781
43 €

Cubetas

Fregaderos

Grifos

Campanas

Electrodomésticos

Gestión de residuos

Accesorios

Productos de Limpieza

Descubre la gama completa de limpieza Franke, creada para proteger nuestros productos y mantenerlos como el primer día.

Productos multiuso



KITCHEN CARE
Paño de microfibra
112.0530.324
7612985477994
12 €



MAGIC ESPONGE
Para fregadero Fraganite
Set 3 unidades
112.0304.193
7612981144746
16 €



TWISTER
1 x 125 ml con esponja
112.0007.715
7612211041975
16 €

Fregadero



KITCHEN CARE
Fregaderos de acero inox 200 ml
112.0530.237
7612985477925
19 €



KITCHEN CARE
Fregaderos color 250 ml
112.0530.238
7612985477932
17 €

Placas y Campanas

Grifos



KITCHEN CARE
Placas de cocción y campanas 250 ml
112.0530.240
7612985477956
19 €



KITCHEN CARE
Grifería 250 ml
112.0530.239
7612985477949
17 €

Limpieza y Mantenimiento

Acero inoxidable

Por naturaleza el acero inoxidable es vulnerable a las marcas de rayado que se van integrando en el fregadero con el paso del tiempo.



Más información



LIMPIEZA DIARIA

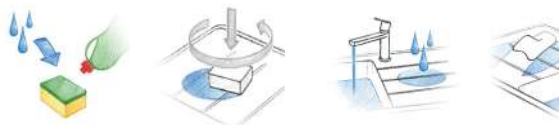

¿Qué debo evitar?

No usar estropajo de lana de acero abrasivos ni detergentes en polvo
No usar el fregadero como superficie de corte
Evitar golpes y caídas de objetos que puedan provocar rayadas
Evitar productos de limpieza que contengan cloro o estén compuestos de lejía, ácido clorhídrico o agentes descalcificadores
Evitar almacenar productos de limpieza debajo del fregadero

Tectonite



Más información



LIMPIEZA DIARIA



Manchas rebeldes: Producto de limpieza desengrasante, jabón lavavajillas, vinagre blanco (mejor para cal) o una solución de lejía suave.

Manchas de agua dura, limpiar en seco con un paño de cocina limpio y suave después de cada uso.

¿Qué debo evitar?

Evitar el uso de almohadillas de lana de acero, ya que podrían dejar pequeñas partículas que pueden causar manchas de óxido.
Evitar el contacto de utensilios a alta temperatura, utilizar protector Limpieza regular y evitar líquido o polvo abrasivo, desatascadores altamente concentrados o limpiadores para accesorios de grifos y acero

Fragranite



Más información



LIMPIEZA DIARIA



Manchas rebeldes: Producto de limpieza **desengrasante**, jabón lavavajillas, vinagre blanco (mejor para cal) o una solución de lejía suave.

¿Qué debo evitar?

Evitar corta directamente encima del fregadero
Evitar el contacto de utensilios a alta temperatura, utilizar protector Limpieza regular y evitar líquido o polvo abrasivo, desatascadores altamente concentrados o limpiadores para accesorios de grifos y acero

Solid surface

LIMPIEZA DIARIA



LIMPIEZA MÁS INTENSA



LIMPIEZA A FONDO (recomendable cada 4-5 semanas)



Cualquier daño producido por golpes, productos químicos o quemaduras puede ser reparado fácilmente por profesionales de Franke Solid Surface.

Electrodomésticos

Aquí encontrarás videos y los productos adecuados para limpiar tus electrodomésticos Franke.

Más información



Fraceram



Más información



LIMPIEZA DIARIA





















Manchas metálicas: Limpiadores que se emplean para encimeras de vitrocerámica o productos para pulir las superficies de automóviles.

Accede a los esquemas y tablas técnicas



**ESCANEANDO
ESTE CÓDIGO**

Cubetas y Fregaderos

 Material Fraganite	 Encastre	 Sifón	 Conjunto de fijación
 Material Tectonite	 Bajo encimera	 Válvula pulsable	 Fregaderos 2 orificios pre perforados Ø 35 mm
 Garantía de por vida (excluyendo la válvula)	 Sobre bastidor	 Válvula giratoria	 Conjunto desagüe
 Sanitized®.	 Reversible	 Válvula 3 1/2"	 N° de agujeros
 A ras	 Radio de la cubeta	 Fast Fix	













Campanas

 Sound Pro: Nivel sonoro	 Clasificación energética ventilador	 Nivel sonoro	 App Franke @Home
 Clasificación energética luz	 Clasificación energética filtros	 Función 24h	













Hornos

 Pirolítico	 Grill	 Precalentar	 Full Menu
 Hidrolítico	 Turbo Grill	 Pizza	 Guías telescópicas
 Convencional	 Maxi Cooking	 Pan Automático	 Smooth2close
 Cocción superior	 Ventilador asistencia inferior	 Pan	 Press to clean
 Cocción inferior	 Descongelar	 Patelería Automático	 Eco Hot Air
 Cocción ventilada	 Aire forzado vapor	 Quick Cooking	 Mantener caliente
 Aire forzado Eco	 Cookassist	 Fermentar	 Capacidad
 Aire forzado	 Multicooking	 Vapor	

Microondas

 Descongelar Automático	 Aire Forzado combinado	 Vapor	 Microondas
 Aire forzado Automático	 Grill combinado	 Grill	 Full Menu
 Recalentar Automático	 Turbo Grill combinado	 Precalentar	 Capacidad











Placas

 Flex Pro	 Fuego lento / Pochar	 Función uso cafetera Moka	 Hierro fundido
 Easy Cook	 Hervir	 Temporizador	
 Pro Cook	 Saltear / Freír	 Zona puente	
 Añadir Olla	 Grill / Gratinar	 Válvula de seguridad	
 Baño maría / Derretir	 Mantener caliente	 Encendido electrónico	

Lavavajillas

 Door Opening System	 Extradry	 Autolimpieza del filtro	 Puerta deslizante
 Multizone	 Programa desinfección	 Rápido 30	 Luz en el suelo
 Media carga	 Turbo	 Zócalo de 2 cm	

Frío

 No-Frost	 Multiflow	 Super cool	 Control de humedad
 Fast freeze	 Vacaciones	 Ionizer	 Botellero
 Easy Frost	 Compartimento 0°C	 Filtro de carbón activo	 Decibelios
 Eco			



Franke España, SAU
Avda. Vía Augusta 85-87
08174 Sant Cugat del Vallés
Barcelona-España
T. 93 565 35 35

www.franke.com/es